

UNCLASSIFIED



**NONRESIDENT
TRAINING
COURSE**



June 2014

**Navy Electricity and
Electronics Training
Series**

Module 24-Fiber Optics

NAVEDTRA 14196A

S/N 0504LP1139777

Notice: NETPDTC is no longer responsible for the content accuracy of the NRTCs.

For content issues, contact the servicing Center of Excellence:
Center for Surface Combat Systems; (540) 284-1061 or DSN: 234.

For course registration, issues, or login issues contact the NRTC
Helpdesk at: 1-877-264-8583 DSN: 922-1511 or Email: NRTC@navy.mil

DISTRIBUTION STATEMENT A: Approved for public release;
distribution is unlimited.

UNCLASSIFIED

UNCLASSIFIED

Although the words “he,” “him,” and “his” are used sparingly in this course to enhance communication, they are not intended to be gender driven or to affront or discriminate against anyone.

DISTRIBUTION STATEMENT A: Approved for public release; distribution is unlimited.

UNCLASSIFIED

PREFACE

By enrolling in this self-study course, you have demonstrated a desire to improve yourself and the Navy. Remember, however, this self-study course is only one part of the total Navy training program. Practical experience, schools, selected reading, and your desire to succeed are also necessary to successfully round out a fully meaningful training program.

THE COURSE: This self-study course is organized into subject matter areas, each containing learning objectives to help you determine what you should learn along with text and illustrations to help you understand the information. The subject matter reflects day-to-day requirements and experiences of personnel in the rating or skill area. It also reflects guidance provided by Enlisted Community Managers (ECMs) and other senior personnel, technical references, instructions, etc., and either the occupational or naval standards, which are listed in the *Manual of Navy Enlisted Manpower Personnel Classifications and Occupational Standards*, NAVPERS 18068.

THE QUESTIONS: The questions that appear in this course are designed to help you understand the material in the text.

VALUE: In completing this course, you will improve your military and professional knowledge. Importantly, it can also help you study for the Navy-wide advancement in rate examination. If you are studying and discover a reference in the text to another publication for further information, look it up.

2013 Edition

Published by
Center for Surface Combat Systems (CSCS)

NAVSUP Logistics Tracking Number
0504-LP-113-9777

Sailor's Creed

“I am a United States Sailor.

I will support and defend the
Constitution of the United States of
America and I will obey the orders of those
appointed over me.

I represent the fighting spirit of the Navy
and those who have gone before me to
defend freedom and democracy around the
world.

I proudly serve my country's Navy combat
team with honor, courage and commitment.

I am committed to excellence and the fair
treatment of all.”

TABLE OF CONTENTS

CHAPTER	PAGE
1 Background on Fiber Optics.....	1-1
2 Fiber Optic Concepts.....	2-1
3 Optical Fibers and Cables.....	3-1
4 Optical Splices, Connectors, and Couplers.....	4-1
5 Fiber Optic Measurement Techniques.....	5-1
6 Optical Sources and Fiber Optic Transmitters.....	6-1
7 Optical Detectors and Fiber Optic Receivers.....	7-1
8 Fiber Optic Links.....	8-1
APPENDIX	
A Abbreviations and Acronyms.....	A-1
B References Used To Develop the TRAMAN.....	B-1

Course Assignments follow Appendix B

NAVY ELECTRICITY AND ELECTRONICS TRAINING SERIES

The Navy Electricity and Electronics Training Series (NEETS) was developed for use by personnel in many electrical and electronic-related Navy ratings. Written by, and with the advice of, senior technicians in these ratings, this series provides beginners with fundamental electrical and electronic concepts through self-study. The presentation of this series is not oriented to any specific rating structure, but is divided into modules containing related information organized into traditional paths of instruction.

The series is designed to give small amounts of information that can be easily digested before advancing further into the more complex material. For a student just becoming acquainted with electricity or electronics, it is highly recommended that the modules be studied in their suggested sequence.

Considerable emphasis has been placed on illustrations to provide a maximum amount of information. In some instances, knowledge of basic algebra may be required.

Course descriptions and ordering information may be found at <https://www.netc.navy.mil> then click on the Programs tab, then select the Nonresident Training Courses from the list.

Throughout the text of this course and while using technical manuals associated with the equipment you will be working on, you will find the below notations at the end of some paragraphs. The notations are used to emphasize that safety hazards exist and care must be taken or observed.

WARNING

AN OPERATING PROCEDURE, PRACTICE, OR CONDITION, ETC., WHICH MAY RESULT IN INJURY OR DEATH IF NOT CAREFULLY OBSERVED OR FOLLOWED.

CAUTION

AN OPERATING PROCEDURE, PRACTICE, OR CONDITION, ETC., WHICH MAY RESULT IN DAMAGE TO EQUIPMENT IF NOT CAREFULLY OBSERVED OR FOLLOWED.

NOTE

An operating procedure, practice, or condition, etc., which is essential to emphasize.

STUDENT FEEDBACK AND QUESTIONS

We value your suggestions, questions, and criticisms on our courses. If you would like to communicate with us regarding this course, we encourage you, if possible, to use e-mail or to post your comments on the Community of Practice (COP) page located at <https://wwwa.nko.navy.mil/portal/home/>. If you write or fax, please use a copy of the Student Comment form that follows this page.

For subject matter questions:

E-mail: dlgr_cscs_pqs@navy.mil

Phone: Comm: 540-284-1061

DSN: 234-4639

Address:

COMMANDING OFFICER

Center for Surface Combat Systems

5395 First St

Dahlgren, VA 22448-5200

Student Comments

Course Title: NEETS Module 24-Fiber Optics

NAVEDTRA: 14196A **Date:** _____

We need some information about you:

Rate/Rank and Name: _____ Command/Unit: _____

Street Address: _____ City: _____ State/FPO: _____ Zip _____

Your comments, suggestions, etc.:

Privacy Act Statement: Under authority of Title 5, USC 301, information regarding your military status is requested in processing your comments and in preparing a reply. This information will not be divulged without written authorization to anyone other than those within DOD for official use in determining performance.

This page left intentionally blank.

CHAPTER 1

BACKGROUND ON FIBER OPTICS

LEARNING OBJECTIVES

Learning objectives are stated at the beginning of each chapter. These learning objectives serve as a preview of the information you are expected to learn in the chapter. The comprehensive check questions are based on the objectives. By successfully completing the NTRC, you indicate that you have met the objectives and have learned the information. The learning objectives are listed below.

Upon completing this chapter, you should be able to do the following:

1. Describe the term fiber optics.
2. List the parts of a fiber optic data link.
3. Understand the function of each fiber optic data link part.
4. Outline the history of fiber optic technology.
5. Describe the trade-offs in fiber properties and component selection in the design of fiber optic systems.
6. List the advantages of fiber optic systems compared to electrical communications systems.

DEFINITION OF FIBER OPTICS

Fiber optics is the branch of optical technology concerned with the transmission of radiant power (light energy) through fibers.

The difference between conventional electronic systems and fiber optic systems is how the data is sent. Fiber optics transmits (photons) light through glass fibers. Electronic systems send electrons through wire. Radio-frequency and microwave communication (including satellite links) rely on radio waves and microwaves traveling through open space or air.

In electronic systems the data is sent using analog technology. If a computer uses a 5 volt logic state, then five volts represents a logic high or “1” and zero volts represents a logic low or “0”. The combination of highs and lows (1’s and 0’s) is the data (binary code) sent. In an optical system light ON is a “1” and light OFF or dark is a “0”. This

type of transmission is called pulse code modulation (PCM). The data (pulses of light) is sent through fiber optic glass from the transmitter to the receiver. Data can be transmitted digitally (the natural form for computer data) rather than analogically.

Q1. What is fiber optics?

FIBER OPTIC DATA LINKS

A fiber optic data link sends input data through fiber optic components and provides this data as output information. It has the following three **basic functions**:

- To convert an electrical input signal to an optical signal
- To send the optical signal over an optical fiber
- To convert the optical signal back to an electrical signal

A fiber optic data link consists of four parts—**transmitter, optical fiber, connectors/splices, and receiver**. Figure 1-1 is an illustration of a fiber optic data-link connection. The transmitter, optical fiber, and receiver perform the basic functions of the fiber optic data link. Each part of the data link is responsible for the successful transfer of the data signal. A fiber optic data link needs a transmitter that can effectively convert an electrical input signal to an optical signal and launch the data-containing light down the optical fiber. A fiber optic data link also needs a receiver that can effectively transform this optical signal back into its original form. This means that the electrical signal provided as data output should exactly match the electrical signal provided as data input.

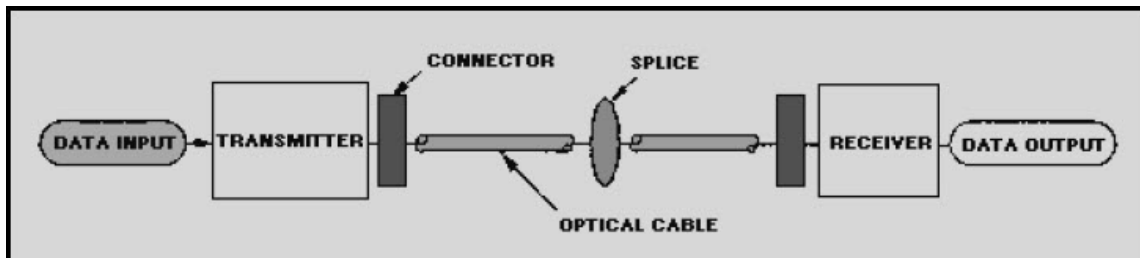

Figure 1-1. - Parts of a fiber optic data link

The basic functions of a fiber optic data link are to convert an electrical input signal to an optical signal, send the optical signal over an optical fiber, and convert the optical signal back to an electrical signal.

The purpose of the transmitter is to convert an electrical waveform or digital data stream to the best optical signal for transmission through an optical fiber. There are three

different types of optical transmitters; (1) light-emitting diodes (LEDs), (2) Vertical Cavity Surface Emitting Lasers (VCSELS) and (3) laser diodes.

Light Emitting Diodes (LED)

LEDs are relatively restricted in their range of possible applications because of their relatively low data rate and power levels. LEDs are utilized in Local Area Networks (LANs) where transmissions of less than two kilometers are required with data rates usually no more than 680Mbps/km. They are also used for control signals such as opening and closing valves and vent dampers using programmable logic controllers. Their expected operating life usually exceeds 100,000 hours or about ten years. They are simple in design, require only a few components to power, drive and monitor the device and because of their low bias voltage no cooling circuits are needed. The output power of the typical LED ranges from -15dBm to -20dBm. They operate at wavelengths of 850nm and 1300nm.

Vertical Cavity Surface Emitting Laser (VCSEL)

The VCSEL is a short range high data rate transmitter for fiber optic data links. A VCSEL because of the increased bandwidth and mode field diameter requires a 50 micron multimode laser optimized fiber as its transmission medium. The most common emission wavelengths of VCSELs are in the range of 750–980nm (often around 850nm). Data rates with VCSELs of 10Gbps can be reached over a distance of a few hundred meters.

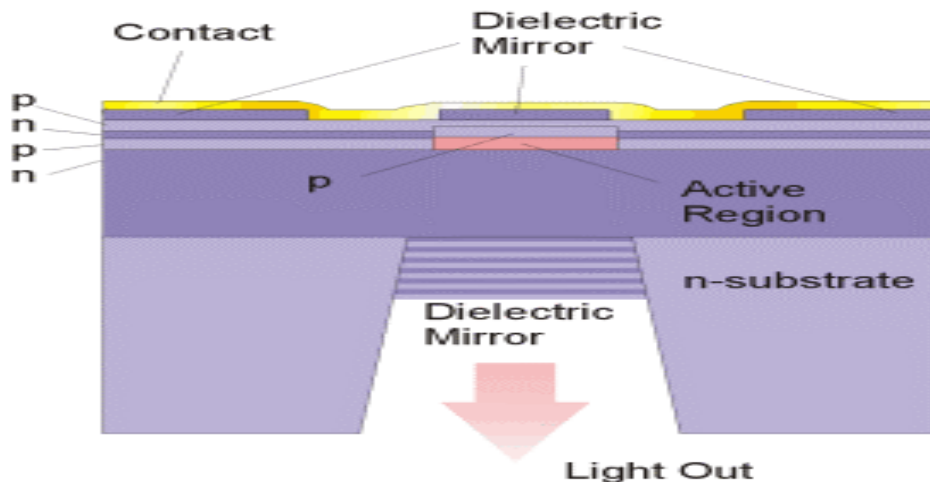

Figure 1-2. - Vertical Cavity Surface Emitting Laser

Light Amplification by Stimulated Emission of Radiation (LASER)

Laser diodes come in many shapes, sizes and operating characteristics. Lasers provide stimulated emission rather than the simpler spontaneous emission of LEDs. The main difference between an LED and a Laser is that the Laser has an optical cavity

required for lasing (See figure 1-3 below). This cavity, called the Fabry-Perot cavity, is formed by cleaving the opposite end of the chip to form a highly parallel, reflective mirror like finish.

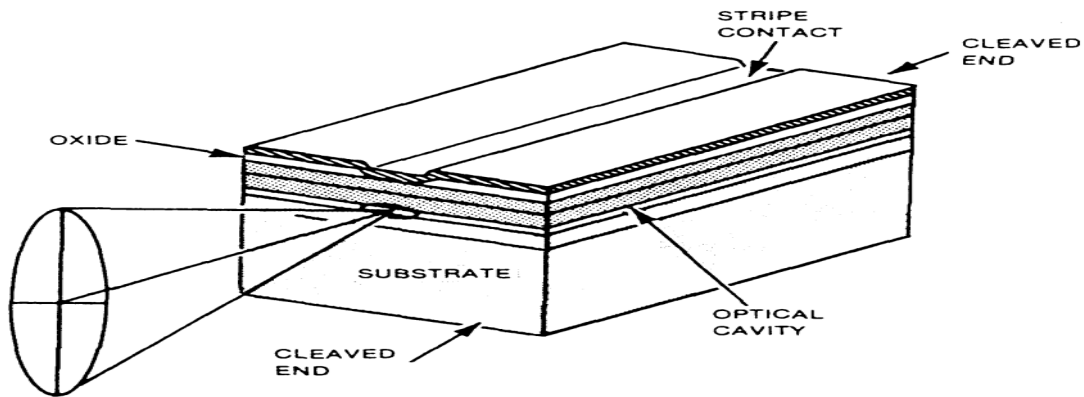

Figure 1-3. - Laser Diode

At low drive currents, the LASER acts like a LED and emits spontaneous light. As the current increases it reaches the threshold level above which lasing action begins. Some of the photons emitted by the spontaneous action are trapped in the optical cavity, reflecting back and forth from end mirror to end mirror. If one of these photons influences an excited electron, the electron immediately recombines and gives off a photon. Remember that the wavelength of a photon is a measure of its energy. The photon created is a duplicate of the first photon. It has the same wavelength, phase, and direction of travel. In other words, the incident photon has stimulated the emission of another photon and in effect, it cloned itself. Amplification has occurred, and emitted photons have stimulated further emissions. Although some of the photons remain trapped in the cavity, reflecting back and forth and stimulating further emissions, others escape through the two cleaved end faces in an intense beam of light. Thus, the LASER differs from a LED in that LASER light has the following attributes:

NEARLY MONOCHROMATIC: The light emitted has a narrow band of wavelengths. It is nearly monochromatic, which means a single wavelength. In contrast to the LED, LASER light is not continuous across the band of its spectral width. Several distinct wavelengths are emitted on either side of the central wavelength (refer to Figure 1-4). **COHERENT:** The light wavelengths are in phase, rising and falling through the sine cycle at the same time. **HIGHLY DIRECTIONAL:** The light is emitted in a highly directional pattern with little divergence. Divergence is the spreading of a light beam as it travels from its source.

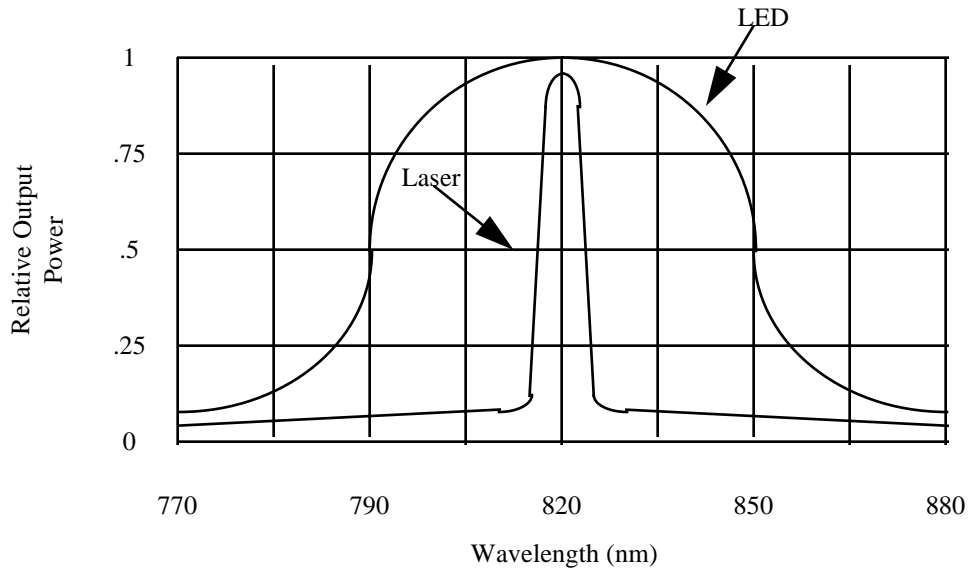

Figure 1-4. - LED vs. Laser pulse width

The LASER output power can be as high as 20mW. Not only is the light more powerful than a LED's, but the narrow beam allows the greater percentage to be coupled into the fiber. The Laser can be turned on and off faster than a LED, making the LASER usable at data rates of 300 MHz and higher. Nevertheless, the LASER suffers a few drawbacks: first, it is very expensive. Second, it is temperature sensitive and requires more complex electronic circuitry to operate. Last, it is less reliable and has a shorter expected life time than an LED.

DETECTORS

The detector serves the opposite function from the source: It converts optical energy to electrical energy. The output circuitry of the receiver amplifies the signal and accurately reproduces the original digital signal. A variety of detector types are available. The most common is the photodiode, which produces current in response to incident light. Two types of photodiodes used extensively in fiber optics are the PIN photodiode and the Avalanche (APD) photodiode. They usually involve the following considerations:

SENSITIVITY: How well does it receive incoming light signal, especially weak ones?

SPEED: How fast does it respond to light pulses? How fast does it turn off and on?

COMPLEXITY: Does it require a complex electronic bias circuit?

COMPATIBILITY: Does it respond well to the wavelengths received?

COST: Do the increased benefits justify the cost?

When light falls on the diode it creates current in the external circuit. Absorbed photons excite electrons from the valence band to the conduction band, a process known as intrinsic absorption. The result is the creation of an electron hole pair. These carriers, under the influence of the bias voltage applied to the diode, drift through the material and

induce a current in the external circuit. For each electron hole pair thus created, an electron is set flowing as current in the external circuit. As a result, the output current of the detector is proportional to the input light intensity.

PIN PHOTODIODE

The PIN photodiode has a lightly doped intrinsic layer which separates the more heavily doped p-material with free electrons or p-material with holes. Although the intrinsic layer is actually lightly doped positive, the doping is light enough to allow the layer to be considered intrinsic (neither strongly n or p-type). The name of the diode comes from this layering of materials: **Positive, Intrinsic, Negative (PIN)**.

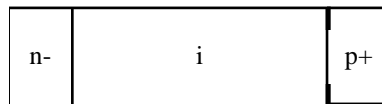

Figure 1-5. - PIN Photodiode

Since the intrinsic layer has no free carriers, its resistance is high, and electrical forces are strong within it. The resulting depletion region is very large in comparison to the size of the diode. The PIN diode works like the pn diode. The large intrinsic layer, however, means that most of the photons are absorbed within the depletion region. The result is improved efficiency in incident photons, creating external current and faster speed. Carriers created within the depletion region are immediately swept by the electric field toward their p or n terminal. The PIN photodiode provides no gain. Also, it must receive a fairly strong signal, due to its characteristics of not being very sensitive. However, the PIN photodiode has several advantages. It is easy to use, has a fast response time, and is fairly inexpensive. All detectors require bias voltage, and the PIN photodiode only requires biasing of 5 volts.

AVALANCHE PHOTODIODE

For a PIN photodiode, each absorbed photon ideally creates one electron hole pair, which sets one electron flowing in the external circuit. In this sense we can loosely compare it to a LED. There is basically a one-to-one relationship between photons and carriers and current. In a Laser, a few primary carriers result in many emitted photons. In an Avalanche Photodiode (APD), a few incident photons will set a number of carrier electrons in motion, a phenomenon known as the avalanche effect, and produce an appreciable external current (or current gain).

The structure of the APD creates a very strong electrical field in a portion of the depletion region. Primary carriers, the free electrons and holes created by absorbed photon, within this field are accelerated by the field, thereby gaining several electron volts of Kinetic energy. A collision of these fast carriers with neutral atoms causes the carrier to use some of its energy to raise a bound electron from the valence band to the conduction band. A free electron and hole appear. Carriers created in this way, through collision with a primary carrier, are called secondary carriers.

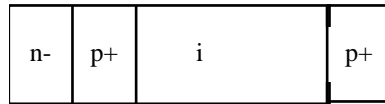

Figure 1-6. - APD Avalanche Photodiode

This process of creating secondary carriers is known as collision ionization. A primary carrier can create several new secondary carriers, and secondary carriers themselves can accelerate and create new carriers. The whole process is called photo multiplication, which is a form of gain. The multiplication or avalanche factor varies with the bias voltage. Because the accelerating forces must be strong enough to impart energies to the carriers, high bias voltages (several hundred volts) are required to create the high field region. The APD is about 10 times more sensitive and can respond better to faster incoming light signals than the PIN photodiode. The APD's increased sensitivity makes it more expensive than the PIN. In addition the APD is very sensitive to variations in temperature and requires cooling devices and compensating circuitry.

Chapter 6 provides further explanation of optical sources. Chapter 7 provides further explanation of optical detectors.

A fiber optic data link also includes passive components other than an optical fiber. Figure 1-1 does not show the optical connections used to complete the construction of the fiber optic data link. Passive components used to make fiber connections affect the performance of the data link. These components can also prevent the link from operating. Fiber optic components used to make the optical connections include optical splices, connectors, and couplers. Chapter 4 outlines the types of optical splices, connectors, and couplers and their connection properties that affect system performance.

Proof of link performance is an integral part of the design, fabrication, and installation of any fiber optic system. Various measurement techniques are used to test individual parts of a data link. Each data link part is tested to be sure the link is operating properly. Chapter 5 discusses testing methods and measurements used to qualify a fiber optic link and measure performance.

Q2. Describe the basic functions of a fiber optic data link.

Q3. List the four parts of a fiber optic data link.

Q4. What types of transmitters are used in a fiber optic network?

Q5. What types of receivers are used in a fiber optic network?

HISTORY OF FIBER OPTIC TECHNOLOGY

The earliest attempts to communicate via light undoubtedly go back thousands of years. Early long distance communication techniques, such as "smoke signals", developed by native North Americans and the Chinese were, in fact, optical communication links. A larger scale version of this optical communication technique was the "optical telegraph" developed by Claude Chappe and deployed in France in the late 18th century. However, the development of fiber optic communication awaited the discovery of TIR (Total Internal Reflection) and a host of additional electronic and optical innovations.

In 1854, John Tyndall, using a jet of water that flowed from one container to another and a beam of light, demonstrated that light used internal reflection to follow a specific path. As water poured out through the spout of the first container, Tyndall directed a beam of sunlight at the path of the water. The light, as seen by the audience, followed a zigzag path inside the curved path of the water. This simple experiment, illustrated in Figure 1-7, marked the first research into the guided transmission of light.

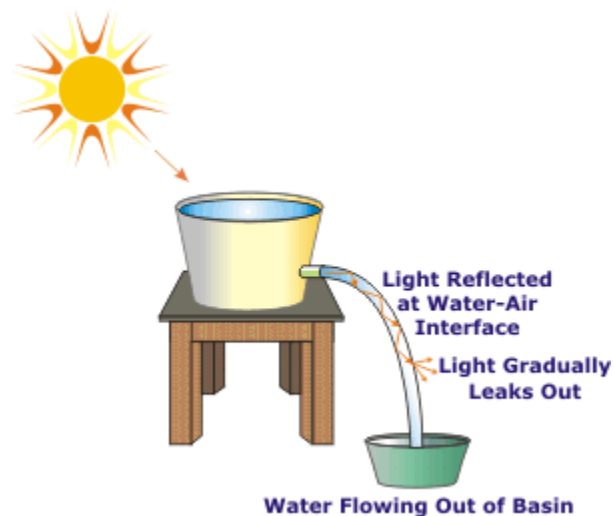

Figure 1-7. - Early TIR (Total Internal Reflection) Demonstration

People have used light to transmit information for hundreds of years. However, it was not until the 1960s, with the invention of the laser that widespread interest in optical (light) systems for data communications began. The invention of the laser prompted researchers to study the potential of fiber optics for data communications, sensing, and other applications. Laser systems could send a much larger amount of data than telephone, microwave, and other electrical systems. The first experiment with the laser

involved letting the laser beam transmit freely through the air. Researchers also conducted experiments letting the laser beam transmit through different types of waveguides. Glass fibers, gas-filled pipes, and tubes with focusing lenses are examples of optical waveguides.

Charles Kao and Charles Hockham, working at the Standard Telecommunication Laboratory in England in 1966, published a landmark paper proposing that optical fiber might be a suitable transmission medium if its attenuation could be kept under 20 decibels per kilometer (dB/km). At the time of this proposal, optical fibers exhibited losses of 1,000 dB/km or more. Even at a loss of only 20 dB/km, 99% of the light would still be lost over only 3,300 feet. In other words, only 1/100th of the optical power that was transmitted reached the receiver. But, even with this loss, the power was enough to drive the receiver.

A decibel is a ratio of output power compared to the input power or mathematically, $\text{dB} = 10 \log (\text{output}/\text{input})$. The decibel is the unit of measurement used in optics to describe loss or attenuation. Loss is the difference in power between the transmitter and the receiver measured in dB.

The problem was developing a process in glass manufacturing to achieve the 20 dB threshold. Intuitively, researchers postulated that the current, higher optical losses were the result of impurities in the glass and not the glass itself. An optical loss of 20 dB/km was within the capability of the electronics and optoelectronic components of the day.

Intrigued by Drs. Kao and Hockham's proposal, glass researchers began to work on the problem of purifying glass. In 1970, Drs. Robert Maurer, Donald Keck, and Peter Schultz of Corning Glass Works succeeded in developing a glass fiber that exhibited attenuation at less than 20 dB/km, the threshold for making fiber optics a viable technology. It was the purest glass ever made.

There are two basic types of optical fibers, multimode fibers and single mode fibers. Chapter 2 discusses the differences between the fiber types. In 1972, Corning made a high silica-core multimode optical fiber with 4dB/km minimum loss. Currently, multimode fibers can have losses as low as 0.5 dB/km at wavelengths around 1300 nm. Single mode fibers are available with losses lower than 0.25 dB/km at wavelengths around 1500 nm.

The early work on fiber optic light sources and detectors was slow and often had to borrow technology developed for other reasons. For example, the first fiber optic light sources were derived from visible indicator LED's. As demand grew, light sources were developed for fiber optics that offered higher switching speed, more appropriate wavelengths, and higher output power.

Fiber optics developed over the years in a series of generations that can be closely tied to wavelength. Figure 1-8 shows three curves. The top, dashed, curve corresponds to early 1980's fiber, the middle, dotted, curve corresponds to late 1980's fiber, and the bottom, solid, curve corresponds to modern optical fiber. The earliest fiber optic systems were developed at an operating wavelength of about 850 nm. This wavelength corresponds to the so-called "first window" in a silica-based optical fiber. This window refers to a wavelength region that offers low optical loss. It sits between several large absorption peaks caused primarily by moisture in the fiber and Rayleigh scattering.

The 850 nm region was initially attractive because the technology for light emitters at this wavelength had already been perfected in visible indicator and infrared (IR) LED's. Low-cost silicon detectors could also be used at the 850 nm wavelength. As the technology progressed, the first window became less attractive because of its relatively high 3 dB/km loss limit.

Most companies jumped to the "second window" at 1310 nm with lower attenuation of about 0.5 dB/km. In late 1977, Nippon Telegraph and Telephone (NTT) developed the "third window" at 1550 nm. It offered the theoretical minimum optical loss for silica-based fibers, about 0.2 dB/km.

Today, 850nm, 1310nm, and 1550nm systems are all manufactured and deployed along with very low-end, short distance, systems using visible wavelengths near 660nm. Each wavelength has its advantage. Longer wavelengths offer higher performance, but always come with higher cost. The shortest link lengths can be handled with wavelengths of 660nm or 850nm. The longest link lengths require 1625nm wavelength systems. This fourth window was developed in 2007.

The Navy has integrated fiber optic networks into most of the current shipboard systems and platforms. From propulsion and navigation to weapons and communications systems fiber optics has become the principle means of data transfer and control signals.

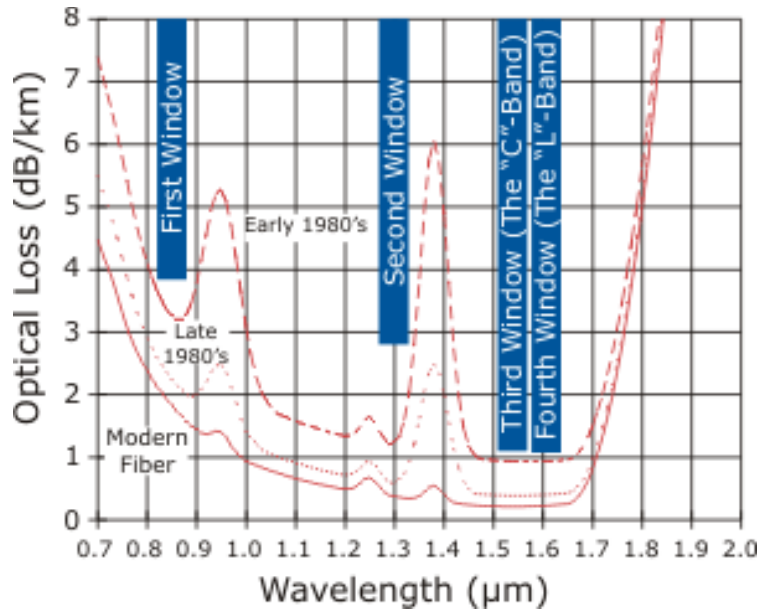

Figure 1-8. - Four Wavelength Regions of Optical Fiber

Q6. Define loss.

Q7. What percentage of power is lost at 20dB?

Q8. What wavelengths are used in the typical fiber optic system?

Q9. What are the two basic types of optical fibers?

FIBER OPTIC SYSTEMS

The U.S. military moved quickly to use fiber optics for improved communications and tactical systems. In 1973, the U.S. Navy installed a fiber optic telephone link aboard the U.S.S. Little Rock. The Air Force followed suit by developing its Airborne Light Optical Fiber Technology (ALOFT) program in 1976. Encouraged by the success of these applications, military R&D programs were funded to develop stronger fibers, tactical cables, ruggedized, high-performance components, and numerous demonstration systems ranging from aircraft to undersea applications.

Commercial applications followed soon after. In 1977, both AT&T and GTE installed fiber optic telephone systems in Chicago and Boston respectively. These successful applications led to the increase of fiber optic telephone networks. By the early 1980's, single-mode fiber operating in the 1310nm and later the 1550nm wavelength windows became the standard fiber installed for these networks. Initially, computers, information networks, and data communications were slower to embrace fiber, but today they too find use for a transmission system that has lighter weight cable, resists lightning strikes, and carries more information faster and over longer distances.

In military and commercial applications, system design and parts selection are often related. Designers consider **trade-offs** in the following areas:

- Fiber properties
- Types of connections
- Optical sources
- Detector types

Designers develop systems to meet stringent working requirements, while trying to maintain economic performance. The environment dictates the types of connectors and fibers designers select to make up the fiber optic cable plant (FOCP). The National Electric Code (NEC) and Telecommunications Industry Association (TIA) provide the guidelines for the commercial sector. While the installation standard for ships is the MIL-STD 2042B and the design standard is the MIL-STD 2052. All components installed on a navy ship or boat should be identified on the Qualified Products List or QPL. This module identifies the types of components chosen by the Navy for shipboard applications.

Future naval system designs depend on system data rates and changes to the way data is sent. Systems will use dense wave and course wave multiplexing that will increase data rates to 40 to 100 gigabits per second and within a decade rates could exceed 400 gigabits per second.

In the commercial industry broadband services allow transmission of voice, video, and data. Services include television, data retrieval, video word processing, electronic mail, banking, and shopping. Fiber to the home or FTTH is being rolled out to neighborhoods throughout the country. The bundled packages now include television, phone and internet.

Fiber optics has changed the world we live in. The ability to use debit and credit cards everywhere occurs because of fiber optic storage networks. Even in the age of wireless communications (cell phones) the only reason they work is because of the world-wide web or fiber optic network.

The transmitter in your cell phone broadcasts your voice a short distance to the nearest cell tower. Once received at the tower, it is converted to pulses of light that are sent across the country (or world) through various switches and fibers to a cell tower closest to your intended recipient. That tower converts your voice back to a wireless transmission and broadcasts it out. It is received by the cell phone it was intended to go to. Basically no matter where you are 99.99 percent of the distance your voice travels is through a fiber optic network.

Q10. When was the first commercial fiber optic network installed?

Q11. What standards are used to design and install fiber optic networks on naval ships?

Q12. In fiber optic systems, designers consider what trade-offs?

ADVANTAGES AND DISADVANTAGES OF FIBER OPTICS

Fiber optic systems have many attractive features that are superior to electrical systems. These include improved system performance, Information carrying capacity (bandwidth), immunity to electrical noise, signal security, and improved safety, reduced size and weight, and overall system economy. Table 1-1 lists the main advantages of fiber optic systems.

System Performance	<ul style="list-style-type: none"> • Greatly increased bandwidth and capacity • Lower signal attenuation (loss)
Immunity to Electrical Noise	<ul style="list-style-type: none"> • Immune to noise (electromagnetic interference [EMI] and radiofrequency interference [RFI]) • No crosstalk • Lower bit error rates
Signal Security	<ul style="list-style-type: none"> • Difficult to tap • Nonconductive (does not radiate signals)
Electrical Isolation	<ul style="list-style-type: none"> • No common ground required • Freedom from short circuit and sparks
Size and Weight	<ul style="list-style-type: none"> • Reduced size and weight cables

Environmental Protection	<ul style="list-style-type: none"> • Resistant to radiation and corrosion • Resistant to temperature variations • Improved ruggedness and flexibility • Less restrictive in harsh environments
Overall System Economy	<ul style="list-style-type: none"> • Low per-channel cost • Lower installation cost • Silica is the principle, abundant, and inexpensive material (source is sand)

Table 1-1 Advantages of Fiber Optics

Q13. List the advantages of fiber optics over electrical systems.

SUMMARY

Now that you have completed this chapter, let's review some of the new terms, concepts, and ideas you have learned. You should have a thorough understanding of these principles before advancing to chapter 2.

FIBER OPTICS is the branch of optical technology concerned with the transmission of radiant power (light energy) through fibers.

A **FIBER OPTIC DATA LINK** has three basic functions: to convert an electrical input signal to an optical signal, to send the optical signal over an optical fiber, and to convert the optical signal back to an electrical signal. It consists of four parts: transmitter, optical fiber, connectors/splices and receiver.

The **TRANSMITTER** converts the electrical input signal to an optical signal by varying the current flow through the light source.

The **RECEIVER** converts the optical signal exiting the fiber back into the original form of the electrical input signal.

ATTENUATION is the difference or loss of power sent from the transmitter to what arrives at the receiver. This loss is measured in decibels or dB.

WAVELENGTH is the distance measured in nanometers from the crest of one wave to the crest of the next. There are three primary windows that are used with fiber optics; 850nm, 1300nm and 1550nm.

The **TWO BASIC TYPES OF OPTICAL FIBERS** are multimode fibers and single mode fibers.

A **LIGHT-EMITTING DIODE (LED)** is used mainly in low data rate short haul networks. Typical output power is -15 to -20 dBm.

In **MILITARY** and **COMMERCIAL APPLICATIONS**, system designers consider tradeoffs in the following areas: fiber properties, types of connections, optical sources, and detector types.

The **ADVANTAGES** of fiber optic systems include improved system performance, increased bandwidth, immunity to electrical noise, signal security, reduced size and weight, upgradability, low loss, safety and overall system economy.

ANSWERS TO QUESTIONS Q1. THROUGH Q13.

- A1. *Fiber optics is the branch of optical technology concerned with the transmission of radiant power (light energy) through fibers.*
- A2. *The basic functions of a fiber optic data link are to convert an electrical input signal to an optical signal, send the optical signal over an optical fiber, and convert the optical signal back to an electrical signal.*
- A3. *Transmitter, optical fiber, connectors/splices and receiver.*
- A4. *LEDs, VCSELs and LASERS*
- A5. *PIN photodiodes and Avalanche (APD) photodiodes*
- A6. *Loss is the difference in power between the transmitter and the receiver measured in dB.*
- A7. *99 %*
- A8. *Multi-mode uses 850nm and 1300nm, Single-mode uses 1310nm, 1550nm and 1625nm.*
- A9. *Multimode and single mode fibers.*
- A10. *1977*
- A11. *MIL-STD 2042B and MIL-STD 2052.*
- A12. *Trade-offs in fiber properties, types of connections, optical sources, and detector types in military and subscriber-loop applications.*
- A13. *Advantages of fiber optics are information carrying capacity (Bandwidth), immunity to electrical noise (EMI), signal security, safety, reduced size and weight, low loss, and upgradability.*

CHAPTER 2

FIBER OPTIC CONCEPTS

LEARNING OBJECTIVES

Upon completion of this topic, you should be able to do the following:

1. Understand the nature of light propagation.
2. Discuss the electromagnetic theory of light.
3. Describe the properties of light.
4. Explain how optical fibers transmit light.
5. Identify the basic optical fiber material properties.
6. Describe the ray and mode theories of light propagation along an optical fiber.
7. State the difference between multimode and single mode optical fibers.
8. Explain how optical fibers attenuate and distort light signals as they travel along the optical fiber.
9. Understand the processes of light attenuation and dispersion.

INTRODUCTION

When you first learn of fiber optics you will come to realize it is a vast field and growing rapidly. Conceptually fiber optics is still in its infancy and developmental stages. Relatively speaking, one could compare it to the where the automobile industry or electrical power distribution was in the 1930's!

The exponential growth of this industry has skyrocketed in recent years. It shows no sign of slowing and more technology and industries are using this technology with increasing reliability at a higher level of performance every day. Some of the most obvious fields of use are communications and lighting. There have been huge gains however using fiber optics in security, medical, construction, production, advertising, transportation, art, toys and now clothing!

Let's look at just a couple examples how fiber optics can be used. Take construction for instance, today a bridge can be built having optical fiber embedded to measure the conditions of the bridge. In the medical industry fiber optic cables can be used to send signals to and from a person's brain to a prosthetic and back to give a higher quality of life. It doesn't matter what type of industry or how the fiber optics is utilized.

The technology uses the same conceptual ideas and principles for propagating the light. It is simply a matter of how the light is used and what message is being sent.

FIBER OPTIC LIGHT TRANSMISSION

Fiber optics deals with the transmission of light energy through transparent fibers. How an optical fiber guides light depends on the nature of the light and the structure of the optical fiber. A light wave is a form of energy that is moved by wave motion. Wave motion can be defined as a recurring disturbance advancing through space with or without the use of a physical medium. In fiber optics, wave motion is the movement of light energy through an optical fiber. To fully understand the concept of wave motion, refer to NEETS Module 10—Wave Propagation, Transmission Lines, and Antennas. Before we introduce the subject of light transmission through optical fibers, you must first understand the nature of light and the properties of light waves.

PROPAGATION OF LIGHT

The exact nature of light is not fully understood, although people have been studying the subject for many centuries. In the 1700s and before, experiments seemed to indicate that light was composed of particles. In the early 1800s, a physicist Thomas Young showed that light exhibited wave characteristics. Further experiments by other physicists culminated in James Clerk (pronounced Clark) Maxwell collecting the four fundamental equations that completely describe the behavior of the electromagnetic fields. James Maxwell deduced that light was simply a component of the electromagnetic spectrum. This seems to firmly establish that light is a wave. Yet, in the early 1900s, the interaction of light with semiconductor materials, called the photoelectric effect, could not be explained with electromagnetic wave theory. The advent of quantum physics successfully explained the photoelectric effect in terms of fundamental particles of energy called **quanta**. Quanta are known as **photons** when referring to light energy.

Today, when studying light that consists of many photons, as in propagation, that light behaves as a continuum—an electromagnetic wave. On the other hand, when studying the interaction of light with semiconductors, as in sources and detectors, the quantum physics approach is taken. The wave versus particle dilemma can be addressed in a more formal way, but that is beyond the scope of this text. It suffices to say that much has been reconciled between the two using quantum physics. In this manual, we use both the electromagnetic wave and photon concepts, each in the places where it best matches the phenomenon we are studying.

The electromagnetic energy of light is a form of electromagnetic radiation. Light and similar forms of radiation are made up of moving electric and magnetic forces. A simple example of motion similar to these radiation waves can be made by dropping a pebble into a pool of water, see figure 2-1. In this example, the water is not actually being moved by the outward motion of the wave, but rather by the up-and-down motion of the water. The up-and-down motion is transverse, or at right angles, to the outward motion of

the waves. This type of wave motion is called **transverse-wave motion**. The transverse waves spread out in expanding circles until they reach the edge of the pool, in much the same manner as the transverse waves of light spread from the sun. However, the waves in the pool are very slow and clumsy in comparison with light, which travels approximately 186,000 miles per second.



Figure 2-1. - Transverse wave

Light radiates from its source in all directions until it is absorbed or diverted by some substance, see figure 2-2. The lines drawn from the light source (a light bulb in this instance) to any point on one of the transverse waves indicate the direction that the wave fronts are moving. These lines are called **light rays**.

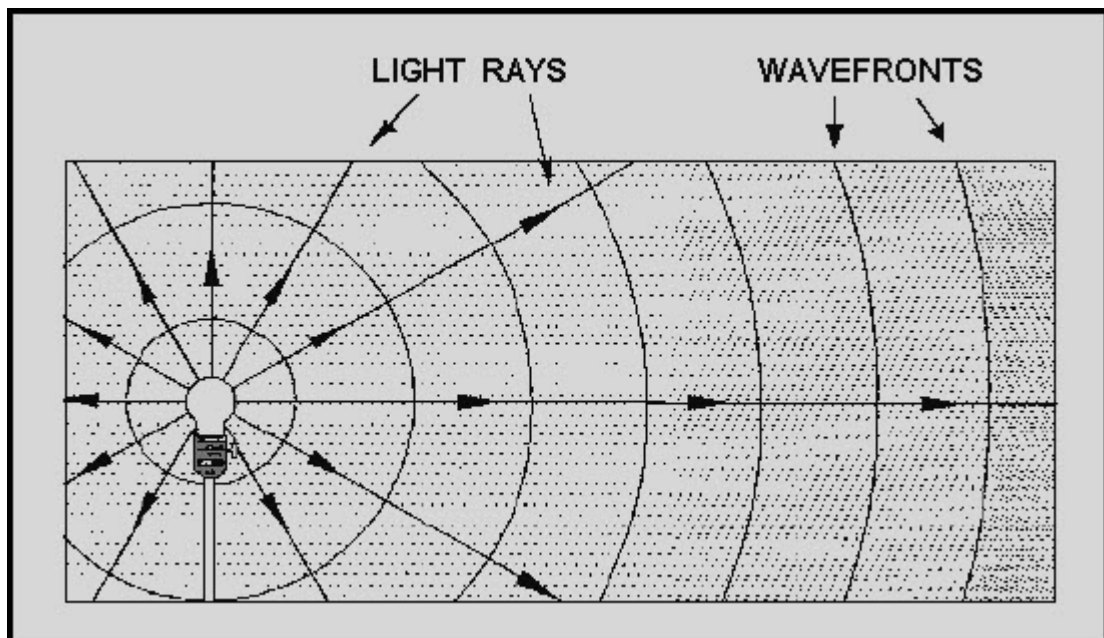

Figure 2-2. - Light rays and wave fronts from a nearby light source

Although single rays of light typically do not exist, light rays shown in illustrations are a convenient method used to show the direction in which light is traveling at any point. A ray of light can be illustrated as a straight line.

Q1. Quantum physics successfully explained the photoelectric effect in terms of fundamental particles of energy called quanta. What are the fundamental particles of energy (quanta) known as when referring to light energy?

Q2. What type of wave motion is represented by the motion of water?

PROPERTIES OF LIGHT

When light waves, which travel in straight lines, encounter any substance, they are either reflected, absorbed, transmitted, or refracted. This is illustrated in figure 2-3. Those substances that transmit almost all the light waves falling upon them are said to be **transparent**. A transparent substance is one through which you can see clearly. Clear glass is transparent because it transmits light rays without diffusing them (view A of figure 2-4). There is no substance known that is perfectly transparent, but many substances are nearly so. Substances through which some light rays can pass, but through which objects cannot be seen clearly because the rays are diffused, are called **translucent** (view B of figure 2-4). The frosted glass of a light bulb and a piece of oiled paper are examples of translucent materials. Those substances that are unable to transmit any light rays are called **opaque** (view C of figure 2-4). Opaque substances either reflect or absorb all the light rays that fall upon them.

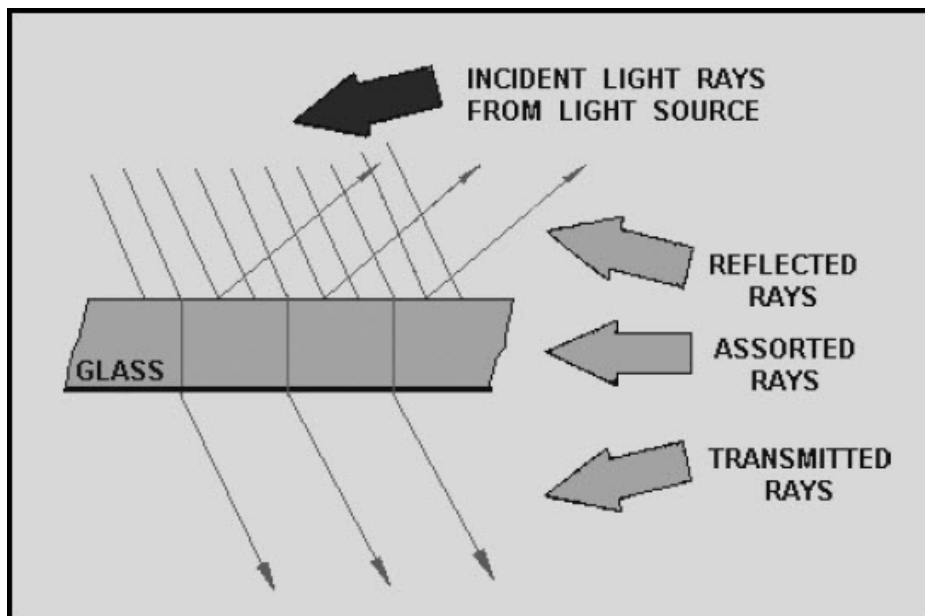

Figure 2-3. - Light waves reflected, absorbed, and transmitted

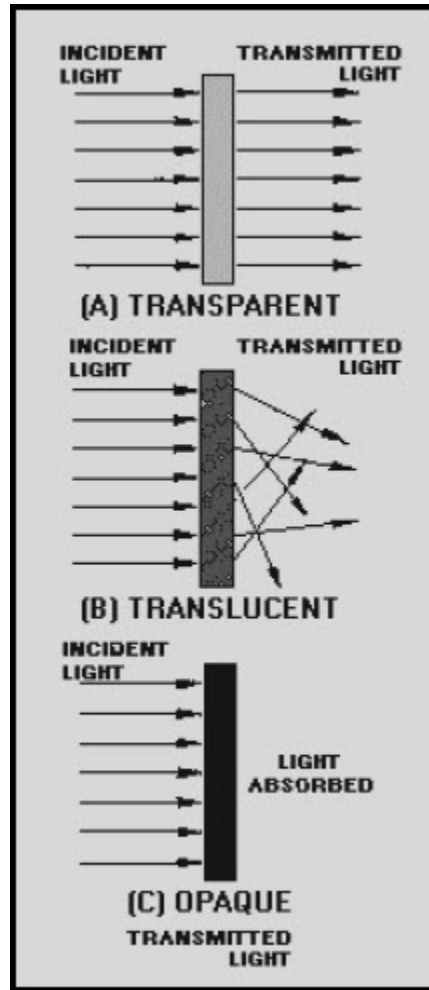

Figure 2-4. - Substances: A. Transparent; B. Translucent; and C. Opaque

All substances that are not light sources are visible only because they reflect all or some part of the light reaching them from some luminous source. Examples of luminous sources include the sun, a gas flame, and an electric light filament, because they are sources of light energy. If light is neither transmitted nor reflected, it is absorbed or taken up by the medium. When light strikes a substance, some absorption and some reflection always take place. No substance completely transmits, reflects, or absorbs all the light rays that reach its surface.

Q3. When light waves encounter any substance, what four things can happen?

Q4. A substance that transmits almost all of the light waves falling upon it is known as what type of substance?

Q5. A substance that is unable to transmit any light waves is known as what type of substance?

REFLECTION OF LIGHT

Reflected waves are simply those waves that are neither transmitted nor absorbed, but are reflected from the surface of the medium they encounter. When a wave approaches a reflecting surface, such as a mirror, the wave that strikes the surface is called the **incident** wave, and the one that bounces back is called the **reflected** wave, see figure 2-5. An imaginary line perpendicular to the point at which the incident wave strikes the reflecting surface is called the **normal**, or the perpendicular. The angle between the incident wave and the normal is called the **angle of incidence**. The angle between the reflected wave and the normal is called the **angle of reflection**.

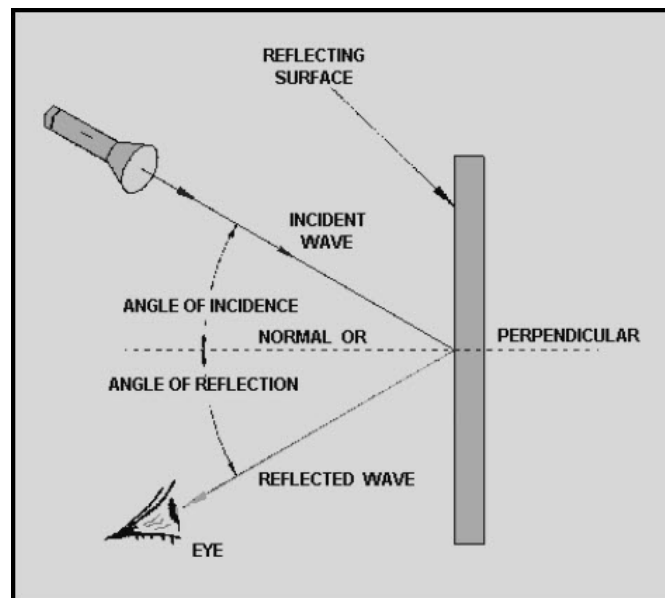

Figure 2-5. - Reflection of a wave

If the surface of the medium contacted by the incident wave is smooth and polished, each reflected wave will be reflected back at the same angle as the incident wave. The path of the wave reflected from the surface forms an angle equal to the one formed by its path in reaching the medium. This conforms to the **law of reflection** which states: The angle of incidence is equal to the angle of reflection.

The amount of incident-wave energy that is reflected from a surface depends on the nature of the surface and the angle at which the wave strikes the surface. The amount of wave energy reflected increases as the angle of incidence increases. The reflection of energy is the greatest when the wave is nearly parallel to the reflecting surface. When the incidence wave is perpendicular to the surface, more of the energy is transmitted into the

substance and reflection of energy is at its least. At any incident angle, a mirror reflects almost all of the wave energy, while a dull, black surface reflects very little.

Light waves obey the law of reflection. Light travels in a straight line through a substance of uniform density. For example, you can see the straight path of light rays admitted through a narrow slit into a darkened room. The straight path of the beam is made visible by illuminated dust particles suspended in the air. If the light is made to fall onto the surface of a mirror or other reflecting surface, however, the direction of the beam changes sharply. The light can be reflected in almost any direction, depending on the angle with which the mirror is held.

Q6. What is the law of reflection?

Q7. When a wave is reflected from a surface, energy is reflected. When is the reflection of energy the greatest?

Q8. When is the reflection energy the least?

Q9. Light waves obey what law?

REFRACTION OF LIGHT

When a light wave passes from one medium into a medium having a different velocity of propagation (the speed waves can travel through a medium), a change in the direction of the wave will occur. This change of direction as the wave enters the second medium is called refraction. As in the discussion of reflection, the wave striking the boundary (surface) is called the incident wave, and the imaginary line perpendicular to the boundary is called the normal. The angle between the incident wave and the normal is called the angle of incidence. As the wave passes through the boundary, it is bent either toward or away from the normal. The angle between the normal and the path of the wave through the second medium is the angle of refraction.

A light wave passing through a block of glass is shown in figure 2-6. The wave moves from point A to point B at a constant speed. This is the incident wave. As the wave penetrates the glass boundary at point B, the velocity of the wave is slowed down. This causes the wave to bend toward the normal. The wave then takes the path from point B to point C through the glass and becomes both the refracted wave from the top surface and the incident wave to the lower surface. As the wave passes from the glass to the air (the second boundary), it is again refracted, this time away from the normal, and takes the path from point C to point D. After passing through the last boundary, the velocity

increases to the original velocity of the wave. As illustrated, refracted waves can bend toward or away from the normal. This bending depends on the velocity of the wave through different mediums. The broken line between points B and E is the path that the wave would travel if the two mediums (air and glass) had the same density.

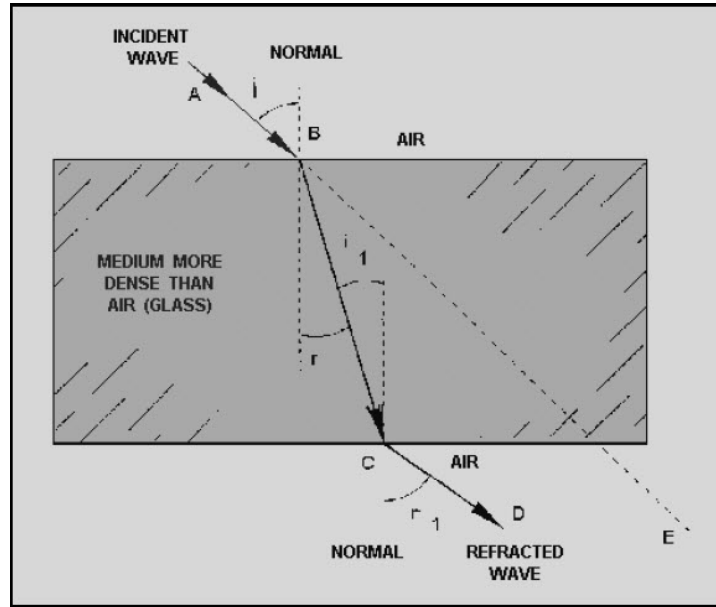

Figure 2-6. - Refraction of a wave

Another interesting condition can be shown using figure 2-6. If the wave passes from a less dense to a denser medium, it is bent toward the normal, and the angle of refraction (r) is less than the angle of incidence (i). Likewise, if the wave passes from a denser to a less dense medium, it is bent away from the normal, and the angle of refraction (r_1) is greater than the angle of incidence (i_1).

An example of refraction is the apparent bending of a spoon when it is immersed in a cup of water. The bending seems to take place at the surface of the water, or exactly at the point where there is a change of density. Obviously, the spoon does not bend from the pressure of the water. The light forming the image of the spoon is bent as it passes from the water (a medium of high density) to the air (a medium of comparatively low density).

Without refraction, light waves would pass in straight lines through transparent substances without any change of direction. Figure 2-6 shows that rays striking the glass at any angle other than perpendicular are refracted. However, perpendicular rays, which enter the glass normal to the surface, continue through the glass and into the air in a straight line—no refraction takes place.

Q10. A refracted wave occurs when a wave passes from one medium into another medium. What determines the angle of refraction?

Q11. A light wave enters a sheet of glass at a perfect right angle to the surface. Is the majority of the wave reflected, refracted, transmitted, or absorbed?

DIFFUSION OF LIGHT

When light is reflected from a mirror, the angle of reflection equals the angle of incidence. When light is reflected from a piece of plain white paper; however, the reflected beam is scattered, or diffused, as shown in figure 2-7. Because the surface of the paper is not smooth, the reflected light is broken up into many light beams that are reflected in all directions.

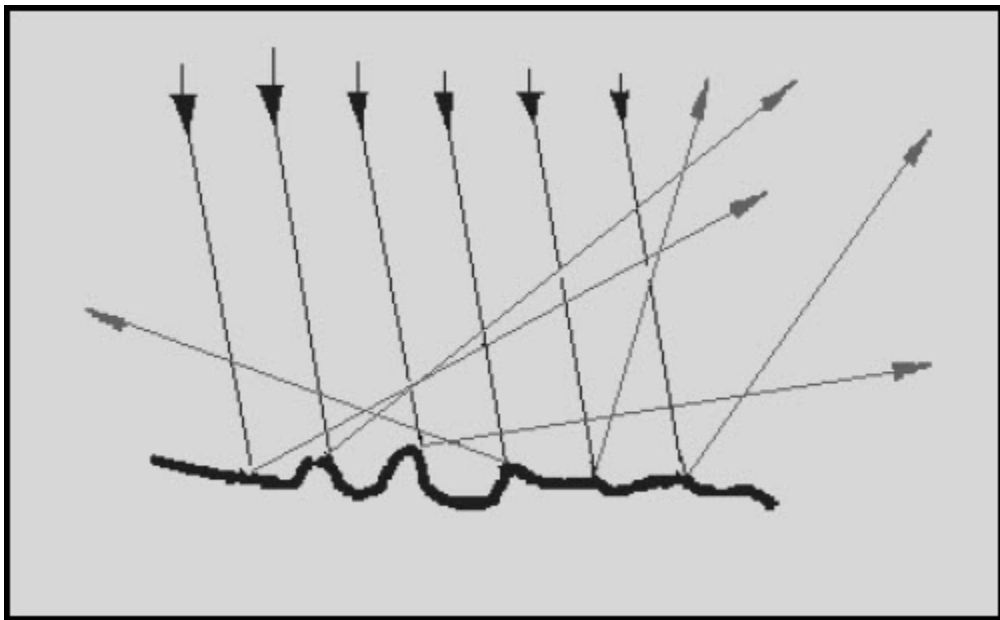

Figure 2-7. - Diffusion of light

Q12. When light strikes a piece of white paper, the light is reflected in all directions. What do we call this scattering of light?

ABSORPTION OF LIGHT

You have just seen that a light beam is reflected and diffused when it falls onto a piece of white paper. If the light beam falls onto a piece of black paper, the black paper absorbs most of the light rays and very little light is reflected from the paper. If the surface upon which the light beam falls is perfectly black, there is no reflection; that is, the light is totally absorbed. No matter what kind of surface light falls upon, some of the light is absorbed. Figure 2-7a.

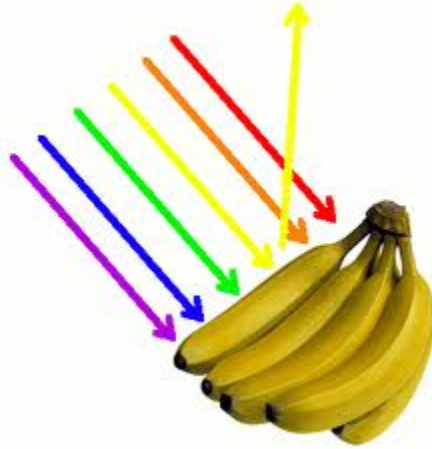

Figure 2-7a. - Absorption of light

TRANSMISSION OF LIGHT THROUGH OPTICAL FIBERS

The transmission of light along optical fibers depends not only on the nature of light, but also on the structure of the optical fiber. Two methods are used to describe how light is transmitted along the optical fiber. The first method, ray theory, uses the concepts of light reflection and refraction. The second method, mode theory, treats light as electromagnetic waves. You must first understand the basic optical properties of the materials used to make optical fibers. These properties affect how light is transmitted through the fiber.

Q13. Two methods describe how light propagates along an optical fiber. These methods define two theories of light propagation. What do we call these two theories?

BASIC OPTICAL-MATERIAL PROPERTIES

The basic optical property of a material, relevant to optical fibers, is the index of refraction. The index of refraction (n) measures the speed of light in an optical medium. The index of refraction of a material is the ratio of the speed of light in a vacuum to the speed of light in the material itself. The speed of light (c) in free space (vacuum) is 3×10^8 meters per second (m/s). The speed of light is the frequency (f) of light multiplied by the wavelength of light (λ). When light enters the fiber material (an optically dense medium), the light travels slower at a speed (v). Light will always travel slower in the fiber material than in air. The index of refraction is given by:

$$n = \frac{c}{v}$$

A light ray is reflected and refracted when it encounters the boundary between two different transparent mediums. For example, figure 2-8 shows what happens to the light ray when it encounters the interface between glass and air. The index of refraction for glass (n_1) is 1.50. The index of refraction for air (n_2) is 1.00.

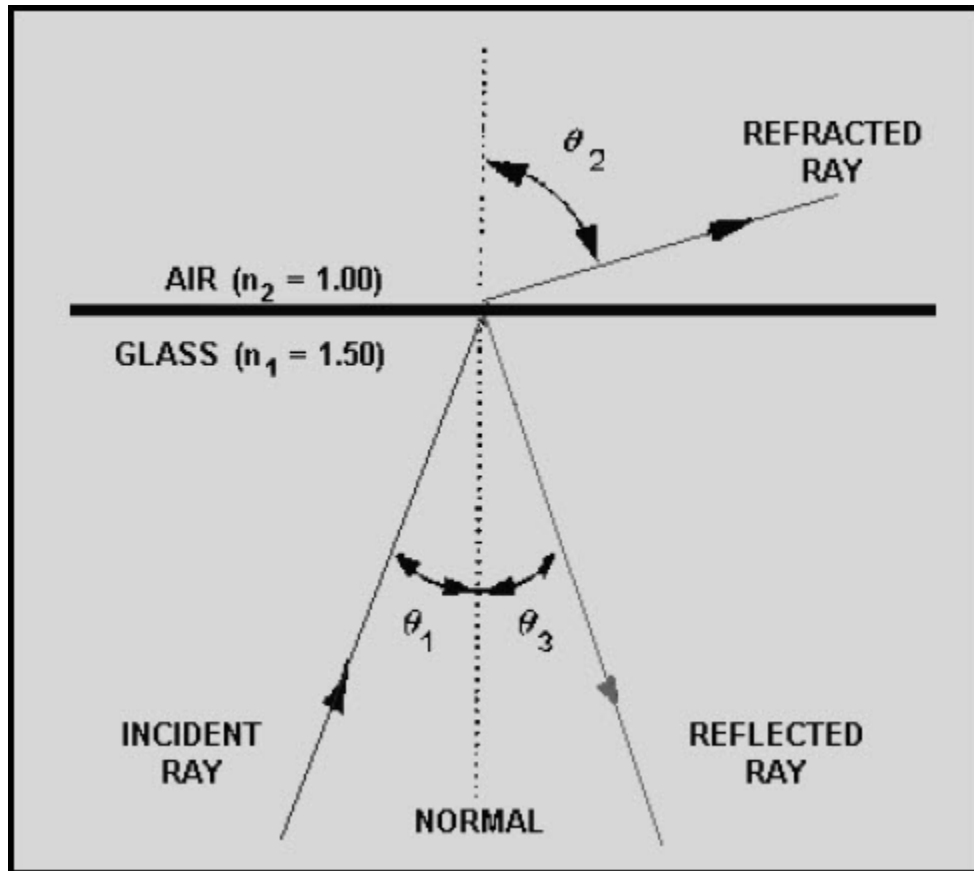

Figure 2-8. - Light reflection and refraction at a glass-air boundary

Let's assume the light ray or incident ray is traveling through the glass. When the light ray encounters the glass-air boundary, there are two results. The first result is that part of the ray is reflected back into the glass. The second result is that part of the ray is refracted (bent) as it enters the air. The bending of the light at the glass-air interface is the result of the difference between the indexes of refractions. Since n_1 is greater than n_2 , the angle of refraction (θ_2) will be greater than the angle of incidence (θ_1). Snell's law of refraction is used to describe the relationship between the incident and the refracted rays at the boundary. Snell's Law is given by:

$$n_1 \times \sin \theta_1 = n_2 \times \sin \theta_2$$

As the angle of incidence (θ_1) becomes larger, the angle of refraction (θ_2) approaches 90 degrees. At this point, no refraction is possible. The light ray is totally

reflected back into the glass medium. No light escapes into the air. This condition is called total internal reflection. The angle at which total internal reflection occurs is called the critical angle of incidence. The critical angle of incidence (θ_c) is shown in figure 2-9. At any angle of incidence (θ_1) greater than the critical angle, light is totally reflected back into the glass medium. The critical angle of incidence is determined by using Snell's Law. The critical angle is given by:

$$\sin \theta_c = \frac{n_2}{n_1}$$

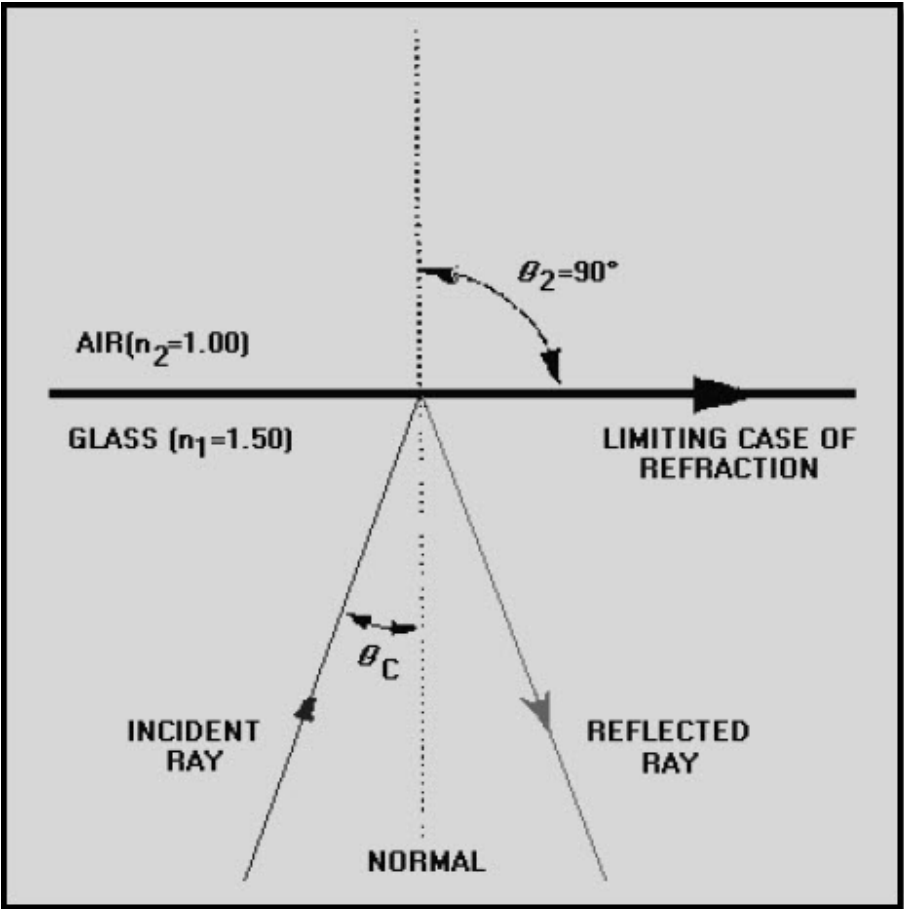

Figure 2-9. - Critical angle of incidence

The condition of total internal reflection is an ideal situation. However, in reality, there is always some light energy that penetrates the boundary. This situation is explained by the mode theory, or the electromagnetic wave theory, of light.

Q14. What is the basic optical-material property relevant to optical fiber light transmission?

Q15. The index of refraction measures the speed of light in an optical fiber. Will light travel faster in an optically dense material or in one that is less dense?

Q16. Assume light is traveling through glass, what happens when this light strikes the glass-air boundary?

Q17. What condition causes a light ray to be totally reflected back into its medium of propagation?

Q18. What name is given to the angle where total internal reflection occurs?

BASIC STRUCTURE OF AN OPTICAL FIBER

The basic structure of an optical fiber consists of three parts; the core, the cladding, and the coating or buffer. The basic structure of an optical fiber is shown in figure 2-10. The core is a cylindrical rod of dielectric material. Dielectric material conducts no electricity. Light propagates mainly along the core of the fiber. The core is generally made of glass. The core is described as having a radius of (a) and an index of refraction n_1 . The core is surrounded by a layer of material called the cladding. Even though light will propagate along the fiber core without the layer of cladding material, the cladding does perform some necessary functions.

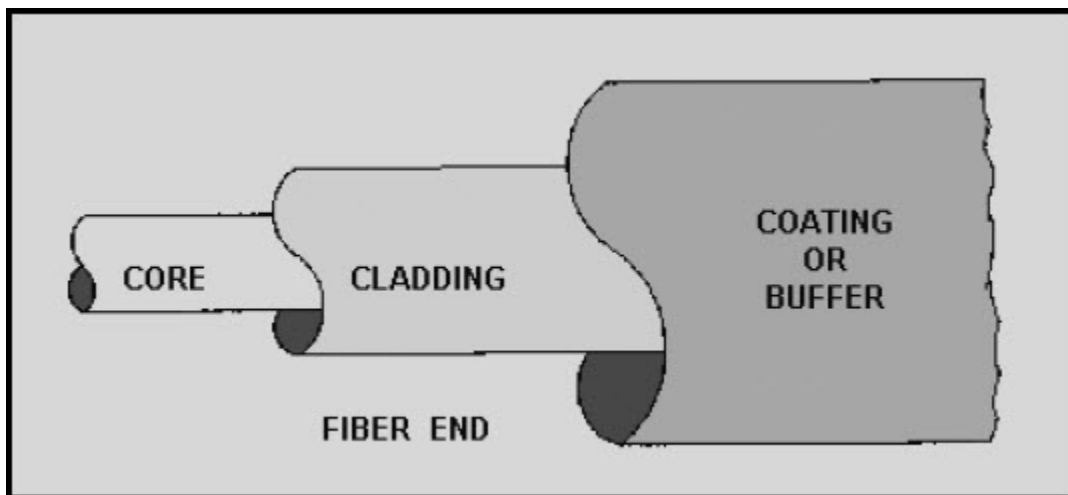

Figure 2-10. - Basic structure of an optical fiber

The cladding layer is made of a dielectric material with an index of refraction n_2 . The index of refraction of the cladding material is less than that of the core material. The

cladding is generally made of glass or plastic. The cladding performs the following functions:

- Reduces loss of light from the core into the surrounding air
- Reduces scattering loss at the surface of the core
- Protects the fiber from absorbing surface contaminants
- Adds mechanical strength

For extra protection, the cladding is enclosed in an additional layer called the coating or buffer. The coating or buffer is a layer of material used to protect an optical fiber from physical damage. The material used for a buffer is a type of plastic. The buffer is elastic in nature and prevents abrasions. The buffer also prevents the optical fiber from scattering losses caused by microbends. Microbends occur when an optical fiber is placed on a rough and distorted surface. Microbends are discussed later in this chapter.

Q19. List the three parts of an optical fiber.

Q20. Which fiber material, core or cladding, has a higher index of refraction?

PROPAGATION OF LIGHT ALONG A FIBER

The concept of light propagation, the transmission of light along an optical fiber, can be described by two theories. According to the first theory, light is described as a simple ray. This theory is the ray theory, or geometrical optics, approach. The advantage of the ray approach is that you get a clearer picture of the propagation of light along a fiber. The ray theory is used to approximate the light acceptance and guiding properties of optical fibers. According to the second theory, light is described as an electromagnetic wave. This theory is the mode theory, or wave representation, approach. The mode theory describes the behavior of light within an optical fiber. The mode theory is useful in describing the optical fiber properties of absorption, attenuation, and dispersion. These fiber properties are discussed later in this chapter.

Q21. Light transmission along an optical fiber is described by two theories. Which theory is used to approximate the light acceptance and guiding properties of an optical fiber?

Ray Theory

Two types of rays can propagate along an optical fiber. The first type is called meridional rays. Meridional rays are rays that pass through the axis of the optical fiber. Meridional rays are used to illustrate the basic transmission properties of optical fibers.

The second type is called skew rays. Skew rays are rays that travel through an optical fiber without passing through its axis.

MERIDIONAL RAYS.—Meridional rays can be classified as bound or unbound rays. Bound rays remain in the core and propagate along the axis of the fiber. Bound rays propagate through the fiber by total internal reflection. Unbound rays are refracted out of the fiber core. Figure 2-11 shows a possible path taken by bound and unbound rays in a step-index fiber. The core of the step-index fiber has an index of refraction n_1 . The cladding of a step-index has an index of refraction n_2 that is lower than n_1 . Figure 2-11 assumes the core-cladding interface is perfect. However, imperfections at the core-cladding interface will cause part of the bound rays to be refracted out of the core into the cladding. The light rays refracted into the cladding will eventually escape from the fiber. In general, meridional rays follow the laws of reflection and refraction.

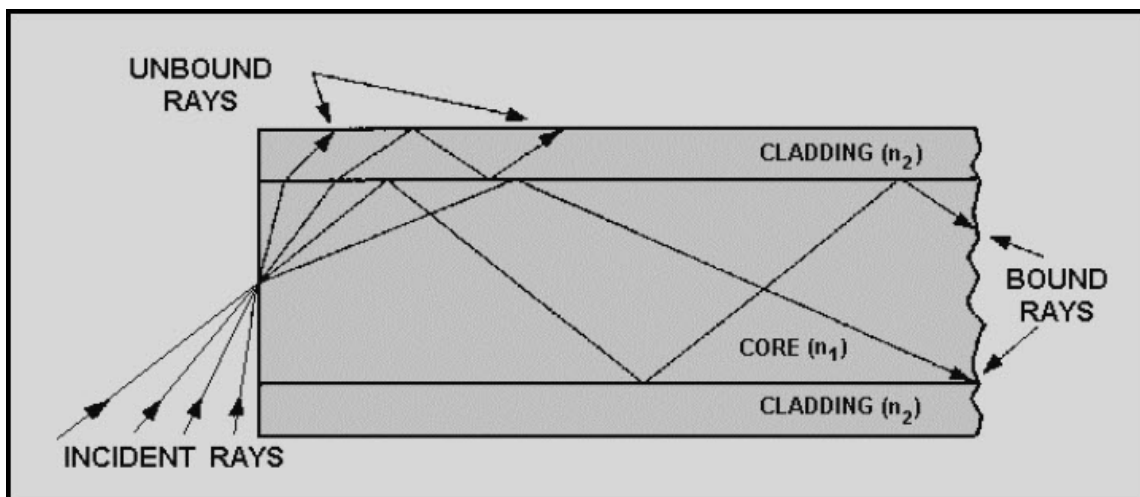

Figure 2-11. - Bound and unbound rays in a step-index fiber

It is known that bound rays propagate in fibers due to total internal reflection, but how do these light rays enter the fiber? Rays that enter the fiber must intersect the core-cladding interface at an angle greater than the critical angle (θ_c). Only those rays that enter the fiber and strike the interface at these angles will propagate along the fiber.

How a light ray is launched into a fiber is shown in figure 2-12. The incident ray I_1 enters the fiber at the angle θ_a . I_1 is refracted upon entering the fiber and is transmitted to the core-cladding interface. The ray then strikes the core-cladding interface at the critical angle (θ_c). I_1 is totally reflected back into the core and continues to propagate along the fiber. The incident ray I_2 enters the fiber at an angle greater than θ_a . Again, I_2 is refracted upon entering the fiber and is transmitted to the core-cladding interface. I_2 strikes the core-cladding interface at an angle less than the critical angle (θ_c). I_2 is refracted into the cladding and is eventually lost. The light ray incident on the fiber core must be within the acceptance cone defined by the angle θ_a shown in figure 2-13. Angle θ_a is defined as the acceptance angle. The acceptance angle (θ_a) is the maximum angle to the

axis of the fiber that light entering the fiber is propagated. The value of the angle of acceptance (θ_a) depends on fiber properties and transmission conditions.

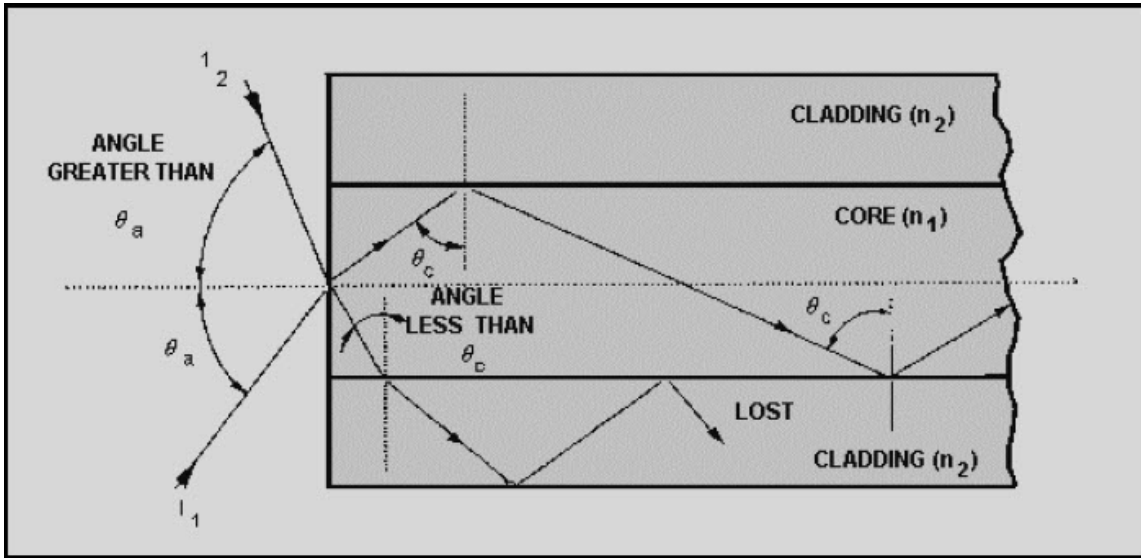

Figure 2-12. - How a light ray enters an optical fiber

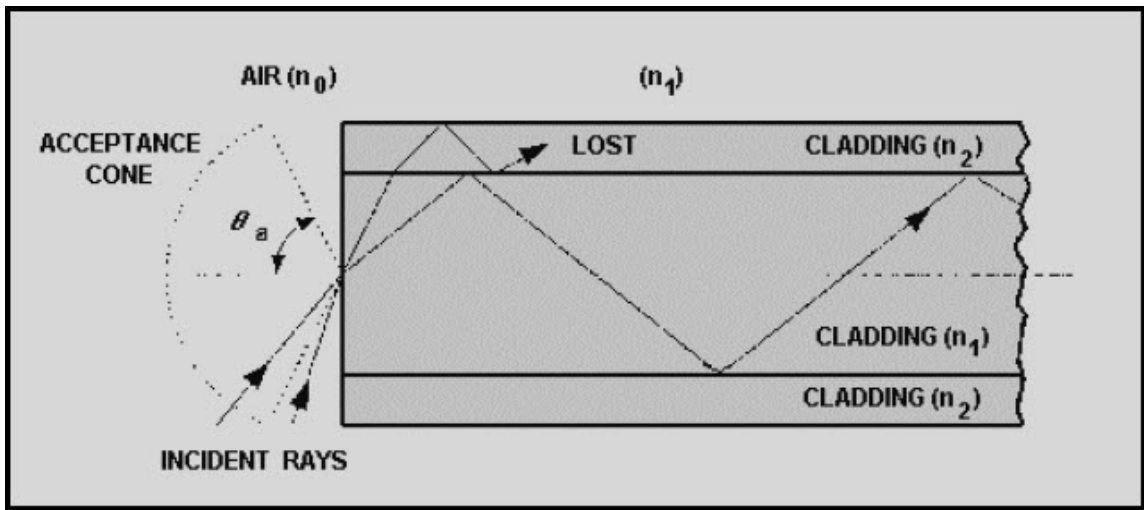

Figure 2-12 Fiber acceptance angle

The acceptance angle is related to the refractive indices of the core, cladding, and medium surrounding the fiber. This relationship is called the numerical aperture of the fiber. The numerical aperture (NA) is a measurement of the ability of an optical fiber to capture light. The NA is also used to define the acceptance cone of an optical fiber.

Figure 2-13 illustrates the relationship between the acceptance angle and the refractive indices. The index of refraction of the fiber core is n_1 . The index of refraction of the fiber cladding is n_2 . The index of refraction of the surrounding medium is n_0 . By using Snell's law and basic trigonometric relationships, the NA of the fiber is given by:

$$NA = n_0 \times \sin \Theta_a = (n_1^2 - n_2^2)^{\frac{1}{2}}$$

Since the medium next to the fiber at the launching point is normally air, n_0 is equal to 1.00. The NA is then simply equal to $\sin \Theta_a$. The NA is a convenient way to measure the light-gathering ability of an optical fiber. It is used to measure source-to-fiber power-coupling efficiencies. A high NA indicates a high source-to-fiber coupling efficiency. Source-to-fiber coupling efficiency is described in chapter 6. Typical values of NA range from 0.20 to 0.29 for glass fibers. Plastic fibers generally have a higher NA. An NA for plastic fibers can be higher than 0.50.

In addition, the NA is commonly used to specify multimode fibers. However, for small core diameters, such as in single mode fibers, the ray theory breaks down. Ray theory describes only the direction a plane wave takes in a fiber. Ray theory eliminates any properties of the plane wave that interfere with the transmission of light along a fiber. In reality, plane waves interfere with each other. Therefore, only certain types of rays are able to propagate in an optical fiber. Optical fibers can support only a specific number of guided modes. In small core fibers, the number of modes supported is one or only a few modes. Mode theory is used to describe the types of plane waves able to propagate along an optical fiber.

SKEW RAYS.—A possible path of propagation of skew rays is shown in figure 2-14. Figure 2-14, view A, provides an angled view and view B provides a front view. Skew rays propagate without passing through the center axis of the fiber. The acceptance angle for skew rays is larger than the acceptance angle of meridional rays. This condition explains why skew rays outnumber meridional rays. Skew rays are often used in the calculation of light acceptance in an optical fiber. The addition of skew rays increases the amount of light capacity of a fiber. In large NA fibers, the increase may be significant.

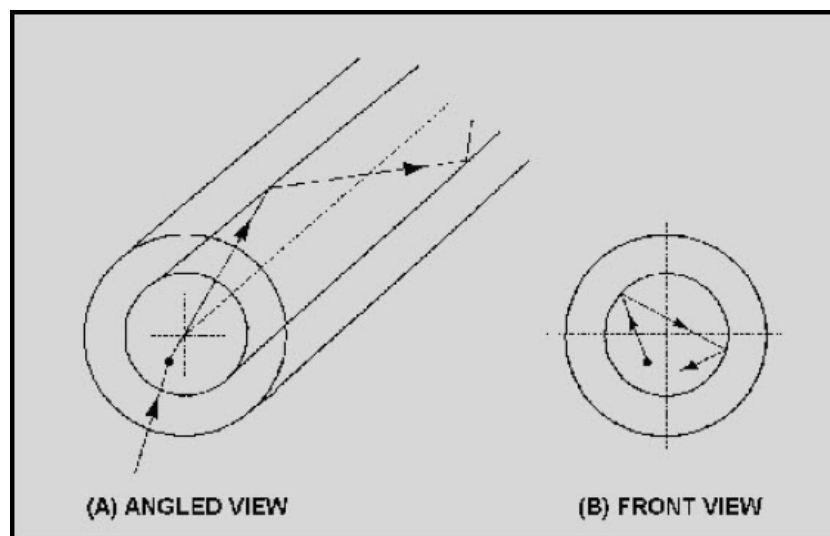

Figure 2-14. - Skew ray propagation: A. Angled view; B. Front view

The addition of skew rays also increases the amount of loss in a fiber. Skew rays tend to propagate near the edge of the fiber core. A large portion of the number of skew rays that are trapped in the fiber core are considered to be leaky rays. Leaky rays are predicted to be totally reflected at the core-cladding boundary. However, these rays are partially refracted because of the curved nature of the fiber boundary. Mode theory is also used to describe this type of leaky ray loss.

Q22. Meridional rays are classified as either bound or unbound rays. Bound rays propagate through the fiber according to what property?

Q23. A light ray incident on the optical fiber core is propagated along the fiber. Is the angle of incidence of the light ray entering the fiber larger or smaller than the acceptance angle (θ_a)

Q24. What fiber property does numerical aperture (NA) measure?

Q25. Skew rays and meridional rays define different acceptance angles. Which acceptance angle is larger, the skew ray angle or the meridional ray angle?

Mode Theory

The mode theory, along with the ray theory, is used to describe the propagation of light along an optical fiber. The mode theory is used to describe the properties of light that ray theory is unable to explain. The mode theory uses electromagnetic wave behavior to describe the propagation of light along a fiber. A set of guided electromagnetic waves is called the modes of the fiber.

Q26. The mode theory uses electromagnetic wave behavior to describe the propagation of the light along the fiber. What is a set of guided electromagnetic waves called?

PLANE WAVES.—The mode theory suggests that a light wave can be represented as a plane wave. A plane wave is described by its direction, amplitude, and wavelength of propagation. A plane wave is a wave whose surfaces of constant phase are infinite parallel planes normal to the direction of propagation. The planes having the same phase are called the wave fronts. The wavelength (λ) of the plane wave is given by:

$$\text{wavelength } (\lambda) = \frac{c}{fn}$$

where c is the speed of light in a vacuum, f is the frequency of the light, and n is the index of refraction of the plane-wave medium.

Figure 2-15 shows the direction and wave fronts of plane-wave propagation. Plane waves, or wave fronts, propagate along the fiber similar to light rays. However, not all wave fronts incident on the fiber at angles less than or equal to the critical angle of light acceptance propagate along the fiber. Wave fronts may undergo a change in phase that prevents the successful transfer of light along the fiber.

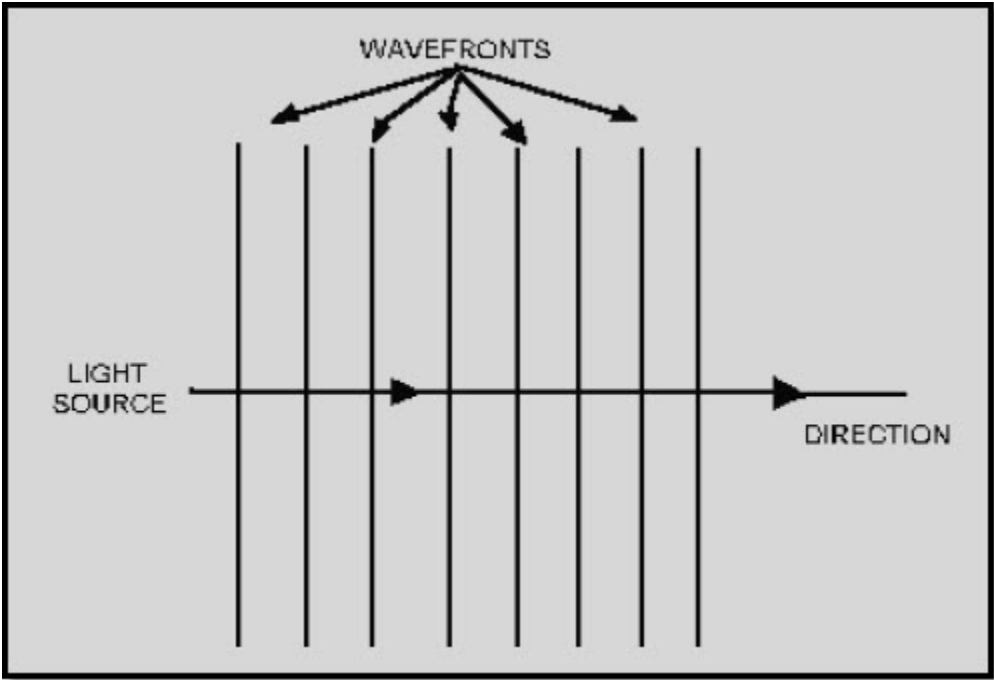

Figure 2-15. - Plane-wave propagation

Wave fronts are required to remain in phase for light to be transmitted along the fiber. Consider the wave front incident on the core of an optical fiber as shown in figure 2-15. Only those wave fronts incident on the fiber at angles less than or equal to the critical angle may propagate along the fiber. The wave front undergoes a gradual phase change as it travels down the fiber. Phase changes also occur when the wave front is reflected. The wave front must remain in phase after the wave front transverses the fiber twice and is reflected twice. The distance transversed is shown between point A and point B on figure 2-16. The reflected waves at point A and point B are in phase if the total amount of phase collected is an integer multiple of 2π radian. If propagating wave fronts are not in phase, they eventually disappear. Wave fronts disappear because of destructive

interference. The wave fronts that are in phase interfere with the wave fronts that are out of phase. This interference is the reason why only a finite number of modes can propagate along the fiber.

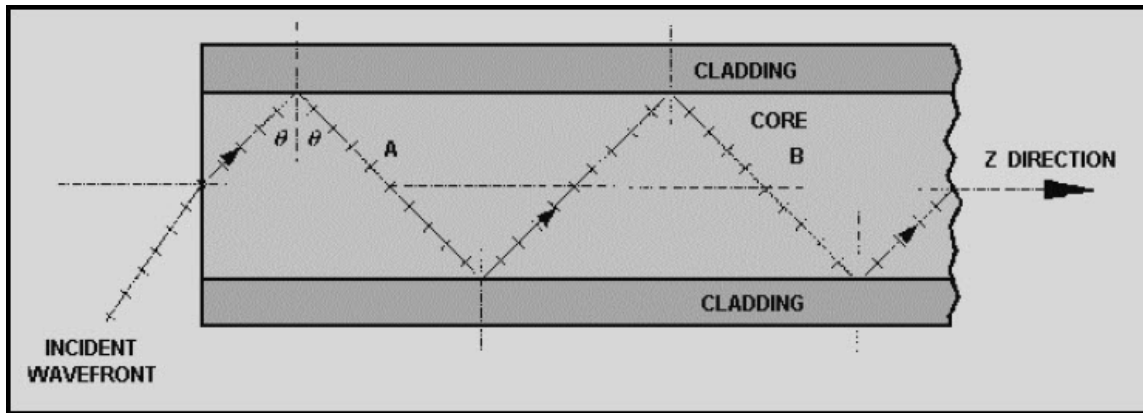

Figure 2-16. - Wave front propagation along an optical fiber

The plane waves repeat as they travel along the fiber axis. The direction the plane wave's travel is assumed to be the z direction as shown in figure 2-16. The plane waves repeat at a distance equal to $\lambda/\sin \theta$. Plane waves also repeat at a periodic frequency $\beta = 2\pi \sin \theta/\lambda$. The quantity β is defined as the propagation constant along the fiber axis. As the wavelength (λ) changes, the value of the propagation constant must also change. For a given mode, a change in wavelength can prevent the mode from propagating along the fiber. The mode is no longer bound to the fiber. The mode is said to be cut off. Modes that are bound at one wavelength may not exist at longer wavelengths. The wavelength at which a mode ceases to be bound is called the cutoff wavelength for that mode. However, an optical fiber is always able to propagate at least one mode. This mode is referred to as the fundamental mode of the fiber. The fundamental mode can never be cut off. The wavelength that prevents the next higher mode from propagating is called the cutoff wavelength of the fiber. An optical fiber that operates above the cutoff wavelength (at a longer wavelength) is called a single mode fiber. An optical fiber that operates below the cutoff wavelength is called a multimode fiber. Single mode and multimode optical fibers are discussed later in this chapter.

In a fiber, the propagation constant of a plane wave is a function of the wave's wavelength and mode. The change in the propagation constant for different waves is called dispersion. The change in the propagation constant for different wavelengths is called chromatic dispersion. The change in propagation constant for different modes is called modal dispersion. These dispersions cause the light pulse to spread as it goes down the fiber, see figure 2-17. Some dispersion occurs in all types of fibers. Dispersion is discussed later in this chapter.

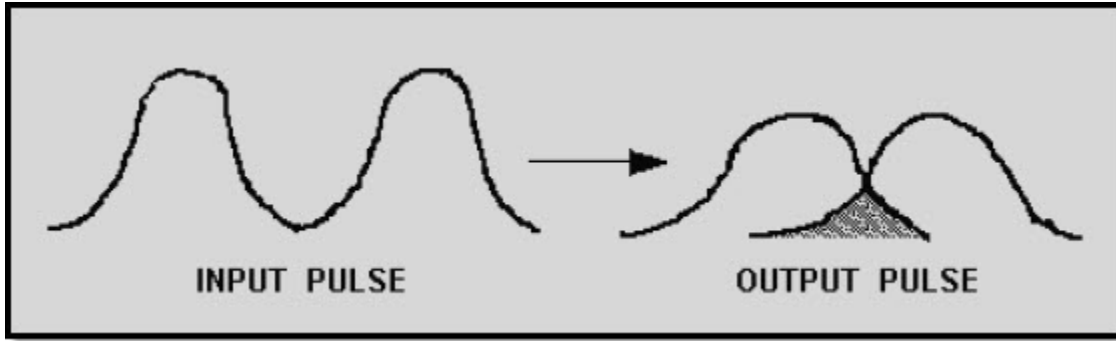

Figure 2-17. - The spreading of a light pulse

MODES.—A set of guided electromagnetic waves is called the modes of an optical fiber. Maxwell's equations describe electromagnetic waves or modes as having two components. The two components are the electric field, $E(x, y, z)$, and the magnetic field, $H(x, y, z)$. The electric field, E , and the magnetic field, H , are at right angles to each other. Modes traveling in an optical fiber are said to be transverse. The transverse modes, shown in figure 2-18, propagate along the axis of the fiber. The mode field patterns shown in figure 2-18 are said to be transverse electric (TE). In TE modes, the electric field is perpendicular to the direction of propagation. The magnetic field is in the direction of propagation. Another type of transverse mode is the transverse magnetic (TM) mode. TM modes are opposite to TE modes. In TM modes, the magnetic field is perpendicular to the direction of propagation. The electric field is in the direction of propagation. Figure 2-18 shows only TE modes.

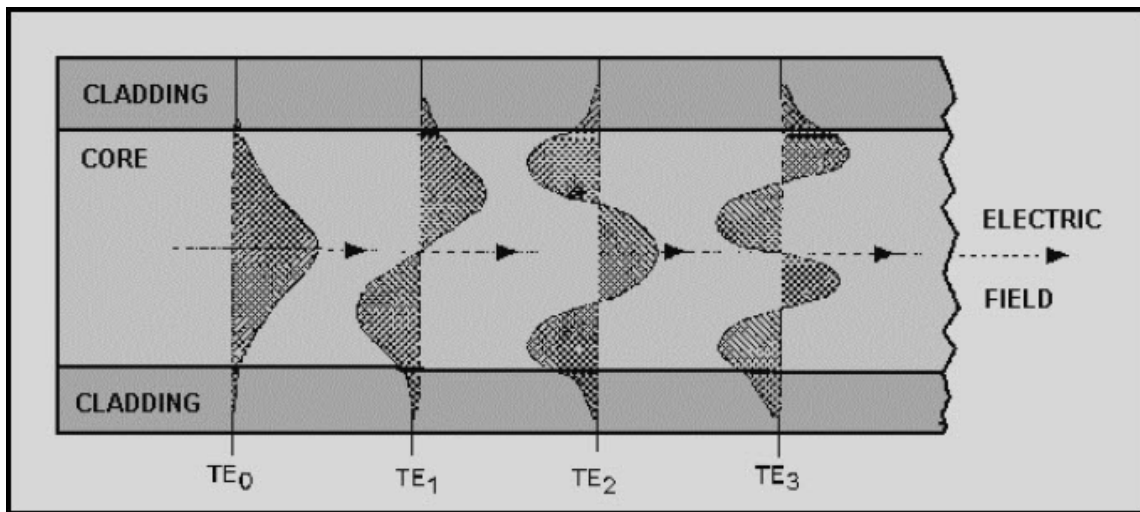

Figure 2-18. - Transverse electric (TE) mode field patterns

The TE mode field patterns shown in figure 2-18 indicate the order of each mode. The order of each mode is indicated by the number of field maxima within the core of the fiber. For example, TE_0 has one field maxima. The electric field is a maximum at the center of the waveguide and decays toward the core cladding boundary. TE_0 is considered the fundamental mode or the lowest order standing wave. As the number of field maxima

increases, the order of the mode is higher. Generally, modes with more than a few (5-10) field maxima are referred to as high-order modes.

The order of the mode is also determined by the angle the wave front makes with the axis of the fiber. Figure 2-19 illustrates light rays as they travel down the fiber. These light rays indicate the direction of the wave fronts. High-order modes cross the axis of the fiber at steeper angles. Low-order and high-order modes are shown in figure 2-19.

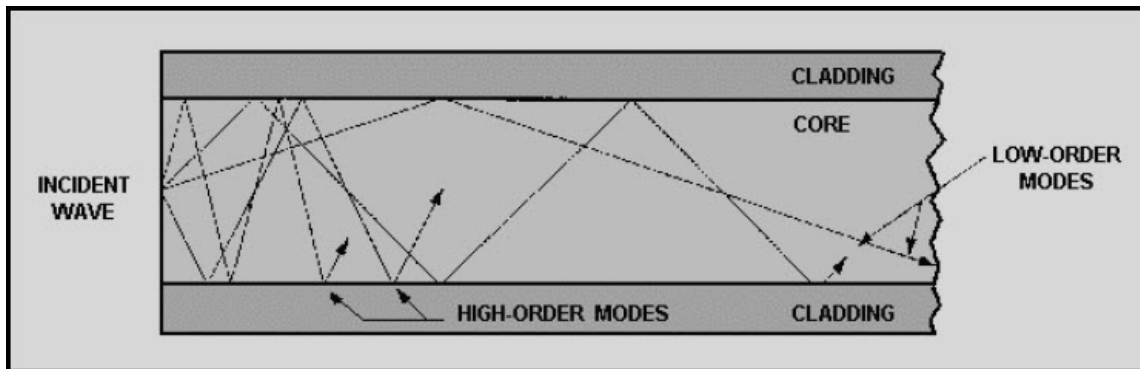

Figure 2-19. - Low-order and high-order modes

Before we progress, let us refer back to figure 2-18. Notice that the modes are not confined to the core of the fiber. The modes extend partially into the cladding material. Low-order modes penetrate the cladding only slightly. In low-order modes, the electric and magnetic fields are concentrated near the center of the fiber. Low-order modes take parallel or modestly transverse paths. However, high-order modes penetrate further into the cladding material and take considerably more transverse paths. In high-order modes, the electrical and magnetic fields are distributed more toward the outer edges of the fiber.

This penetration of low-order and high-order modes into the cladding region indicates that some portion is refracted out of the core. The refracted modes may become trapped in the cladding due to the dimension of the cladding region. The modes trapped in the cladding region are called cladding modes. As the core and the cladding modes travel along the fiber, mode coupling occurs. Mode coupling is the exchange of power between two modes. Mode coupling to the cladding results in the loss of power from the core modes.

In addition to bound and refracted modes, there are leaky modes. Leaky modes are similar to leaky rays. Leaky modes lose power as they propagate along the fiber. For a mode to remain within the core, the mode must meet certain boundary conditions. A mode remains bound if the propagation constant β meets the following boundary condition:

$$\frac{2\pi n_2}{\lambda} < \beta < \frac{2\pi n_1}{\lambda}$$

where n_1 and n_2 are the index of refraction for the core and the cladding, respectively. When the propagation constant becomes smaller than $2\pi n_2/\lambda$, power leaks out of the core and into the cladding. Generally, modes leaked into the cladding are lost in a few centimeters. However, leaky modes can carry a large amount of power in short fibers.

NORMALIZED FREQUENCY.—Electromagnetic waves bound to an optical fiber are described by the fiber's normalized frequency. The normalized frequency determines how many modes a fiber can support. Normalized frequency is a dimensionless quantity. Normalized frequency is also related to the fiber's cutoff wavelength. Normalized frequency (V) is defined as:

$$V = \frac{2\pi a}{\lambda} (n_1^2 - n_2^2)^{\frac{1}{2}}$$

where n_1 is the core index of refraction, n_2 is the cladding index of refraction, a is the core diameter, and λ is the wavelength of light in air.

The number of modes that can exist in a fiber is a function of V . As the value of V increases, the number of modes supported by the fiber increases. Optical fibers, single mode and multimode, can support a different number of modes. The number of modes supported by single mode and multimode fiber types is discussed later in this chapter.

Q27. A light wave can be represented as a plane wave. What three properties of light propagation describe a plane wave?

Q28. A wave front undergoes a phase change as it travels along the fiber. If the wave front transverses the fiber twice and is reflected twice and the total phase change is equal to $1/2\pi$, will the wave front disappear? If yes, why?

Q29. Modes that are bound at one wavelength may not exist at longer wavelengths. What is the wavelength at which a mode ceases to be bound called?

Q30. What type of optical fiber operates below the cutoff wavelength?

Q31. Low-order and high-order modes propagate along an optical fiber. How are modes determined to be low-order or high-order modes?

Q32. As the core and cladding modes travel along the fiber, mode coupling occurs. What is mode coupling?

Q33. The fiber's normalized frequency (V) determines how many modes a fiber can support. As the value of V increases, will the number of modes supported by the fiber increase or decrease?

OPTICAL FIBER TYPES

Optical fibers are characterized by their structure and by their properties of transmission. Basically, optical fibers are classified into two types. The first type is single mode fibers. The second type is multimode fibers. As each name implies, optical fibers are classified by the number of modes that propagate along the fiber. As previously explained, the structure of the fiber can permit or restrict modes from propagating in a fiber. The basic structural difference is the core size. Single mode fibers are manufactured with the same materials as multimode fibers. Single mode fibers are also manufactured by following the same fabrication process as multimode fibers.

Single Mode Fibers

The core size of single mode fibers is small. The core size (diameter) is typically around 8 to 10 micrometers (μm). A fiber core of this size allows only the fundamental or lowest order mode to propagate around a 1300 nanometer (nm) wavelength. Single mode fibers propagate only one mode, because the core size approaches the operational wavelength (λ). This is achieved by using a LASER as a light source. The value of the normalized frequency parameter (V) relates core size with mode propagation. In single mode fibers, V is less than or equal to 2.405. When $V > 2.405$, single mode fibers propagate the fundamental mode down the fiber core, while high-order modes are lost in the cladding. For low V values (< 1.0), most of the power is propagated in the cladding material. Power transmitted by the cladding is easily lost at fiber bends. The value of V should remain near the 2.405 level.

Single mode fibers have a lower signal loss and a higher information capacity (bandwidth) than multimode fibers. Single mode fibers are capable of transferring higher amounts of data due to low fiber dispersion. Basically, dispersion is the spreading of light as light propagates along a fiber. Dispersion mechanisms in single mode fibers are discussed in more detail later in this chapter. Signal loss depends on the operational wavelength (λ). In single mode fibers, the wavelength can increase or decrease the losses

caused by fiber bending. Single mode fibers operating at wavelengths larger than the cutoff wavelength lose more power at fiber bends. They lose power because light radiates into the cladding, which is lost at fiber bends. In general, single mode fibers are considered to be low-loss fibers, which increase system bandwidth and length.

Q34. The value of the normalized frequency parameter (V) relates the core size with mode propagation. When single mode fibers propagate only the fundamental mode, what is the value of V ?

Multimode Fibers

As their name implies, multimode fibers propagate more than one mode. Multimode fibers can propagate over 100 modes. The number of modes propagated depends on the core size and numerical aperture (NA). As the core size and NA increase, the number of modes increases. Typical values of fiber core size and NA are 50 to 100 μm and 0.20 to 0.29, respectively.

A large core size and a higher NA have several advantages. Light is launched into a multimode fiber with more ease. The higher NA and the larger core size make it easier to make fiber connections. During fiber splicing, core-to-core alignment becomes less critical. Another advantage is that multimode fibers permit the use of light-emitting diodes (LEDs). Single mode fibers typically must use LASER diodes. LEDs are cheaper, less complex, and last longer. LEDs are preferred for most applications.

Multi-mode fibers are described by their core and cladding diameters. Thus, 62.5/125 μm multi-mode fiber has a core size of 62.5 micrometers (μm) and a cladding diameter of 125 μm . The transition between the core and cladding can be sharp, which is called a step-index profile, or a gradual transition, which is called a graded-index profile. The two types have different dispersion characteristics and thus different effective propagation distance. Multi-mode fibers may be constructed with either graded or step-index profile.

In addition, multi-mode fibers are described using a system of classification determined by the ISO 11801 standard — OM1, OM2, OM3 — which is based on the modal bandwidth of the multi-mode fiber & OM4. OM4 cable will support 125m links at 40 and 100 Gbit/s. The letters "OM" stand for *optical multi-mode*.

For many years 62.5/125 μm (OM1) and conventional 50/125 μm multi-mode fiber (OM2) were widely deployed in premises applications. These fibers easily support applications ranging from Ethernet (10 Mbit/s) to Gigabit Ethernet (1 Gbit/s) and, because of their relatively large core size, were ideal for use with LED transmitters. Newer deployments often use laser-optimized 50/125 μm multi-mode fiber (OM3). Fibers that meet this designation provide sufficient bandwidth to support 10 Gigabit Ethernet up to 300 meters. Optical fiber manufacturers have greatly refined their manufacturing process since that standard was issued and cables can be made that

support 10 GbE up to 550 meters (OM4). Laser Optimized Multi-mode Fiber (LOMMF) is designed for use with 850 nm Vertical-Cavity Surface Emitting Laser (VCSEL).

The migration to LOMMF/OM3 has occurred as users upgrade to higher speed networks. LEDs have a maximum modulation rate of 622 Mbit/s because they cannot be turned on/off fast enough to support higher bandwidth applications. VCSELs are capable of modulation over 10 Gbit/s and are used in many high speed networks.

Cables can sometimes be distinguished by jacket color: for 62.5/125 μm (OM1) and 50/125 μm (OM2), orange jackets are recommended, while Aqua is recommended for 50/125 μm "Laser Optimized" OM3 and OM4 fiber.

VCSEL power profiles, along with variations in fiber uniformity, can cause modal dispersion which is measured by differential modal delay (DMD). Modal dispersion is an effect caused by the different speeds of the individual modes in a light pulse. The net effect causes the light pulse to separate or spread over distance, making it difficult for receivers to identify the individual 1's and 0's (this is called inter-symbol interference). The greater the length, the greater the modal dispersion. To combat modal dispersion, LOMMF is manufactured in a way that eliminates variations in the fiber which could affect the speed that a light pulse can travel. The refractive index profile is enhanced for VCSEL transmission and to prevent pulse spreading. As a result the fibers maintain signal integrity over longer distances, thereby maximizing the bandwidth.

2 Transmission Standards	3 100 Mb Ethernet	4 1 Gb (1000 Mb) Ethernet	10 Gb Ethernet	40 Gb Ethernet	100 Gb Ethernet
OM1 (62.5/125)	up to 2000 meters (FX)	275 meters (SX)	33 meters (SR)	Not supported	Not supported
OM2 (50/125)	up to 2000 meters (FX)	550 meters (SX)	82 meters (SR)	Not supported	Not supported
OM3 (50/125)	up to 2000 meters (FX)	800 meters (SX)	300 meters (SR)	100 meters	100 meters
OM4 (50/125)	up to 2000 meters (FX)	880 meters (SX)	300 meters (SR)	125 meters	125 meters

Q35. The number of modes propagated in a multimode fiber depends on core size and numerical aperture (NA). If the core size and the NA decrease, will the number of modes propagated increase or decrease?

Q36. What are the different classifications of multimode fiber?

Plastic Optical Fiber (POF)

POF is an optical fiber which is made out of plastic, traditionally from PMMA (poly methyl meth acrylate), a transparent shatter resistant alternative to silica glass (sometimes referred to as acrylic glass). PMMA is an economical alternative to silica

glass when extreme strength is not necessary. It is often preferred because of its ease in handling and processing and low cost. The core size of POF is in some cases 100 times larger than glass fiber. In larger diameter fiber, up to 96% of the cross section is the core that allows the transmission of light. POF is often called the “consumer” optical fiber because the fiber and the associated components are all relatively inexpensive. Common applications include sensing or where low speed and short distances (less than 100 meters) make POF desired. Digital home appliances, home networks, industrial networks, and automotive networks are also common applications.

Hard Clad Silica (HCS)

HCS is a fiber with a core of silica glass (200 μm) and an optical cladding made of special plastic (230 μm). HCS fibers are limited to distances up to 2 kilometers and are used in local networks in buildings or small industries. Comparing both bandwidth and distances, HCS fibers rank between POF and multimode & single mode fibers.

Plastic Clad Silica (PCS)

PCS fiber is an optical fiber that has a silica based core and a plastic cladding. PCS fibers in general have significantly lower performance characteristics, higher transmission losses, and lower bandwidths than all glass fibers. PCS is commonly used in industrial, medical, or component sensing applications where cores that are larger than standard fibers are more advantageous.

PROPERTIES OF OPTICAL FIBER TRANSMISSION

The principles behind the transfer of light along an optical fiber were discussed earlier in this chapter. You learned that propagation of light depended on the nature of light and the structure of the optical fiber. However, our discussion did not describe how optical fibers affect system performance. In this case, system performance deals with signal loss and bandwidth.

Signal loss and system bandwidth describe the amount of data transmitted over a specified length of fiber. Many optical fiber properties increase signal loss and reduce system bandwidth. The most important properties that affect system performance are fiber attenuation and dispersion.

Attenuation reduces the amount of optical power transmitted by the fiber. Attenuation controls the distance an optical signal (pulse) can travel as shown in figure 2-20. Once the power of an optical pulse is reduced to a point where the receiver is unable to detect the pulse, an error occurs. Attenuation is mainly a result of **light absorption, scattering, and bending losses**. Dispersion spreads the optical pulse as it travels along the fiber. This spreading of the signal pulse reduces the system bandwidth or the information-carrying capacity of the fiber. Dispersion limits how fast information is transferred as shown in figure 2-20. An error occurs when the receiver is unable to distinguish between input pulses caused by the spreading of each pulse. The effects of

attenuation and dispersion increase as the pulse travels the length of the fiber as shown in figure 2-21.

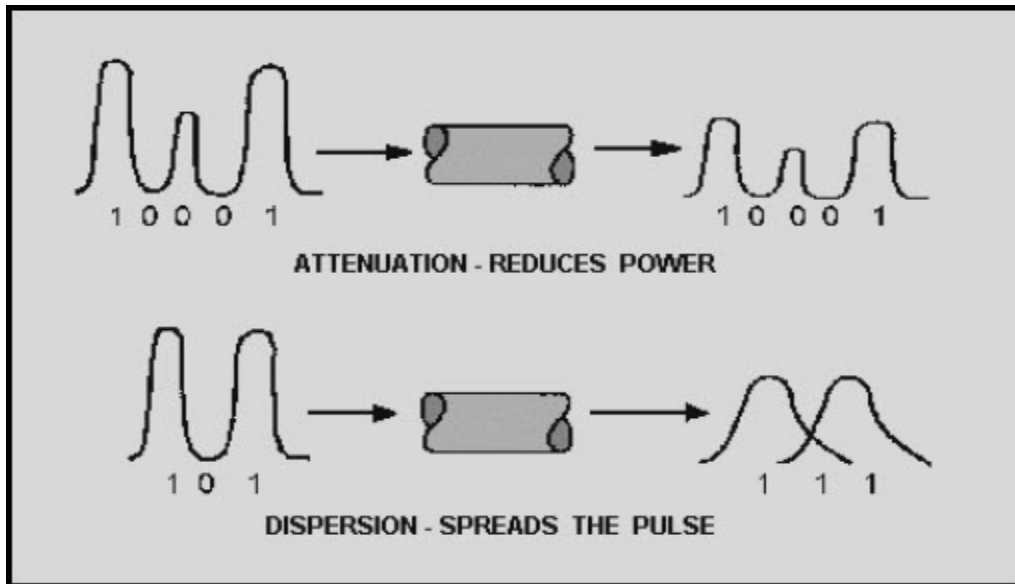

Figure 2-20. - Fiber transmission properties

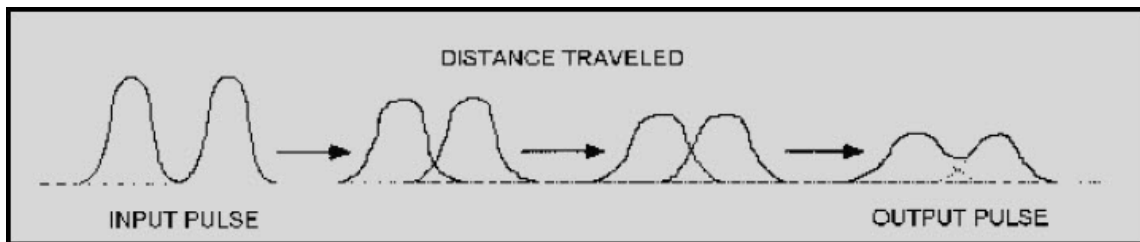

Figure 2-21. -Pulse spreading and power loss along an optical fiber

In addition to fiber attenuation and dispersion, other optical fiber properties affect system performance. Fiber properties, such as modal noise, pulse broadening, and polarization, can reduce system performance. Modal noise, pulse broadening, and polarization are too complex to discuss as introductory level material. However, you should be aware that attenuation and dispersion are not the only fiber properties that affect performance.

Q37. Attenuation is mainly a result of what three properties?

Attenuation

Attenuation in an optical fiber is caused by absorption, scattering, and bending losses. Attenuation is the loss of optical power as light travels along the fiber. Signal attenuation is defined as the ratio of optical input power (P_i) to the optical output power

(P_o). Optical input power is the power injected into the fiber from an optical source. Optical output power is the power received at the fiber end or optical detector. The following equation defines signal attenuation as a unit of length:

$$\text{attenuation} = \left(\frac{10}{L} \right) \log_{10} \left(\frac{P_i}{P_o} \right)$$

Signal attenuation is a log relationship. Length (L) is expressed in kilometers. Therefore, the unit of attenuation is decibels/kilometer (dB/km).

As previously stated, attenuation is caused by absorption, scattering, and bending losses. Each mechanism of loss is influenced by fiber-material properties and fiber structure. However, loss is also present at fiber connections. Fiber connector, splice, and coupler losses are discussed in chapter 4. The present discussion remains relative to optical fiber attenuation properties.

Q38. Define attenuation.

Absorption.

Absorption is a major cause of signal loss in an optical fiber. **Absorption** is defined as the portion of attenuation resulting from the conversion of optical power into another energy form, such as heat. Absorption in optical fibers is explained by three factors:

- Imperfections in the atomic structure of the fiber material
- The intrinsic or basic fiber-material properties
- The extrinsic (presence of impurities) fiber-material properties

Imperfections in the atomic structure induce absorption by the presence of missing molecules or oxygen defects. Absorption is also induced by the diffusion of hydrogen molecules into the glass fiber. Since intrinsic and extrinsic material properties are the main cause of absorption, they are discussed further.

Intrinsic Absorption.—Intrinsic absorption is caused by basic fiber-material properties. If an optical fiber were absolutely pure, with no imperfections or impurities, then all absorption would be intrinsic. Intrinsic absorption sets the minimal level of absorption. In fiber optics, silica (pure glass) fibers are used predominately. Silica fibers are used because of their low intrinsic material absorption at the wavelengths of operation.

In silica glass, the wavelengths of operation range from 700 nanometers (nm) to 1600 nm. Figure 2-22 shows the level of attenuation at the wavelengths of operation. This wavelength of operation is between two intrinsic absorption regions. The first region is the ultraviolet region (below 400-nm wavelength). The second region is the infrared region (above 2000-nm wavelength).

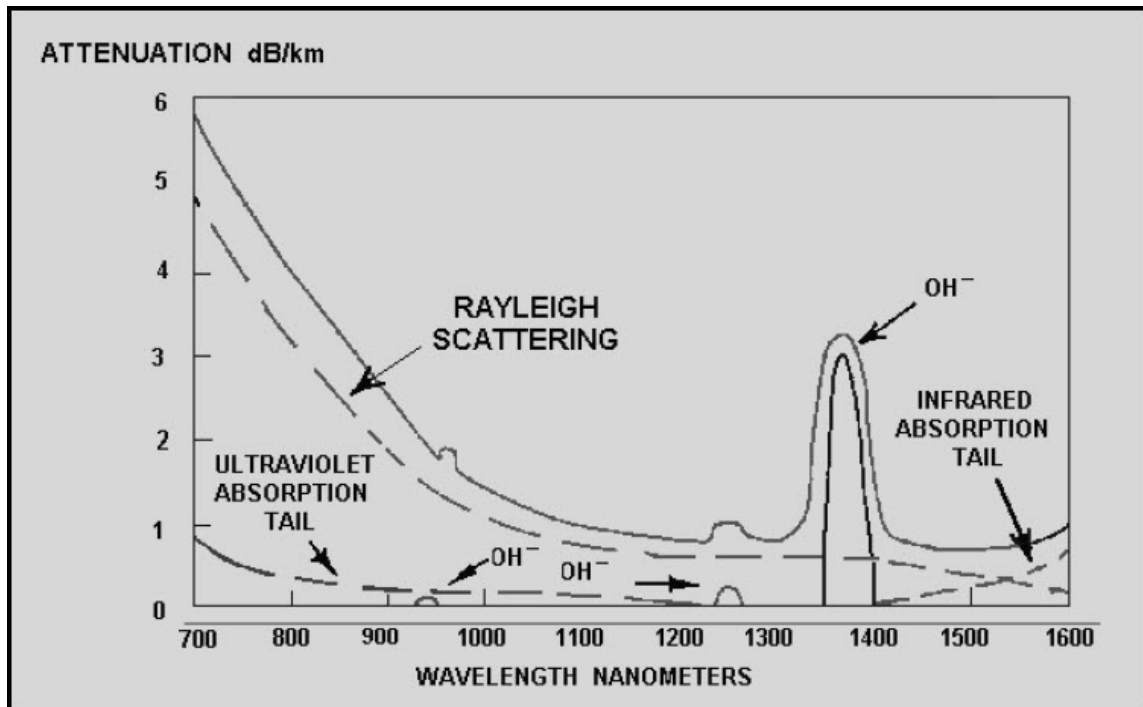

Figure 2-22. - Fiber losses.

Intrinsic absorption in the ultraviolet region is caused by electronic absorption bands. Basically, absorption occurs when a light particle (photon) interacts with an electron and excites it to a higher energy level. The tail of the ultraviolet absorption band is shown in figure 2-22.

The main cause of intrinsic absorption in the infrared region is the characteristic vibration frequency of atomic bonds. In silica glass, absorption is caused by the vibration of silicon-oxygen (Si-O) bonds. The interaction between the vibrating bond and the electromagnetic field of the optical signal causes intrinsic absorption. Light energy is transferred from the electromagnetic field to the bond.

Extrinsic Absorption.—Extrinsic absorption is caused by impurities introduced into the fiber material. Trace metal impurities, such as iron, nickel, and chromium, are introduced into the fiber during fabrication. **Extrinsic absorption** is caused by the electronic transition of these metal ions from one energy level to another.

Extrinsic absorption also occurs when hydroxyl ions (OH^-) are introduced into the fiber. Water in silica glass forms a silicon-hydroxyl (Si-OH) bond. This bond has a

fundamental absorption at 2700 nm. However, the harmonics or overtones of the fundamental absorption occur in the region of operation. These harmonics increase extrinsic absorption at 1383nm, 1250nm, and 950nm. Figure 2-22 shows the presence of the three OH⁻ harmonics. The level of the OH⁻ harmonic absorption is also indicated.

These absorption peaks define three regions or windows of preferred operation. The first window is centered at 850nm. The second window is centered at 1300nm. The third window is centered at 1550nm. Fiber optic systems operate at wavelengths defined by one of these windows.

The amount of water (OH⁻) impurities present in a fiber should be less than a few parts per billion. Fiber attenuation caused by extrinsic absorption is affected by the level of impurities (OH⁻) present in the fiber. If the amount of impurities in a fiber is reduced, then fiber attenuation is reduced.

Q39. What are the main causes of absorption in optical fiber?

Q40. Silica (pure glass) fibers are used because of their low intrinsic material absorption at the wavelengths of operation. This wavelength of operation is between two intrinsic absorption regions. What are these two regions called? What are the wavelengths of operation for these two regions?

Q41. Extrinsic (OH⁻) absorption peaks define three regions or windows of preferred operation. List the three windows of operation.

Scattering

Basically, scattering losses are caused by the interaction of light with density fluctuations within a fiber. Density changes are produced when optical fibers are manufactured. During manufacturing, regions of higher and lower molecular density areas, relative to the average density of the fiber, are created. Light traveling through the fiber interacts with the density areas as shown in figure 2-23. Light is then partially scattered in all directions.

In commercial fibers operating between 700nm and 1600nm wavelength, the main source of loss is called Rayleigh scattering. Rayleigh scattering is the main loss mechanism between the ultraviolet and infrared regions as shown in figure 2-22. Rayleigh scattering occurs when the size of the density fluctuation (fiber defect) is less than one-tenth of the operating wavelength of light. Loss caused by Rayleigh scattering is proportional to the fourth power of the wavelength ($1/\lambda^4$). As the wavelength increases, the loss caused by Rayleigh scattering decreases.

If the size of the defect is greater than one-tenth of the wavelength of light, the scattering mechanism is called Mie scattering. Mie scattering, caused by these large defects in the fiber core, scatters light out of the fiber core. However, in commercial fibers, the effects of Mie scattering are insignificant. Optical fibers are manufactured with very few large defects.

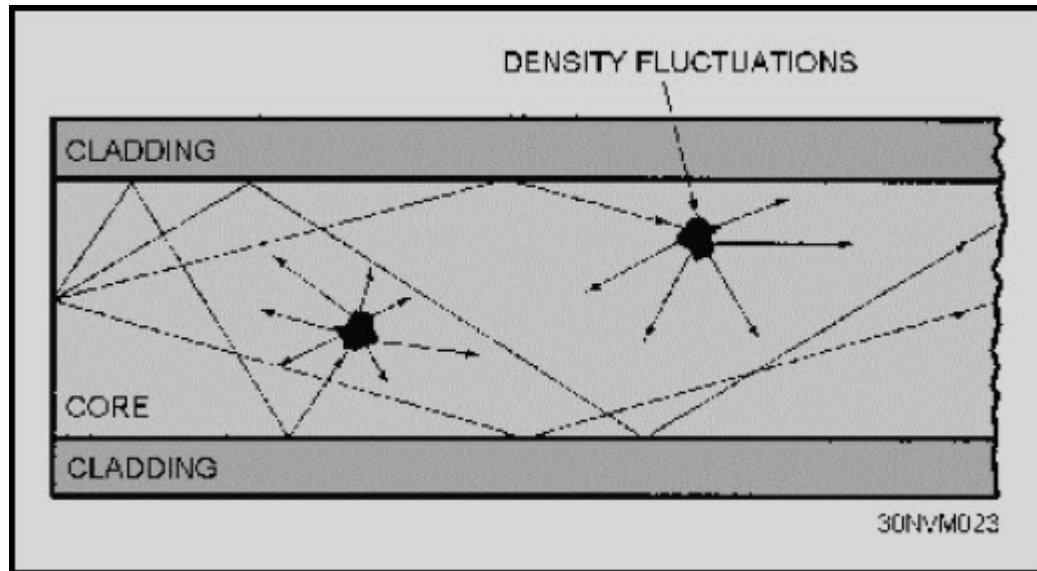

Figure 2-23. - Light scattering

Q42. What is the main loss mechanism between the ultraviolet and infrared absorption regions?

Q43. Scattering losses are caused by the interaction of light with density fluctuations within a fiber. What are the two scattering mechanisms called when the size of the density fluctuations is (a) greater than and (b) less than one-tenth of the operating wavelength?

Bending Loss

Bending the fiber also causes attenuation. Bending loss is classified according to the bend radius of curvature: microbend loss or macrobend loss. Microbends are small microscopic bends of the fiber axis that occur mainly when a fiber is cabled. Macrobends are bends having a large radius of curvature relative to the fiber diameter. Microbend and macrobend losses are very important loss mechanisms. Fiber loss caused by microbending can still occur even if the fiber is cabled correctly. During installation, if fibers are bent too sharply, macrobend losses will occur.

Microbend losses are caused by small discontinuities or imperfections in the fiber. Uneven coating applications and improper cabling procedures increase microbend loss.

External forces are also a source of microbends. An external force deforms the cabled jacket surrounding the fiber but causes only a small bend in the fiber. Microbends change the path that propagating modes take, as shown in figure 2-24. Microbend loss increases attenuation because low-order modes become coupled with high-order modes that are naturally lossy.

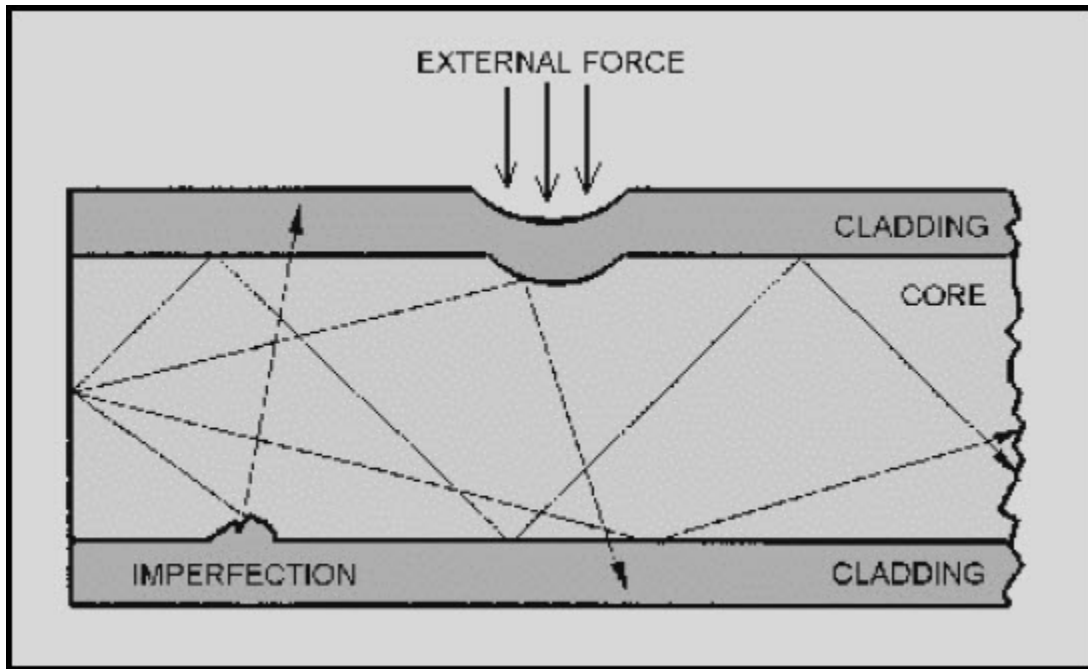

Figure 2-24. - Microbend loss

Macrobend losses are observed when a fiber bend's radius of curvature is large compared to the fiber diameter. These bends become a great source of loss when the radius of curvature is less than several centimeters. Light propagating at the inner side of the bend travels a shorter distance than that on the outer side. To maintain the phase of the light wave, the mode phase velocity must increase. When the fiber bend is less than some critical radius, the mode phase velocity must increase to a speed greater than the speed of light. However, it is impossible to exceed the speed of light. This condition causes some of the light within the fiber to be converted to high-order modes. These high-order modes are then lost or radiated out of the fiber.

Fiber sensitivity to bending losses can be reduced. If the refractive index of the core is increased, then fiber sensitivity decreases. Sensitivity also decreases as the diameter of the overall fiber increases. However, increases in the fiber core diameter increase fiber sensitivity. Fibers with larger core size propagate more modes. These additional modes tend to be more lossy.

Q44. Microbend loss is caused by microscopic bends of the fiber axis. List three sources of microbend loss.

Q45. How is fiber sensitivity to bending losses reduced?

DISPERSION

Is the spreading of a pulse of light as it travels down the length of an optical fiber. Dispersion limits the bandwidth or information carrying capacity of a fiber. The bit rate must be low enough to ensure that pulses do not overlap. A lower bit rate means that the pulses are farther apart and, therefore, that greater dispersion can be tolerated. There are five types of dispersion:

1. Modal dispersion
2. Material dispersion
3. Waveguide dispersion
4. Chromatic dispersion
5. Polarization mode dispersion

Modal Dispersion

Modal dispersion occurs only in multimode fibers. It is the result of light rays following different paths through the fiber core and consequently arrives at the fiber end at different times. The input light pulse is made up of a group of modes. As the modes propagate along the fiber, light energy distributed among the modes is delayed by different amounts. The pulse spreads because each mode propagates along the fiber at different speeds. Since modes travel in different directions, some modes travel longer distances. Modal dispersion occurs because each mode travels a different distance over the same time span, as shown in figure 2-25. The modes of a light pulse that enter the fiber at one time exit the fiber a different times. This condition causes the light pulse to spread. As the length of the fiber increases, modal dispersion increases.

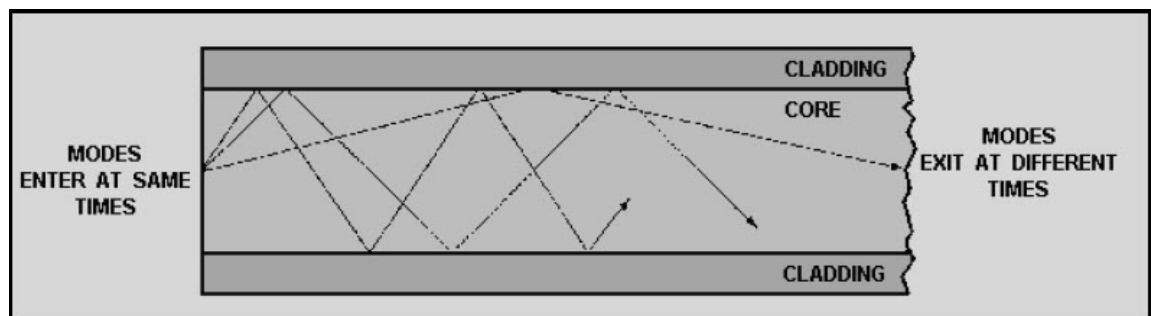

Figure 2-25. - Distance traveled by each mode over the same time span

Material Dispersion

Material dispersion occurs because different wavelengths (colors) also travel at different velocities through a fiber, even in the same mode. Remember, $n = c/v$ where “c”

is the speed of light in a vacuum and “v” is the speed of the same wavelength in a material. Here the index of refraction will change according to the wavelength. Material dispersion occurs because the spreading of a light pulse is dependent on the wavelengths' interaction with the refractive index of the fiber core. Different wavelengths travel at different speeds in the fiber material. Different wavelengths of a light pulse that enter a fiber at one time exit the fiber at different times. Material dispersion is a function of the source spectral width. The spectral width specifies the range of wavelengths that can propagate in the fiber. Material dispersion is less at longer wavelengths.

The amount of dispersion depends on two factors:

1. The range of wavelengths injected into the fiber. A source does not emit a single wavelength; it emits several. The range of wavelengths, expressed in nanometers, is the spectral width of the source. An LED can have a spectral width in the range of 35nm to well over 100nm. A Laser diodes spectral width is .1nm to 3nm.

2. Longer “reddish” wavelengths travel faster than shorter “bluish” wavelengths. An 860nm wavelength travels faster than an 840nm wavelength. At 1550nm, the situation is reversed. The shorter wavelength travels faster than longer ones: a 1560nm wavelength travels slower than a 1540nm wavelength. At some point a crossover must occur where the bluish and reddish wavelengths travel at the same speed. This point is called the zero dispersion point occurs at 1300nm.

Material dispersion is of greater concern in single-mode systems. A standard single-mode fiber has the lowest material dispersion at 1300nm and the lowest loss at 1550nm. Or, it has the highest information-carrying capacity at 1300nm and the longer transmission distance at 1550nm. Dispersion is about five times higher at 1550nm than at 1300nm, while attenuation is about 0.2 dB lower.

A dispersion-shifted fiber attempts to give the designer the best of both worlds, low loss and high bandwidth at the same optical wavelength. The zero-dispersion wavelength is shifted from the 1300nm region to 1550nm.

Zero dispersion-shifted (DS) fibers have the zero dispersion point shifted to 1550nm to coincide with the low attenuation operating point. Material dispersion is reduced to zero. DS fibers work well when a single channel data stream is transmitted through the fiber. The newer systems send more than one channel through the fiber. They may send channels or streams of data at 1546, 1548, 1550, and 1552nm. Here an effect called four-wave mixing robs the signals of power and increase noise in the system. Four-wave mixing occurs in fibers that have the zero dispersion point at or near the wavelengths being transmitted. This mixing can seriously limit the use of multiple wavelengths in DWDM applications and this will lower transmission speeds.

Adding a small amount of dispersion can suppress four-wave mixing. Nonzero-dispersion-shifted (NZ-DS) fibers overcome this problem by shifting the zero dispersion point not to 1550nm, but to a point nearby. NZ-DS fibers, because of their ability to

handle high data rates and multiple wavelengths, are widely used in communications applications, surpassing DS fibers.

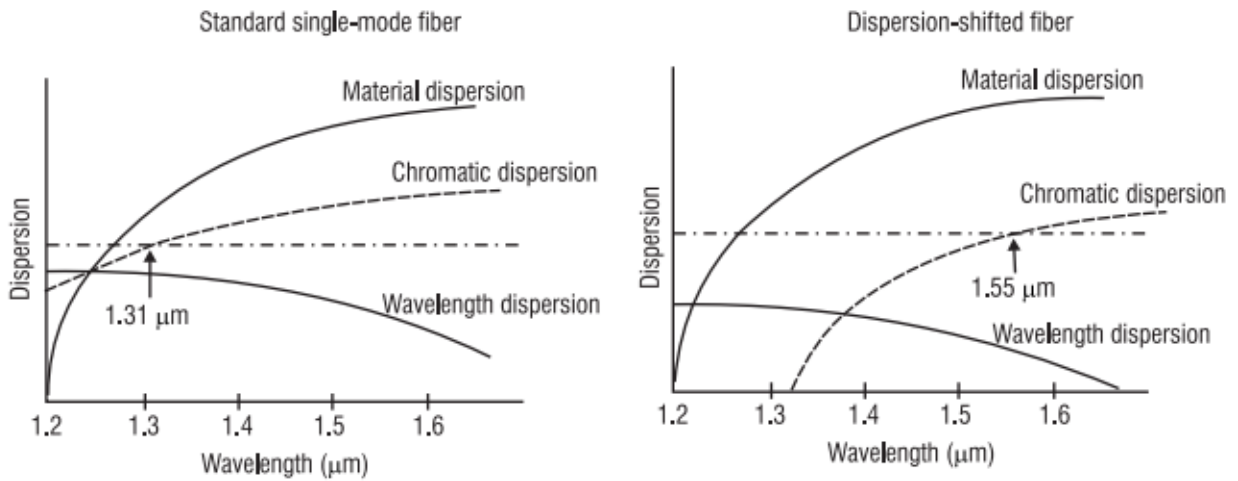

Waveguide Dispersion

Waveguide dispersion occurs because the mode propagation constant (β) is a function of the size of the fiber's core relative to the wavelength of operation. Waveguide dispersion is most significant in a single-mode fiber. The energy level travels at slightly different velocities in the core and cladding because of the slightly different refractive indices of the materials. Altering the internal structure of the fiber allows waveguide dispersion to be substantially changed, thus changing the specified overall dispersion of the fiber. About 80% of the light is propagated down the core with the remaining 20% traveling down the cladding.

To understand the physical origin of waveguide dispersion, we need to know that the light energy of a mode propagates partly in the core and partly in the cladding and that the effective index of a mode lies between the refractive indices of the cladding and the core. The actual value of the effective index between these two limits depends on the proportion of power that is contained in the cladding and the core. If most of the power is contained in the core, the effective index is closer to the core refractive index. If most of the power propagates in the cladding, the effective index is closer to the cladding refractive index.

The power distribution of a mode between the core and the cladding of a fiber is itself a function of the wavelength. More accurately, the longer the wavelength, the more power in the cladding. Thus, even in the absence of material dispersion, the refractive indices of the core and the cladding are independent of wavelength. If the wavelength changes, the power distribution changes.

Chromatic Dispersion (CD)

Chromatic Dispersion (CD) is the term given to the phenomenon by which different spectral components of a light pulse travel at different speeds. CD arises for two reasons. The first reason is that the refractive index of silica is frequency dependent. Thus different frequency components travel at different speeds in silica. This component of CD is called material Dispersion. The second reason is that although material dispersion is the principle component of chromatic dispersion for most fibers, there is a second component called Waveguide Dispersion.

Polarization Mode Dispersion (PMD)

Polarization mode dispersion (PMD) is a minor type of dispersion that only becomes significant in a system that has already minimized other forms of dispersion and that is operating at gigabit data rates. Polarization mode dispersion arises from the fact that even a single mode can have two polarization states. These polarizations travel at slightly different speeds, thus spreading the signal. For a 100-km transmission distance, PMD limits the signal frequency to 40 GHz. The magnitude of PMD in a fiber is expressed as this difference, which is known as the differential group delay (DGD) and called $\Delta\tau$ ("delta Tau").

Each type of dispersion mechanism leads to pulse spreading. As a pulse spreads, energy is overlapped. This condition is shown in figure 2-26. The spreading of the optical pulse as it travels along the fiber limits the information capacity of the fiber.

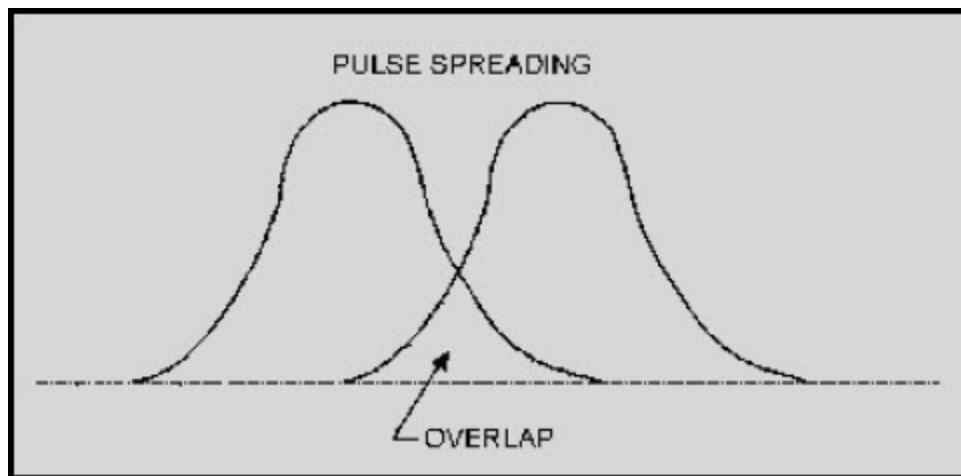

Figure 2-26. - Pulse overlap

In multimode fibers, waveguide dispersion and material dispersion are basically separate properties. Multimode waveguide dispersion is generally small compared to material dispersion. Waveguide dispersion is usually neglected. However, in single mode fibers, material and waveguide dispersion are interrelated. The total dispersion present in single mode fibers may be minimized by trading material and waveguide properties depending on the wavelength of operation.

Q46. Name the five types of dispersion.

Q47. Which dispersion mechanism (material or waveguide) is a function of the size of the fiber's core relative to the wavelength of operation?

Modal dispersion is the dominant source of dispersion in multimode fibers. Modal dispersion does not exist in single mode fibers. Single mode fibers propagate only the fundamental mode. Therefore, single mode fibers exhibit the lowest amount of total dispersion. Single mode fibers also exhibit the highest possible bandwidth.

Q48. Modes of a light pulse that enter the fiber at one time exit the fiber at different times. This condition causes the light pulse to spread. What is this condition called?

SUMMARY

Now that you have completed this chapter, let's review some of the new terms, concepts, and ideas that you have learned. You should have a thorough understanding of these principles before moving on to chapter 3.

A **LIGHTWAVE** is a form of energy that is moved by wave motion.

WAVE MOTION is defined as a recurring disturbance advancing through space with or without the use of a physical medium.

SCIENTIFIC EXPERIMENTS seem to show that light is composed of tiny particles, while other experiments indicate that light is made up of waves. Today, physicists have come to accept a theory concerning light that is a combination of particle (ray) theory and wave (mode) theory.

TRANSVERSE WAVE MOTION describes the up and down wave motion that is at right angle (transverse) to the outward motion of the waves.

LIGHT RAYS, when they encounter any substance, are either transmitted, refracted, reflected, or absorbed.

REFLECTION occurs when a wave strikes an object and bounces back (toward the source). The wave that moves from the source to the object is called the **incident wave**, and the wave that moves away from the object is called the **reflected wave**.

The **LAW OF REFLECTION** states that the angle of incidence is equal to the angle of reflection.

REFRACTION occurs when a wave traveling through two different mediums passes through the **boundary** of the mediums and bends toward or away from the **normal**.

The **RAY THEORY** and the **MODE THEORY** describe how light energy is transmitted along an optical fiber.

The **INDEX OF REFRACTION** is the basic optical material property that measures the speed of light in an optical medium.

SNELL'S LAW OF REFRACTION describes the relationship between the incident and the refracted rays when light rays encounter the boundary between two different transparent materials.

TOTAL INTERNAL REFLECTION occurs when light rays are totally reflected at the boundary between two different transparent materials. The angle at which total internal reflection occurs is called the **critical angle of incidence**.

The **CORE, CLADDING,** and **COATING** or **BUFFER** are the three basic parts of an optical fiber.

The **RAY THEORY** describes how light rays propagate along an optical fiber. **MERIDIONAL RAYS** pass through the axis of the optical fiber. **SKEW RAYS** propagate through an optical fiber without passing through its axis.

BOUND RAYS propagate through an optical fiber core by total internal reflection. **UNBOUND RAYS** refract out of the fiber core into the cladding and are eventually lost.

The **ACCEPTANCE ANGLE** is the maximum angle to the axis of the fiber that light entering the fiber is bound or propagated. The light ray incident on the fiber core must be within the acceptance cone defined by the acceptance angle to be propagated along an optical fiber.

NUMERICAL APERTURE (NA) is a measurement of the ability of an optical fiber to capture light.

The **MODE THEORY** uses electromagnetic wave behavior to describe the propagation of light along an optical fiber. A set of guided electromagnetic waves are called the **modes** of the fiber.

MODES traveling in an optical fiber are said to be transverse. Modes are described by their electric, $E(x,y,z)$, and magnetic, $H(x,y,z)$, fields. The electric field and magnetic field are at right angles to each other.

NORMALIZED FREQUENCY determines how many modes a fiber can support. The number of modes is represented by the normalized frequency constant.

SINGLE MODE and **MULTIMODE FIBERS** are classified by the number of modes that propagate along the optical fiber. Single mode fibers propagate only one mode because the core size approaches the operational wavelength. Multimode fibers can propagate over 100 modes depending on the core size and numerical aperture.

ATTENUATION is the loss of optical power as light travels along an optical fiber. Attenuation in an optical fiber is caused by absorption, scattering, and bending losses.

DISPERSION spreads the optical pulse as it travels along the fiber. Dispersion limits how fast information is transferred.

ABSORPTION is the conversion of optical power into another energy form, such as heat. **INTRINSIC ABSORPTION** is caused by basic fiber-material properties. **EXTRINSIC ABSORPTION** is caused by impurities introduced into the fiber material.

SILICA FIBERS are predominately used in fiber optic communications. They have low intrinsic material absorption at the wavelengths of operation.

The **WAVELENGTH OF OPERATION** in fiber optics is between 700 nm and 1600 nm. The wavelength of operation is between the ultraviolet (below 400 nm) and infrared (above 2000 nm) intrinsic absorption regions.

EXTRINSIC ABSORPTION occurs when impurities, such as hydroxyl ions (OH⁻), are introduced into the fiber. OH⁻ absorption peaks define three regions or windows of preferred operation. The first window is centered at 850 nm. The second window is centered at 1300 nm. The third window is centered at 1550 nm.

SCATTERING losses are caused by the interaction of light with density fluctuations within a fiber. **Rayleigh scattering** is the main source of loss in commercial fibers operating between 700 nm and 1600 nm.

MICROBENDS are small microscopic bends of the fiber axis that occur mainly when a fiber is cabled. **MACROBENDS** are bends having a large radius of curvature relative to the fiber diameter.

CHROMATIC DISPERSION occurs because light travels through different materials and different waveguide structures at different speeds. **MATERIAL DISPERSION** is dependent on the light wavelengths interaction with the refractive index of the core. **WAVEGUIDE DISPERSION** is a function of the size of the fiber's core relative to the wavelength of operation.

MODAL DISPERSION occurs because each mode travels a different distance over the same time span.

ANSWERS TO QUESTIONS Q1. THROUGH Q48.

- A1. *Photons.*
- A2. *Transverse-wave motion.*
- A3. *Light waves are either transmitted, refracted, reflected, or absorbed.*
- A4. *Transparent.*
- A5. *Opaque.*
- A6. *The law of reflection states that the angle of incidence is equal to the angle of reflection.*
- A7. *When the wave is nearly parallel to the reflecting surface.*
- A8. *When the wave is perpendicular to the reflecting surface.*
- A9. *The law of reflection.*
- A10. *Depends on the bending caused by the velocity difference of the wave traveling through different mediums.*
- A11. *Transmitted.*
- A12. *Diffusion.*
- A13. *The ray theory and the mode theory.*
- A14. *The index of refraction.*
- A15. *Light will travel faster in an optical material that is less dense.*
- A16. *Part of the light ray is reflected back into the glass and part of the light ray is refracted (bent) as it enters the air.*
- A17. *Total internal reflection occurs when the angle of refraction approaches 90 degrees. This condition occurs when the angle of incidence increases to the point where no refraction is possible.*

- A18. *Critical angle of incidence.*
- A19. *Core, cladding, and coating or buffer.*
- A20. *Core.*
- A21. *The ray theory.*
- A22. *Total internal reflection.*
- A23. *Smaller.*
- A24. *NA measures the light-gathering ability of an optical fiber.*
- A25. *Skew ray angle.*
- A26. *Modes of the fiber.*
- A27. *Direction, amplitude, and wavelength of propagation.*
- A28. *Yes, the wave front will disappear because the total amount of phase collected must be an integer multiple of 2π . (If the propagating wave fronts are out of phase, they will disappear. The wave fronts that are in phase interfere with the wave fronts out of phase. This type of interference is called destructive interference.)*
- A29. *Cutoff wavelength.*
- A30. *Multimode fiber.*
- A31. *The order of a mode is indicated by the number of field maxima within the core of the fiber. The order of a mode is also determined by the angle that the wave front makes with the axis of the fiber.*
- A32. *Mode coupling is the exchange of power between two modes.*
- A33. *Increase.*
- A34. $V \leq 2.405$.
- A35. *Decrease.*
- A36. *OM1, OM2, OM3, OM4*

- A37. *Light absorption, scattering, and bending losses.*
- A38. *Attenuation is the loss of optical power as light travels along the fiber.*
- A39. *Intrinsic and extrinsic material properties.*
- A40. *Ultraviolet absorption region (below 400 nm) and infrared absorption region (above 2000 nm).*
- A41. *The first, second, and third windows of operation are 850 nm, 1300 nm, and 1550 nm, respectively.*
- A42. *Rayleigh scattering.*
- A43. *(a) Mie scattering; (b) Rayleigh scattering.*
- A44. *Uneven coating applications, improper cabling procedures, and external force.*
- A45. *Fiber sensitivity to bending losses can be reduced if the refractive index of the core is increased and/or if the overall diameter of the fiber increases.*
- A46. *Modal, Material, waveguide, chromatic, and polarization mode.*
- A47. *Waveguide dispersion.*
- A48. *Modal dispersion.*

CHAPTER 3

OPTICAL FIBERS AND CABLES

LEARNING OBJECTIVES

Upon completion of this chapter, you should be able to do the following:

1. Describe multimode and single mode step-index and graded-index fibers.
2. Explain the different specialty fibers available.
3. List the performance advantages of 62.5/125 μm multimode graded-index fibers.
4. Identify the two basic types of single mode step-index fibers.
5. Describe the vapor phase oxidation and direct-melt optical fiber fabrication procedures.
6. Describe the fiber drawing process.
7. List the benefits of cabled optical fibers over bare fibers.
8. Identify the basic cable components, such as buffers, strength members, and jacket materials.
9. Describe the material and design requirements imposed on military fiber optic cable designs.
10. Describe the advantages and disadvantages of Breakout cable, Distribution cable, and Ribbon cable designs.
11. Describe Blown Optical Fiber installation, advantages and processes.

OPTICAL FIBER AND CABLE DESIGN

Optical fibers are thin cylindrical dielectric (non-conductive) waveguides used to send light energy for communication. Optical fibers consist of four parts: the core, the cladding, the acrylate coating and buffer. The choice of optical fiber materials and fiber design depends on operating conditions and intended application. Optical fibers are protected from the environment by incorporating the fiber into some type of cable structure. Cable strength members and outer jackets protect the fiber. Optical cable structure and material composition depend on the conditions of operation and the intended application.

OPTICAL FIBERS

Chapter 2 classified optical fibers as either single mode or multimode fibers. Fibers are classified according to the number of modes that they can propagate. Single mode fibers can propagate only the fundamental mode. Multimode fibers can propagate hundreds of modes. However, the classification of an optical fiber depends on more than the number of modes that a fiber can propagate.

An optical fiber's refractive index profile and core size further distinguish single mode and multimode fibers. The **refractive index profile** describes the value of refractive index as a function of radial distance at any fiber diameter. Fiber refractive index profiles classify single mode and multimode fibers as follows:

- Multimode step-index fibers
- Multimode graded-index fibers
- Single mode step-index fibers

In a **step-index** fiber, the refractive index of the core is uniform and undergoes an abrupt change at the core-cladding boundary. Step-index fibers obtain their name from this abrupt change called the step change in refractive index. In **graded-index** fibers, the refractive index of the core varies gradually as a function of radial distance from the fiber center.

Multimode fibers can have a step-index or graded-index refractive index profile. The performance of multimode graded-index fibers is superior to multimode step-index fibers. However, each type of multimode fiber can improve system design and operation depending on the intended application. Single mode fiber production is exclusively step-index. Figure 3-1 shows the refractive index profile for a multimode step-index fiber and a multimode graded-index fiber. Figure 3-1 also shows the refractive index profile for a single mode step index fiber. Since light propagates differently in each fiber type, figure 3-1 shows the propagation of light along each fiber.

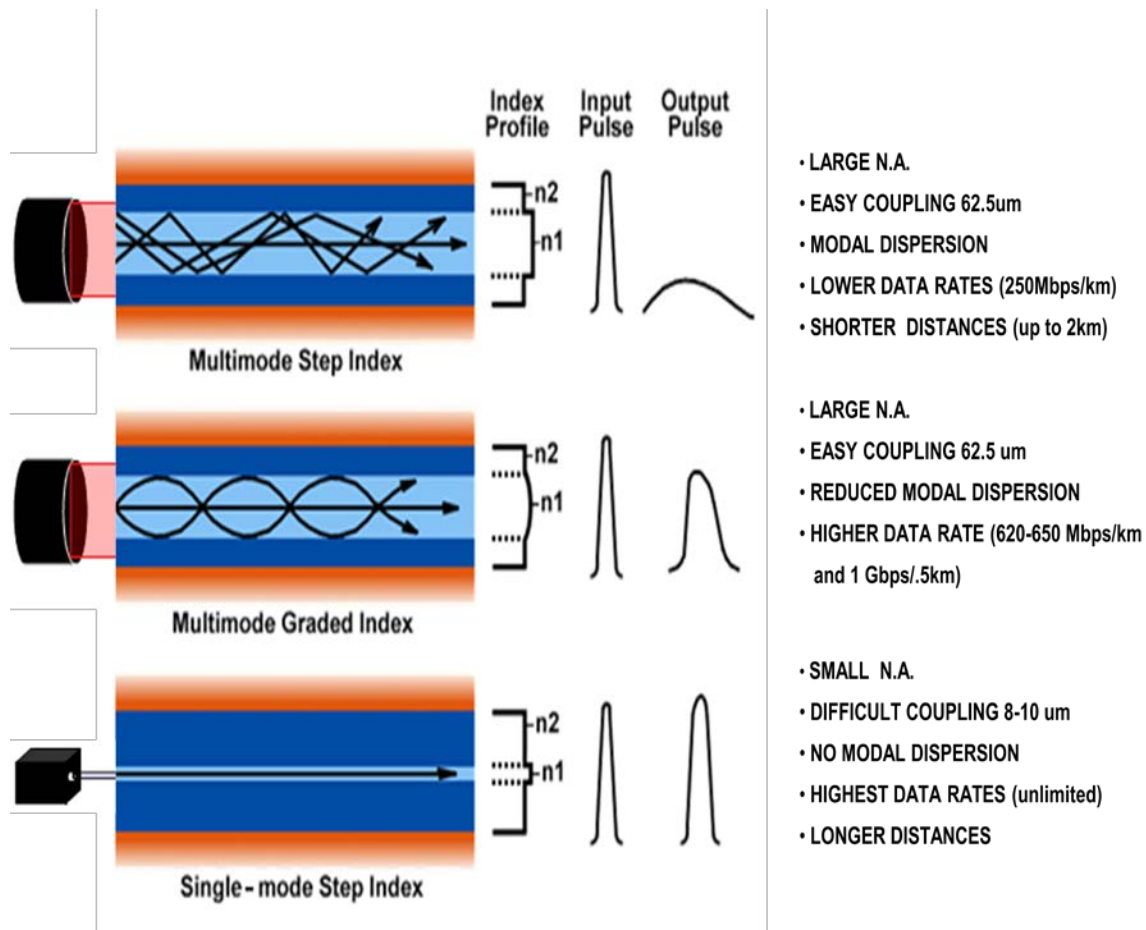

Figure 3-1. - The refractive index profiles and light propagation in multimode step-index, multimode graded-index, and single mode step-index.

In chapter 2, you learned that fiber core size and material composition can affect system performance. A small change in core size and material composition affects fiber transmission properties, such as attenuation and dispersion. When selecting an optical fiber, the system designer decides which fiber core size and material composition is appropriate.

Standard core sizes for multimode step-index fibers are 50 μ m, and 100 μ m. Standard core sizes for multimode graded-index fibers are 50 μ m and 62.5 μ m, 85 μ m, and 100 μ m. Standard core sizes for single mode fibers are between 8 μ m and 10 μ m. In most cases, the material used in the preparation of optical fibers is high-quality glass (SiO₂). This glass contains very low amounts of impurities, such as water or elements other than silica and oxygen. Using high-quality glass produces fibers with low losses. Small amounts of some elements other than silica and oxygen are added to the glass material to change its index of refraction. These elements are called material dopants. Silica doped with various materials forms the refractive index profile of the fiber core and material dopants are discussed in more detail later in this chapter. Glass is not the only material used in fabrication of optical fibers. Plastics are also used for core and cladding materials in some applications.

A particular optical fiber design can improve fiber optic system performance. Each single mode or multimode, step-index or graded-index, glass or plastic, or large or small core fiber has an intended application. The system designer must choose an appropriate fiber design that optimizes system performance in his application.

Q1. Describe the term "refractive index profile."

Q2. The refractive index of a fiber core is uniform and undergoes an abrupt change at the core cladding boundary. Is this fiber a step-index or graded-index fiber?

Q3. Multimode optical fibers can have a step-index or graded-index refractive index profile. Which fiber, multimode step-index or multimode graded-index fiber, usually performs better?

Q4. List the standard core sizes for multimode step-index, multimode graded-index, and single mode fibers.

Multimode Step-Index Fibers

A multimode step-index fiber is a simple fiber consisting of two layers of material, the core and the cladding, which have different refractive indexes. Where they come in contact with each other there is an abrupt change, see figure 3-2. This distinct difference in the density of glass between the core and cladding affects how fast the light will propagate through the material. The denser the material the slower the light will travel. Therefore, because the core is more dense (having a larger refractive index) than the cladding the light will travel slower within it.

When light speeds up it will bend. The density of the cladding is significantly less than the core. The light when it tries to enter the cladding speeds up so ferociously that it not only bends but reflects (just like a mirror) off the core/cladding boundary with effectively no loss whatsoever.

The number of modes that multimode step-index fibers propagate depends on the diameter of the core and index of refraction (n). Propagating modes also depends on the wavelength (λ) of the transmitted light. In a typical multimode step-index fiber, there are hundreds of propagating modes.

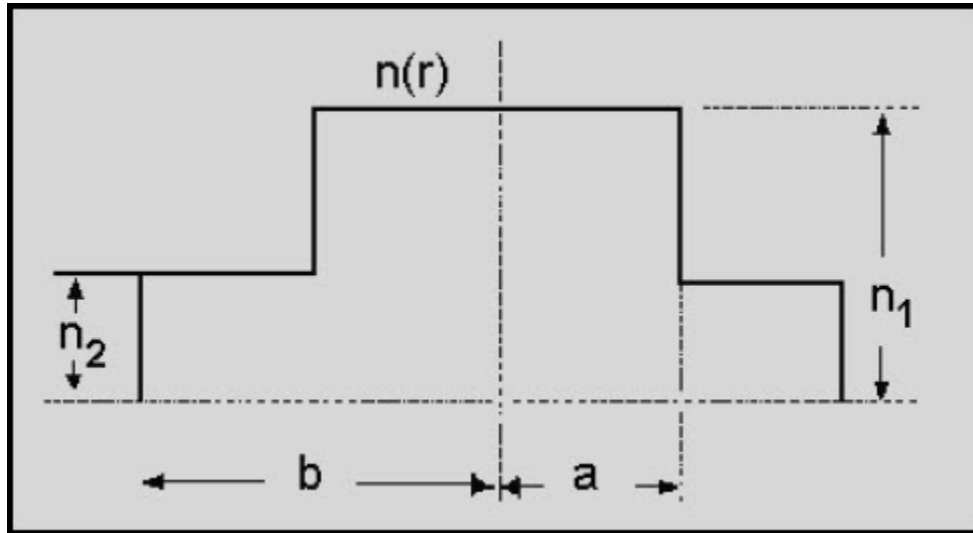

Figure 3-2. - The refractive index profile for multimode step-index fibers

Most modes in multimode step-index fibers propagate far from cutoff. Modes that are cut off cease to be bound to the core of the fiber. Modes that are farther away from the cutoff wavelength concentrate most of their light energy into the fiber core. Modes that propagate close to cutoff have a greater percentage of their light energy propagate in the cladding. Since most modes propagate far from cutoff, the majority of light propagates in the fiber core. Therefore, in multimode step-index fibers, cladding properties, such as cladding diameter, have limited effect on mode (light) propagation.

Multimode step-index fibers have relatively large core diameters and large numerical apertures. A large core size and a large numerical aperture make it easier to couple light from a light-emitting diode (LED) into the fiber. Multimode step-index fiber core size is typically 50 μm or 100 μm . Unfortunately; multimode step-index fibers have limited bandwidth capabilities. Dispersion, mainly modal dispersion, limits the bandwidth or information-carrying capacity of the fiber. System designers consider each factor when selecting an appropriate fiber for each particular application.

Multimode step-index fiber selection depends on system application and design. Short-haul, limited bandwidth, low-cost applications typically use multimode step-index fibers.

Q5. Multimode step-index fibers have a core and cladding of constant refractive indexes. Which refractive index, the core or cladding, is lower?

Q6. In multimode step-index fibers, the majority of light propagates in the fiber core for what reason?

Q7. Multimode step-index fibers have relatively large core diameters and large numerical apertures. These provide what benefit?

Multimode Graded-Index Fibers

As communication engineers began seriously investigating fiber optics in the early 1970's, they recognized modal dispersion limited the capacity of large-core step-index fiber. As an alternative, they developed multi-mode fiber in which the refractive index grades slowly from core to cladding. This process nearly eliminates modal dispersion in fibers with cores tens of micrometers in diameter, giving them much greater transmission capacity than step-index multi-mode fibers.

A multimode graded-index fiber has a core made of hundreds of layers with the densest layer exactly in the center of the core. As you move away from the center each subsequent layer is slightly less dense than the layer within it. Therefore, a light ray traveling down the center axis is traveling in the densest region of the fiber and is moving the slowest. The further the light goes from the axis of the fiber, the faster its velocity. The difference isn't great but it's enough to compensate for the longer distance the light travels. The idea is to get all the modes to exit the fiber as close as possible to reduce the spreading of the light pulse. Engineers have perfected this process to almost eliminate modal dispersion by equalizing the transmit modes of different wavelengths.

Figure 3-3 shows a possible refractive index profile $n(r)$ for a multimode graded-index fiber. Notice the parabolic refractive index profile of the core $n(r)$. This represents the change in the core's refractive index profile (n).

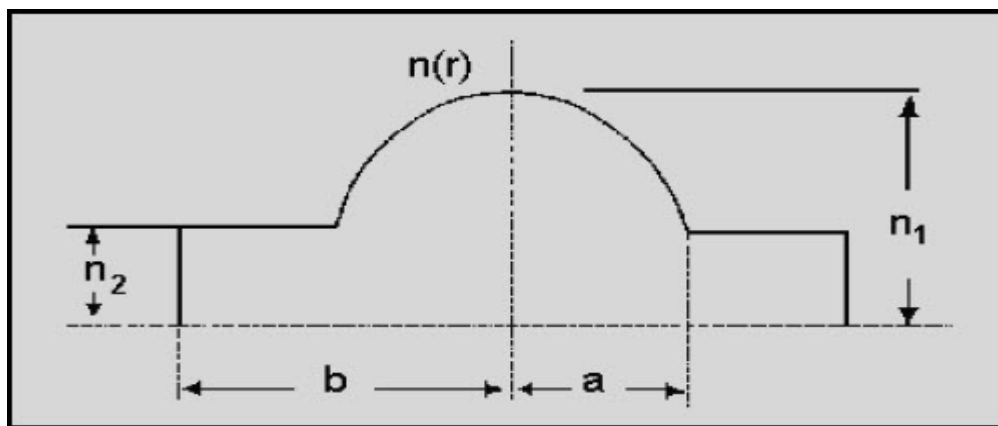

Figure 3-3. - The refractive index profile for multimode graded-index fibers

Light propagates in multimode graded-index fibers according to refraction and total internal reflection. The gradual decrease in the core's refractive index from the center of the fiber causes the light rays to be refracted many times. The light rays become refracted or curved, which increases the angle of incidence at the next point of refraction.

Total internal reflection occurs when the angle of incidence becomes larger than the critical angle of incidence. Figure 3-4 shows the process of refraction and total internal reflection of light in multimode graded-index fibers.

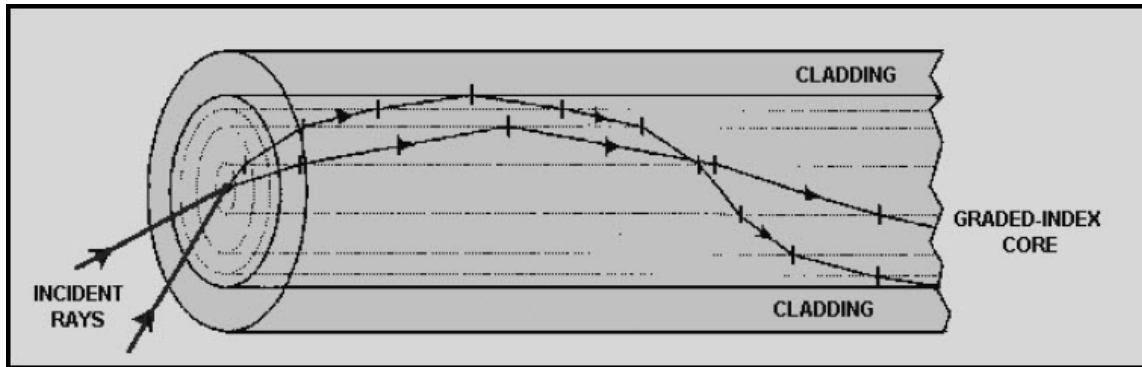

Figure 3-4. - Refractive index grading and light propagation in multimode graded-index fibers

Graded-index fibers were developed especially for communications. The long-time standard types have core diameters of 50 and 62.5 μm and cladding diameters of 125 μm . The core diameters are large enough to collect light efficiently from a variety of light sources. The cladding must be at least 20 μm thick to keep light from leaking out. Graded-index fibers are primarily used in Local Area Network (LAN) topologies typically less than two kilometers in length.

Multimode graded-index fibers accept less light than multimode step-index fibers with the same core size. However, graded-index fibers usually outperform the step-index fibers. The core's parabolic refractive index profile causes multimode graded-index fibers to have less modal dispersion.

Most present day applications that use multimode fiber use graded-index fibers. The basic design parameters are the fiber's core and cladding size. Standard multimode graded-index fiber core and cladding sizes are 50/125 μm , 62.5/125 μm , 85/125 μm , and 100/140 μm . Although no single multimode graded-index fiber design is appropriate for all applications, the 62.5/125 μm fiber offers the best overall performance and has been selected for most of the multi-mode systems on board Navy ships.

A multimode graded-index fiber's source-to-fiber coupling efficiency and insensitivity to microbending and macrobending losses are its most distinguishing characteristics. The fiber core size affects the amount of power coupled into the core and loss caused by microbending and macrobending. In most applications, a multimode graded-index fiber with a core and cladding size of 62.5/125 μm offers the best combination of the following properties:

- Relatively high source-to-fiber coupling efficiency
- Low loss

- Low sensitivity to microbending and macrobending
- High bandwidth
- Expansion capability

For example, local area network (LAN) and shipboard applications use multimode graded-index fibers with a core and cladding size of 62.5/125 μm . In LAN-type environments, macrobend and microbend losses are hard to predict. Cable tension, bends, and local tie-downs increase macrobend and microbend losses. In shipboard applications, a ship's cable-way may place physical restrictions, such as tight bends, on the fiber during cable plant installation. The good microbend and macrobend performance of 62.5/125 μm fiber permits installation of a rugged and robust cable plant. 62.5/125 μm multimode graded-index fibers allow for uncomplicated growth because of high fiber bandwidth capabilities for the expected short cable runs on board ships.

Q8. How is a multi-mode graded-index core constructed?

Q9. How does light propagate in multimode graded-index fiber?

Q10. How thick must the cladding be to ensure the light does not leak out?

Q11. Where is graded-index fibers primarily used?

Q12. What multimode graded-index fiber offers the best overall performance for most applications?

Q13. What are the most distinguishing characteristics of a multimode graded-index fiber?

Single Mode Step-Index Fibers

The basic requirement for single-mode fiber is that the core be small enough to restrict transmission to a single mode. This lowest-order mode can propagate in all fibers with smaller cores (as long as light can physically enter the fiber. Because single-mode

transmission avoids modal dispersion, modal noise, and other effects that come with multi-mode transmission, single-mode fibers can carry signals at much higher speeds than multi-mode fibers. They are the standard choice for virtually all kinds of telecommunications that involve high data rates or span distances longer than about a kilometer and are often used at slower speeds and shorter distances as well.

The simplest type of single-mode fiber, often called standard single-mode, has a step-index profile, with an abrupt boundary separating a high-index core and a lower index cladding. The simplest design is the matched-cladding fiber shown by figure 3-5. The cladding is pure fused silica; germanium oxide (GeO_2) is added to the core to increase its refractive index.

An alternative design is the depressed cladding fiber shown in figure 3-6. In this case, the core is fused silica doped with less germanium oxide than is needed for a matched cladding fiber. The inner part of the cladding surrounding the core is doped with fluorine, which reduces its refractive index below that of pure silica. The outermost part of the core is pure fused silica, without the fluorine dopant.

Both these designs typically are used for 1310 μm transmission with core diameters around 9 μm .

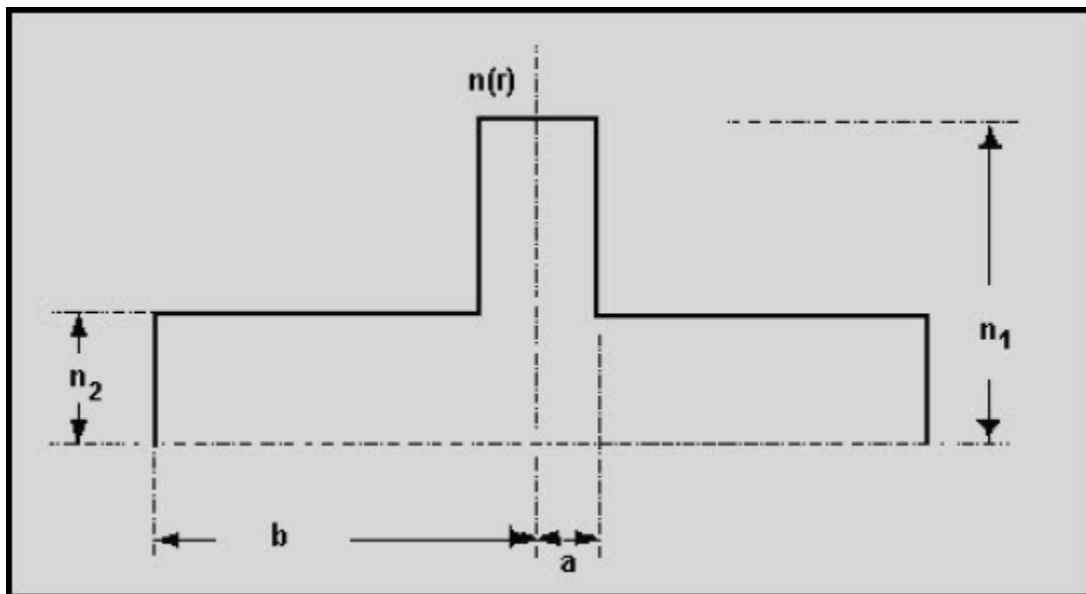

Figure 3-5. - Matched-clad refractive index profile

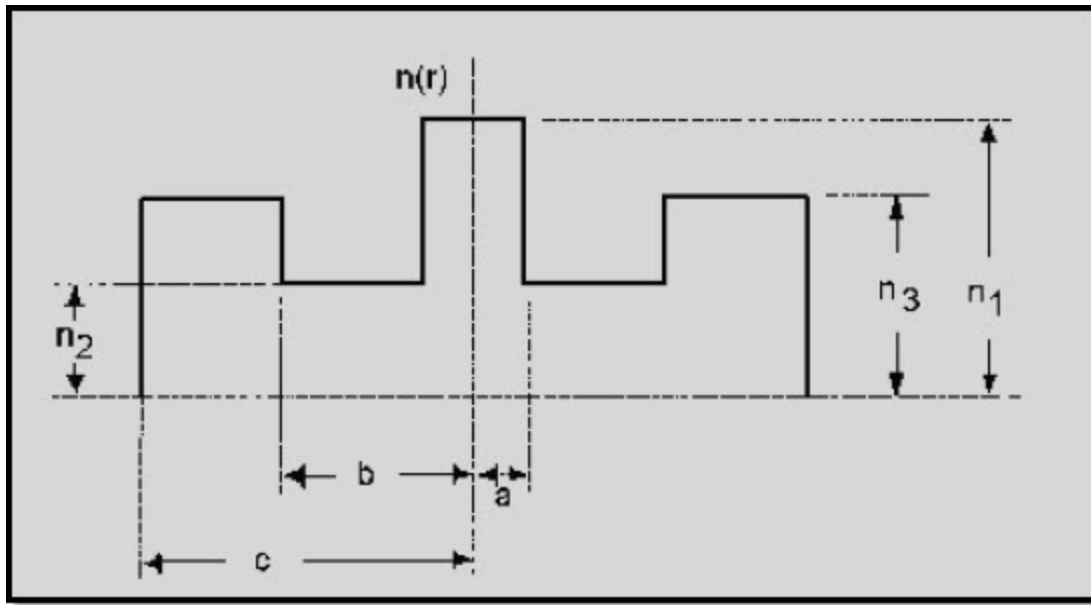

Figure 3-6. - Depressed-clad refractive index profile

Single mode fiber cutoff wavelength is the smallest operating wavelength when single mode fibers propagate only the fundamental mode. At this wavelength, the 2nd-order mode becomes lossy and radiates out of the fiber core. As the operating wavelength becomes longer than the cutoff wavelength, the fundamental mode becomes increasingly lossy. The higher the operating wavelength is above the cutoff wavelength, the more power is transmitted through the fiber cladding. As the fundamental mode extends into the cladding material, it becomes increasingly sensitive bending loss. Single mode fiber designs include claddings of sufficient thickness with low absorption and scattering properties to reduce attenuation of the fundamental mode.

A single mode step-index fiber has low attenuation and high bandwidth properties. Present applications for single mode fibers include long-haul, high-speed telecommunication systems, Metropolitan Area Networks (MANs), Wide Area Networks (WANs), Global Area Networks (GANs), Fiber-to-the-Home and system backbones. Installation and maintenance of single mode systems can be expensive due to the complexity of the electronics involved. Currently, shipboard installations of single mode fiber are on the increase. New systems such as unmanned aircraft (i.e. SCAN Eagle, Predator, Reaper and X47), ISNS, ICAN, CANES, and numerous others are driving the system designers to increase bandwidth to support these integrated systems.

Q14. What are the two basic types of single mode step-index fibers?

Q15. Which fiber cladding, matched or depressed, consists of two regions?

Q16. What happens to the fundamental mode as the operating wavelength becomes longer than the single mode cutoff wavelength?

Single Mode Specialty Fibers

There are several types of single mode specialty fibers. These fibers are not standard fibers and are typically only used in specialty applications. Information on single mode graded-index fibers can be found in the references in appendix 2.

Fiber Alternatives

In most applications, the standard multimode and single mode optical fibers mentioned before have significant performance advantages over conventional copper-based systems. However, performance requirements may prohibit the use of these fibers in certain applications. Fiber manufacturers modify standard multimode and single mode fiber material composition and structural design to meet these additional requirements. Optical fiber design can depart from a traditional circular core and cladding, low-loss glass design. The intent of each change is to increase performance.

Optical fibers composed of plastic have been in use longer than glass fibers. Types of standard fibers using plastics include multimode step-index and graded-index fibers. Multimode step-index and graded-index **plastic clad silica** (PCS) fibers exist. PCS fibers have a silica glass core and a plastic cladding. Normally, PCS fibers are cheaper than all-glass fibers but have limited performance characteristics. PCS fibers lose more light through a plastic cladding than a glass cladding.

Multimode step-index fibers may also have a plastic core and cladding. All-plastic fibers have a higher NA, a larger core size, and cost less to manufacture. However, all-plastic fibers exhibit high loss in the thousands of decibels per kilometer. This high loss is caused by impurities and intrinsic absorption. PCS and all-plastic fibers are used in applications typically characterized by one or all of the following:

- High NA
- Low bandwidth
- Tight bend radius
- Short length (less than 10m to 20m)
- Low cost

One industry that is embedding plastic fibers into their products is the automobile industry. Plastic fibers are now being installed in automobiles as part of their

infotainment system. This system comprises GPS navigation, video entertainment, satellite radio, backup camera, broadband satellite communication, climate control, ride control, onboard telephone and security.

Improved fabrication techniques provide the opportunity to experiment with material composition in both multimode and single mode fibers. Fiber manufacturers fabricate optical fibers using glass material whose characteristics improve system performance in the far infrared region. Fiber manufacturers add dopant material to reduce fiber loss and limit material and structural imperfections. Fiber material used in fabrication of low-loss, long wavelength optical fibers include the following:

- Heavy-metal fluorides (such as zirconium and beryllium fluoride)
- Chalcogenide glasses (such as arsenic/sulfur)
- Crystalline materials (such as silver bromide and silver chloride)

Other types of specialty fibers include; Dispersion Shifted, Zero Dispersion Shifted, Nonzero Dispersion Shifted and Polarization in single-mode fibers. Each of these fibers has specific applications in the commercial sector.

In shipboard applications, stringent environmental requirements dictate the design of optical fibers. In the commercial sector riser cables are used for vertical cable runs and plenum cables are used in horizontal cable runs within buildings. Each type of cable has fire retardant capabilities as specified by the National Electric Code (NEC). Both of these cable types are not authorized for shipboard use.

Riser cables are vertical cables that are run and housed in the walls of the building. They are constructed so that they put out a fire by producing a large amount of smoke. The smoke displaces the oxygen in the fire zone and snuffs the fire out. Plenum cables are run in the horizontal areas in a building found under raised floors or above the dropped ceiling tiles. These areas are also where air handling ducts are placed. Because air is constantly moving in these areas Riser cables are not effective in putting out a fire so Plenum cables have to be used.

Plenum cables have Halogens in the form of Chlorine and Fluorine impregnated into the cabling jackets. When the cables are exposed to flame the Halogens form Chlorine and Fluorine gas. The oxygen molecules readily attach themselves to the Halogen molecules holding them out of the fire zone effectively putting the fire out. This process works exceptionally well in buildings but, is not desirable on board Naval ships. Large amounts of smoke or Halogens in the confined spaces where sailors live and work are extremely dangerous and toxic to life. The Navy needs fire retardant cables but not in the form of Riser or Plenum.

Low-Smoke-Zero-Halogen (LSZH) style cables are the approved cable types for Naval ships. As its name implies this cable process produces low, releases no halogens,

and emit very limited amounts of other toxins. They come in the form of either Thermoset or Thermoplastic. The difference between the two different styles are in how they are manufactured. Thermoset cables are chemically bonded and radiated. This process tightly cross-links the molecules in the cables so when they are exposed to flame they will not burn or melt and flow but will char and hold onto the cable.

Thermoplastic cables are manufactured by placing the cables in ovens and preheating them. This has the effect of loosely cross-linking the molecules so the cables will not burn but, will melt and flow. Both of these cables are designated by part numbers beginning with **MIL-PRF-85045**.

Q17. Why do optical fiber manufacturers depart from the traditional circular core and cladding, low-loss glass fiber design?

Q18. What five characteristics do applications using plastic clad silica (PCS) and all-plastic fibers typically have?

Q19. List the types of materials used in fabricating low-loss, long wavelength optical fibers.

Q20. What is the difference between Thermoset and Thermoplastic cables..

Fabrication of Optical Fibers

Basically, fiber manufacturers use two methods to fabricate multimode and single mode glass fibers. One method is vapor phase oxidation, and the other method is direct-melt process. In **vapor phase oxidation**, gaseous metal halide compounds, dopant material, and oxygen are oxidized (burned) to form a white silica powder (SiO_2). Manufacturers call SiO_2 the **soot**. Manufacturers deposit the soot on the surface of a glass substrate (mandrel) or inside a hollow tube by one of the following three methods:

- Outside Vapor Phase Oxidation (OVPO).
- Inside Vapor Phase Oxidation (IVPO).
- Vapor Phase Axial Deposition (VAD).

The soot forms the core and cladding material of the preform. The refractive index of each layer of soot is changed by varying the amount of dopant material being

oxidized. Figures 3-7, 3-8, and 3-9 illustrate the different vapor phase oxidation preform preparation methods.

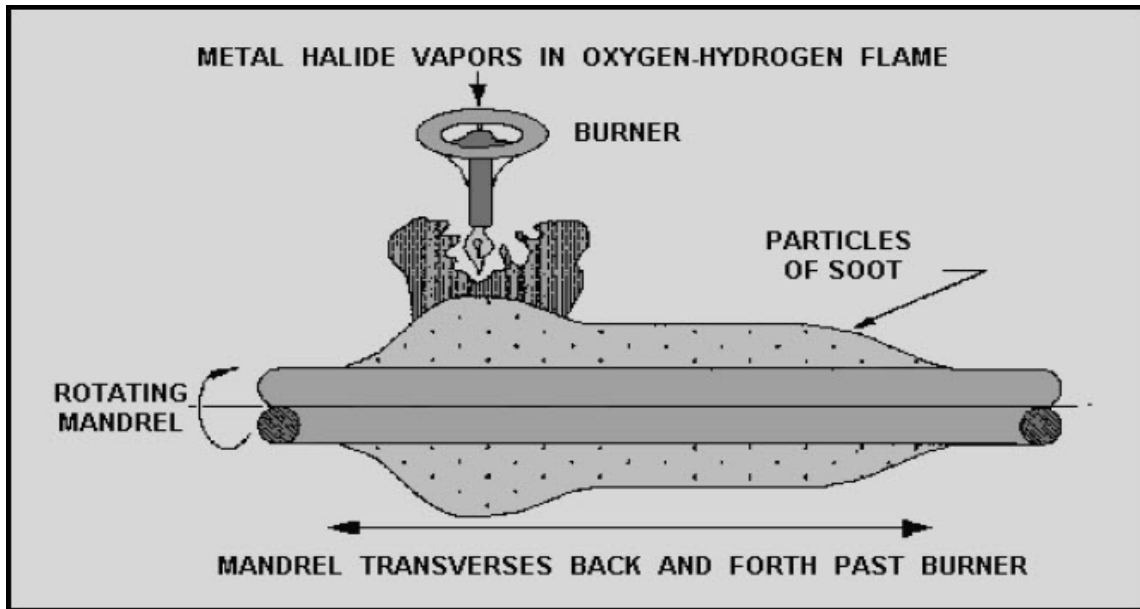

Figure 3-7. - OVPO preform preparation

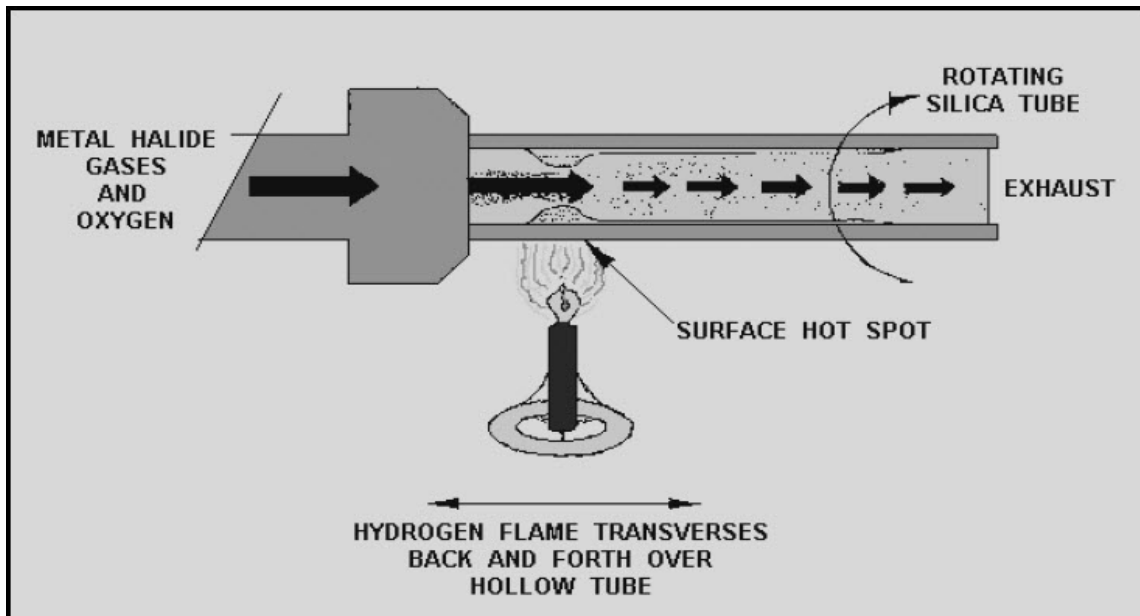

Figure 3-8. - IVPO preform preparation

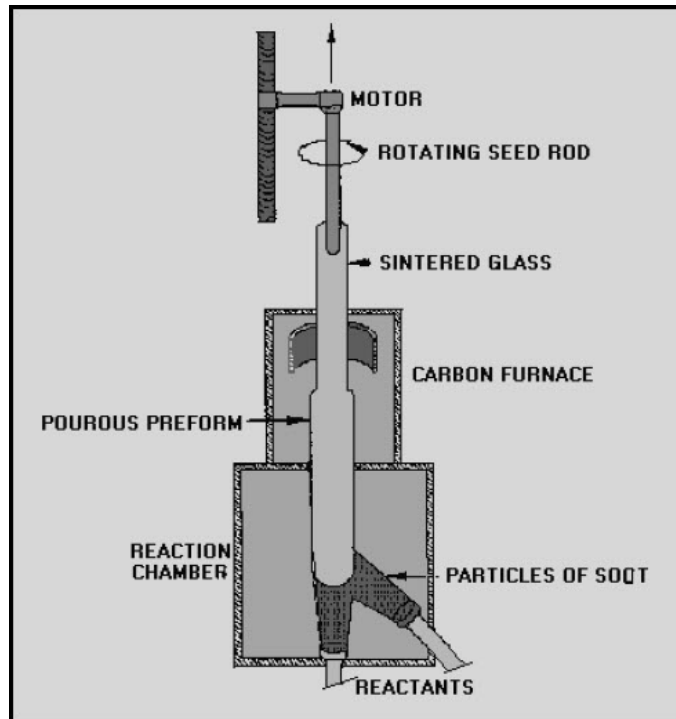

Figure 3-9. - VAD preform preparation

During vapor phase oxidation, the mandrel or tube continuously moves from side to side and rotates while soot particles are deposited on the surface. This process forms cylindrical layers of soot on the surface of the mandrel or inside the hollow tube. This deposited material is transformed into a solid glass preform by heating the porous material (without melting). The solid preform is then drawn or pulled into an optical fiber by a process called fiber drawing.

The fiber drawing process begins by feeding the glass preform into the drawing furnace. The drawing furnace softens the end of the preform to the melting point. Manufacturers then pull the softened preform into a thin glass filament (glass fiber). To protect the bare fiber from contaminants, manufacturers add an acrylate coating in the draw process. The coating protects the bare fiber from contaminants such as atmospheric dust and water vapor. Figure 3-10 illustrates the process of drawing an optical fiber from the preform.

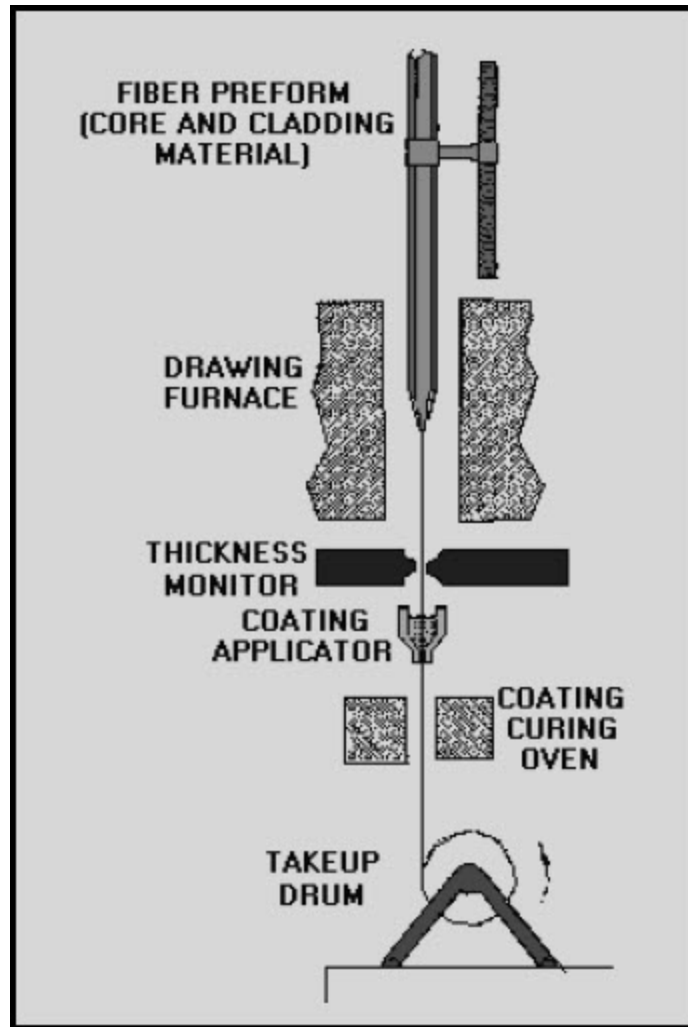

Figure 3-10. - Fiber drawing process

In the **direct-melt process**, multicomponent glass rods form the fiber structure. Rods of multicomponent glass combine in a molten state to form the fiber core and cladding. The double-crucible method is the most common direct-melt process. The double-crucible method combines the molten rods into a single preform using two concentric crucibles. Optical fibers are drawn from this molten glass using a similar fiber drawing process as in vapor phase oxidation. Figure 3-11 illustrates the double-crucible drawing process.

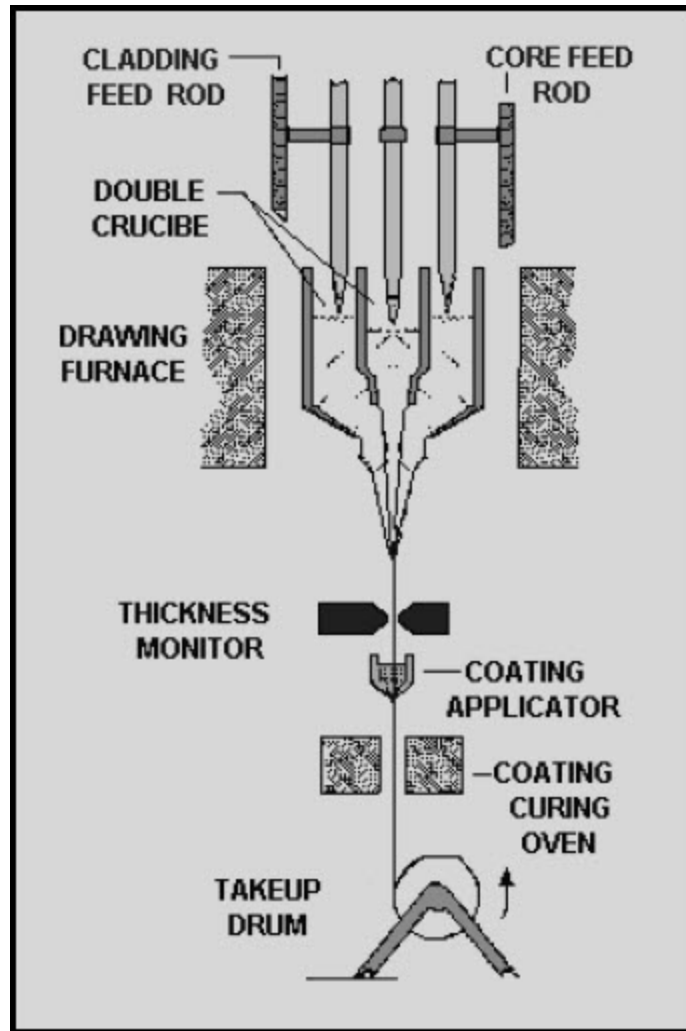

Figure 3-11. - Double-crucible fiber drawing process

Q21. What are the two methods used by fiber manufacturers to fabricate multimode and single mode glass fibers?

Q22. Which method, vapor phase oxidation or direct-melt process, transforms deposited material into a solid glass preform by heating the porous material without melting?

OPTICAL CABLES

Optical fibers have small cross sectional areas. Without protection, optical fibers are fragile and can be broken. The optical cable structure protects optical fibers from environmental damage. Cable structure includes buffers, strength members, and jackets. Many factors influence the design of fiber optic cables. The cable design relates to the

cable's intended application. Properly designed optical cables perform the following functions:

- Protect optical fibers from damage and breakage during installation and over the fiber's lifetime.
- Provide stable fiber transmission characteristics compared with uncabled fibers. Stable transmission includes stable operation in extreme climate conditions.
- Maintain the physical integrity of the optical fiber by reducing the mechanical stresses placed on the fiber during installation and use. Static fatigue caused by tension, torsion, compression, and bending can reduce the lifetime of an optical fiber.

Navy applications require that fiber optic cables meet stringent design specifications. Fiber optic cables must be rugged to meet the optical, environmental, and mechanical performance requirements imposed by Navy systems. Critical system downtime caused by cable failure cannot be tolerated. However, in commercial applications, the requirements imposed on cable designs are not as stringent. Each additional requirement imposed on the fiber optic cable design adds to its cost. Cost is always a main consideration of cable designers in commercial applications. Cost is also considered in Navy applications, but system reliability is the main goal.

Q23. List three benefits that properly cabled optical fibers provide.

Fiber Buffers

Coatings and buffers protect the optical fiber from breakage and loss caused by microbends. During the fiber drawing process, the addition of a primary coating protects the bare glass from abrasions and other surface contaminants. For additional protection, manufacturers add a layer of buffer material. The buffer material provides additional mechanical protection for the fiber and helps preserve the fiber's inherent strength.

Manufacturers use a variety of techniques to buffer optical fibers. The types of fiber buffers include tight-buffered, loose-tube, and gel-filled loose-tube. Figure 3-12 shows each type of fiber buffer. The choice of buffering techniques depends on the intended application. In large fiber count commercial applications, manufacturers use the loose-tube buffers. In commercial building and Navy applications, manufacturers use tight buffers.

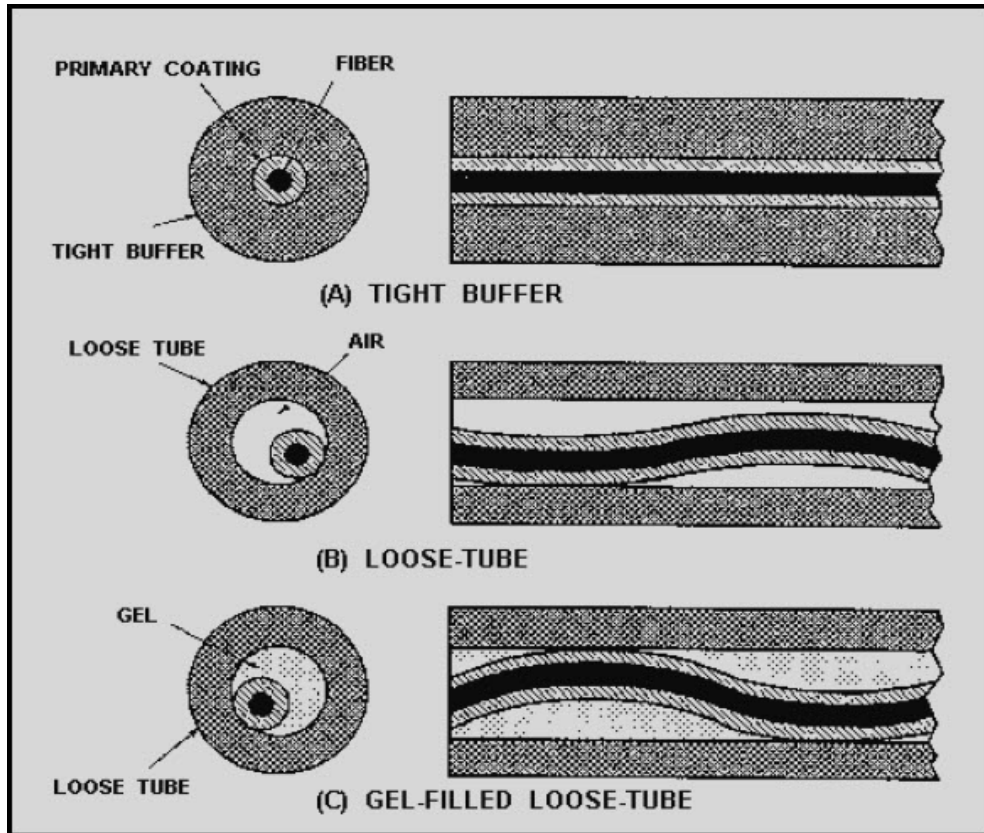

Figure 3-12a. - Tight-buffered, loose-tube, and gel-filled loose-tube buffer techniques

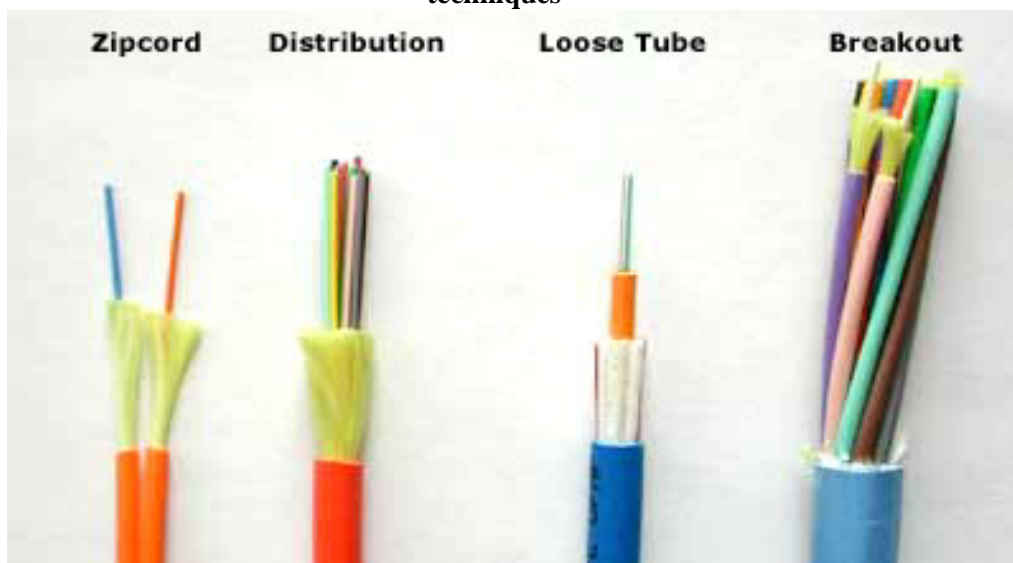

Figure 3-12b. - Cable Types

Q24. In addition to a primary coating, manufacturers add a layer of buffer material for what reasons?

Q25. List the three techniques used by manufacturers to buffer optical fibers.

Cable Strength and Support Members

Fiber optic cables use strength members to increase the cables' strength and protect the fiber from strain. Fiber optic cables may use central support members in cable construction. The central support members generally have buffered fibers or single fiber sub-cables stranded over their surface in a structured, helical manner. The central members may support the optical fibers as cable strength members or may only serve as fillers. Strength and support members must be light and flexible. In commercial applications, the materials used for strength and support include steel wire and textile fibers (such as nylon and aramid yarn). They also include carbon fibers, glass fibers, and glass reinforced plastics. For Navy applications, only non-metallic strength and support members are allowed.

Cable Jacket, or Sheath, Material

The jacket, or sheath, material provides extra environmental and mechanical protection. Jacket materials for Navy cables have the following properties:

- Low smoke generation
- Low toxicity
- Low halogen content
- Flame retardance
- Fluid resistance
- High abrasion resistance
- Stable performance over temperature

It is difficult to produce a material compound that satisfies every requirement without being too costly. Originally, the production of fire retardant cables included the use of halogenated polymers and additives. These fire retardant cables were also highly toxic. Commercial jacket materials currently used include polyethylene, polyvinyl chloride (PVC), polyurethane, and polyester elastomers.

Q26. List seven properties cable jackets should have.

Cable Designs

Manufacturers design fiber optic cables for specific applications. Is the cable buried underground or hung from telephone poles? Is the cable snaked through cableways, submerged in water, or just laid on the ground? Is the cable used in industrial, telecommunication, utility, or military applications? Each different application may require a slightly different cable design.

Agreement on standard cable designs is difficult. Cable design choices include jacket materials, water blocking techniques, and the number of fibers to place within the cable. The cable design chosen depends on the cable's intended application. There are presently many types of fiber optic cables. Some fiber optic cables are used in commercial applications, while others are used in military applications.

Navy systems require that fiber optic cables meet stringent environmental conditions. The only type of cable design that will meet the harsh conditions that the cables will be exposed to is tight buffered breakout. They are able to meet the minimal levels of performance in safety (low smoke, low toxicity, low halogen content, etc.), durability (able to withstand shock, vibration, fluids, etc.), and optical performance. The cable must also be easy to install and repair. These factors greatly influenced the design of the cables.

Tight Buffered Breakout Cable

A tight buffered breakout cable consists of individual single fiber cables, called **Optical Fiber Cable Components (OFCCs)**. OFCCs are a tight-buffered fiber surrounded by aramid yarn and a low-halogen outer jacket. The OFCC outer diameter is typically 2 millimeters (mm). The fiber is typically buffered with a polyester elastomer to a total diameter of 900 μm . Figure 3-13 illustrates the design of the OFCCs. The size of the OFCCs limits the amount of fibers contained within an OFCC cable. An OFCC cable generally contains less than 36 fibers (OFCCs). An OFCC cable of 0.5-inch cable outer diameter can accommodate about 12 fibers.

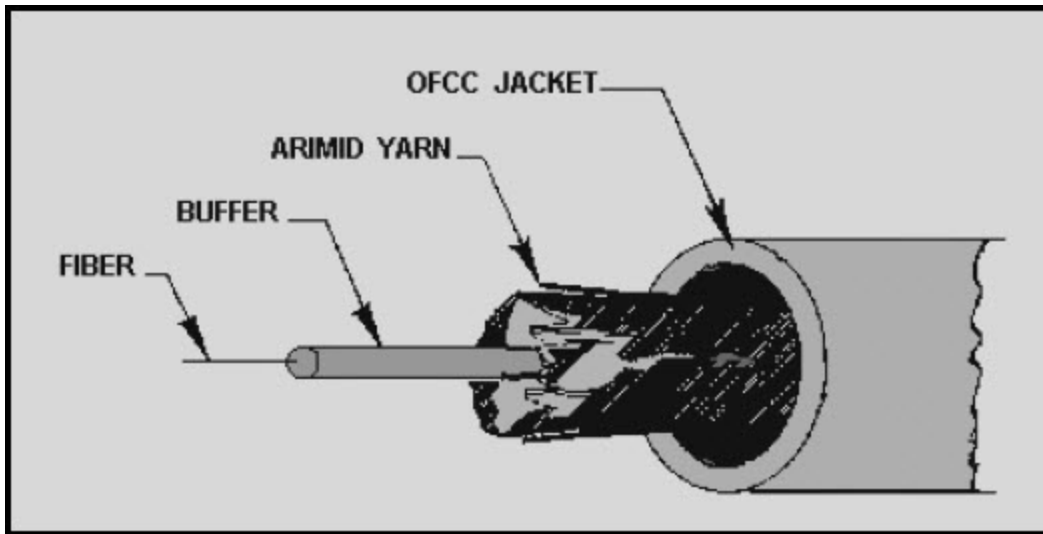

Figure 3-13. - The design of optical fiber cable components (OFCCs)

Figure 3-14 shows an isometric view of a breakout cable. In this multifiber cable design, the OFCCs surround a flexible central member in a helical manner. The central member may add to cable strength or only support the OFCCs. For additional protection, two layers of aramid yarn strength members encase the OFCC units. These strength members are stranded in opposing lays to minimize microbending of the fibers. The aramid yarn strength members may be treated with polymers that are water absorbing, blocking, and sealing. This treatment eliminates the need for additional water blocking protection. Finally, a low-halogen, flame-resistant outer jacket is extruded over the strength members.

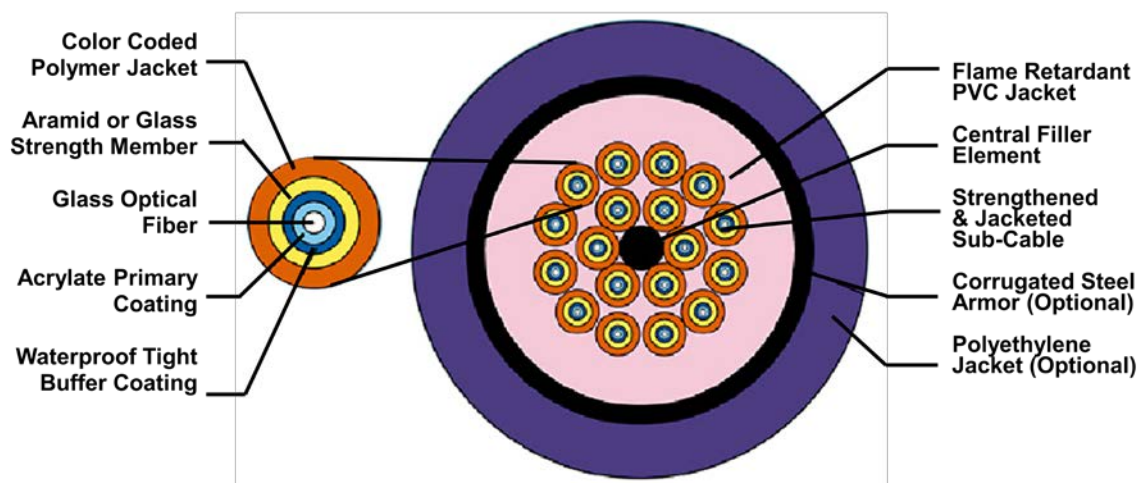

Figure 3-14. - Breakout Cable

Breakout cables are easy to handle because each cable contains its own subcable, the OFCC. These OFCC subcables make it easy to reconfigure systems and handle individual fibers. Rugged breakout cable design permits cable use in harsh environments,

including Navy applications. Breakout style cable is recommended for use in low-density (less than 90 fibers) Navy applications.

Tight Buffered Distribution Cable

A Distribution cable is a fiber optic cable consisting of buffered fibers stranded down the center of the cable surrounded by strength members and a protective jacket. Figure 3-15 shows a cross-sectional view of the distribution cable. The fiber is typically buffered with a polyester elastomer to a total diameter of 900 μm .

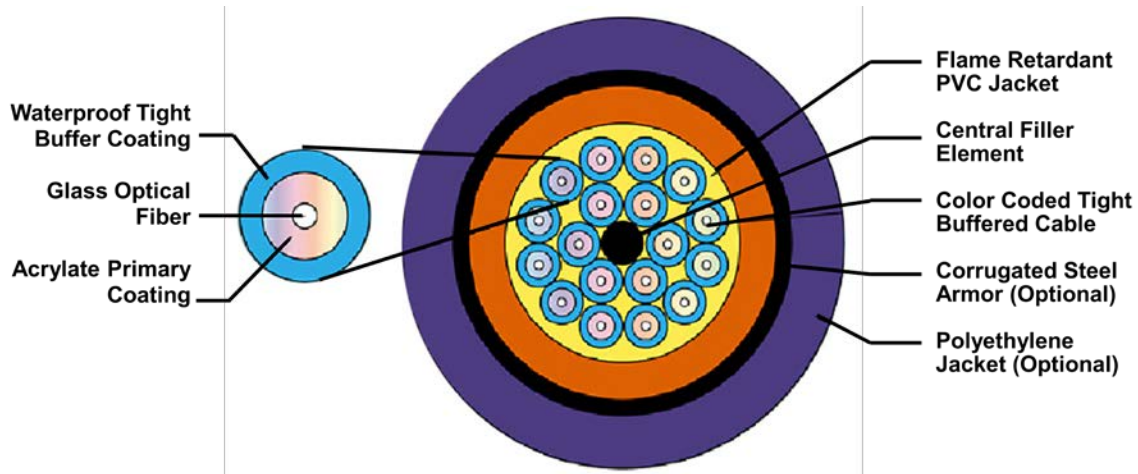

Figure 3-4. - Tight Buffered Distribution cable design

Distribution cable increases fiber counts without greatly increasing cable size. Distribution cables are used when fiber counts exceed the limits of Breakout style cables. For example, the distribution cable design can accommodate about 48 fibers in a 0.5-inch cable. The breakout cable design can accommodate around 12 fibers. The individual fiber is not protected as well in the distribution design as in the breakout design. For this reason more care is required in handling the individual fibers in the distribution cable.

Ribbon Cable

A ribbon cable consists of optical fiber ribbons stranded down the center of the cable surrounded by a protective tube, strength members, and an outer jacket. The fiber optic ribbon consists of multiple coated, 250 μm diameter fibers sandwiched in a plastic material. Figure 3-16 shows a cross-sectional view of a 12-fiber ribbon. Cable manufacturers stack these ribbons to form a rectangular cross-sectional array of fibers. Stacked ribbons are the basic building blocks of the ribbon cable. Figure 3-17 illustrates this cross-sectional array of ribbons. Manufacturers introduce a controlled twist to the stacked ribbons to minimize fiber stress when the cable is bent. An inner plastic tube, strength members, and an outer protective jacket surround the stacked ribbons, providing environmental protection.

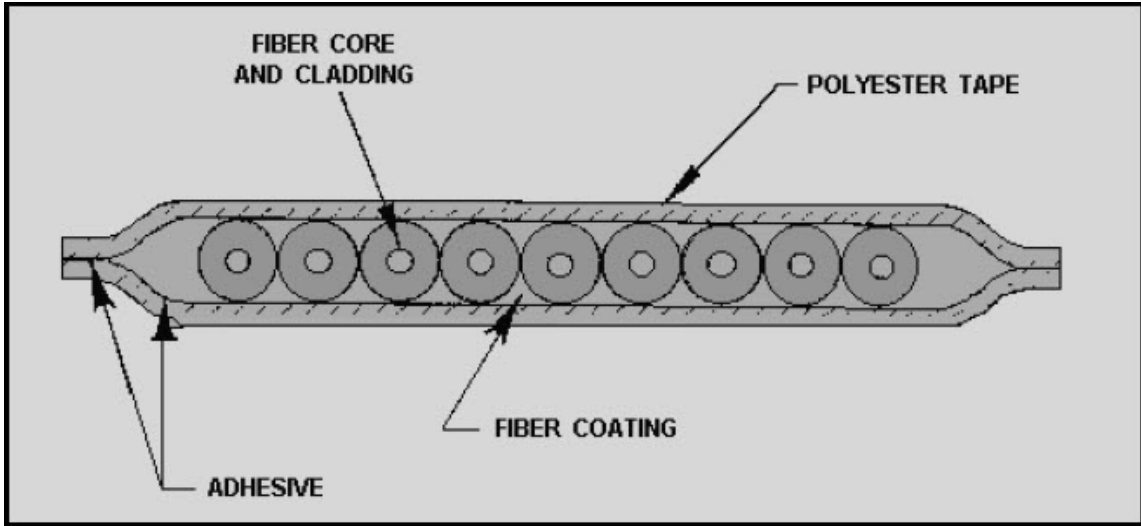

Figure 3-16. - Cross section of a fiber optic ribbon

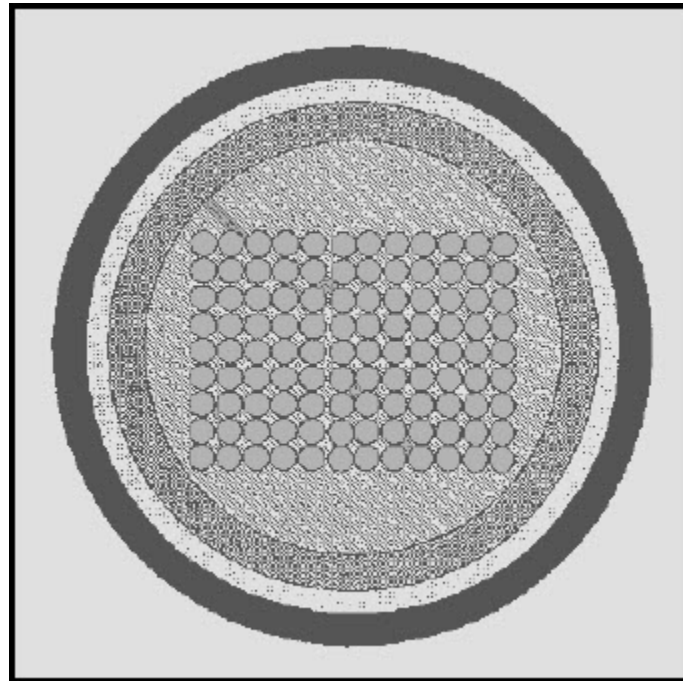

Figure 3-17. - Ribbon cable cross-sectional array of fibers

The ribbon cable design has the highest fiber capacity. Ribbon cables can hold 204 fibers in a 0.5-inch cable. However, ribbon cables have worse bend performance than Breakout and distribution cables. Ribbon cables also have the poorest water blocking capabilities of the three cable designs. The bend performance is expected to worsen if manufacturers add appropriate compounds to increase water blocking capabilities.

Ribbon cables are also hard to handle. Individual fibers are highly susceptible to damage when separated from the ribbon. This susceptibility to fiber damage during fiber breakout makes it necessary to perform multifiber connections. Multifiber connections can introduce single points of failure in multiple systems. The use of multifiber terminations also introduces maintenance, reconfiguration, and repair problems.

Q27. What type of cable design is used by the Navy.

Q28. Describe an optical fiber cable component (OFCC).

Q29. Two layers of aramid yarn strength members encase the OFCC units. Why are these strength members stranded in opposing directions?

Q30. Why do cable manufacturers introduce a controlled twist to the stacked ribbons during the cabling process?

Q31. Breakout, distribution, and ribbon cables have different fiber capacities. What is the approximate number of fibers that each cable can accommodate in a 0.5-inch cable?

Q32. Which fiber optic cable (breakout, distribution, or ribbon) has the worst bend performance?

Blown Optical Fiber (BOF)

Blown Optical Fiber (BOF) is an innovative alternative to the standard installation of a fiber optic cable plant. BOF is used in both military and commercial environments. These different environments have vastly different issues to contend with. In many instances, BOF technology is a superior alternative to conventional fiber optic cabling methods and installation practices. Both BOF and conventional fiber links have at least one common element. You have to install cables. The stress on a fiber optic cable created by the installation crew pulling it through the trays and around bends could be sufficient

to cause damage to the fiber cable. This may result in marginal link performance or failure at some time after the system has been acceptance tested.

BOF cable installation does not induce the tensile stresses on the fiber as stated above. BOF cables are installed with no fibers in the tubes within the cable. Fibers are blown into the pre-installed tube cables utilizing compressed air under no tension. By installing fiber in this manner the potential for damage is eliminated which could lead to increased attenuation (signal loss) or failure. Additional benefits of BOF are increased flexibility in the installation options, capacity for future growth, lower installed fiber attenuation and reduction in the number of interconnects.

The concept of blowing fiber cables has been around for quite some time. Air assisted fiber installations initially required the attachment of a parachute onto the end of a fiber cable with low pressure air pushing the parachute, thereby pulling the cable through the a conduit. The idea of blowing individual fibers and/or bundles came about by accident.

While performing an air assisted installation the parachute that was attached to the fiber came off the end of the cable and blew out the end of the conduit. This had happened many times but this time, instead of shutting down the compressor, the technicians left it running. While they discussed how to better secure the parachute to the end of the cable. To their amazement a few minutes later, out came the fiber. The technicians went to the engineers for an explanation of how this could happen.

Experimentation discovered that a principle of fluid mechanics that states “molecules will travel slower through the center axis of a tube as compared to molecules nearer the outside wall of the tube due to the friction that the molecules exert on each other close to the center.” The molecules traveling faster along the walls create a high pressure zone at the tube wall. This has the effect of forcing the coated fiber to the center of the tube. The air removes the friction and the fibers ride the blanket of air through the tube. It has been demonstrated that the fiber will pass up to 300 ninety degree bend in a proper installation.

The tubes in the BOF cables are made of a low smoke zero halogen material. The fibers in the tubes are terminated within the fiber optic interconnection box (FIB) utilizing a furcation unit. A furcation unit (called a breakout kit in the commercial sector) is used to increase the fiber diameter to 900um thereby providing additional mechanical protection and the ability to terminate to a type ST connector. Proper installation of this furcation unit with connector also serves to provide compliance for watertight integrity of the tubes.

Tubes serve as the pathway for the fibers. Cables are available in tube counts of 1, 7 & 19. The tubes provide the route that the fiber is blown into using low pressure compressed air. The ability to provide a splice free point-to-point path is one of the key advantages of BOF. After the tube cables are installed, individual fiber strands containing single mode or 62.5 multimode fibers are blown in. These fibers can be blown in at speeds of up to 40 meters per minute. The maximum distance a group of 8 fibers can be

blown is 3280' horizontally or 1000' vertically. This is more than sufficient to meet the requirements for shipboard applications.

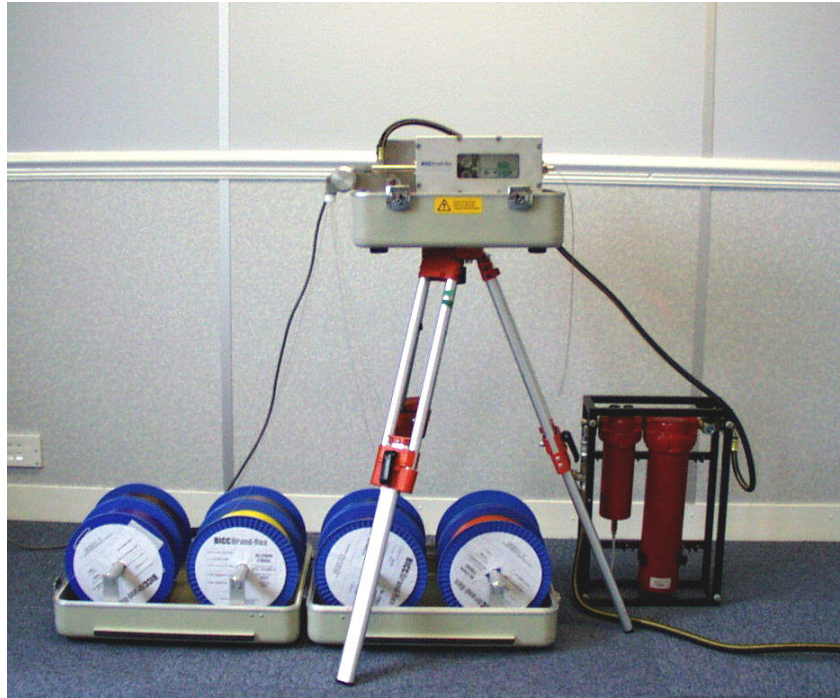

Figure 3-18. - BOF Installation Equipment

BOF technology is based upon blowing individual or bundled fibers simultaneously. To facilitate the blowing process, an additional acrylate type coating is applied to standard qualified fibers (QPL). This additional coating provides color identification for the individual fibers with a textured surface. The colored coating facilitates viscous drag that assists the installation process by providing a textured surface for the air being blown into the tube to “grab” the fiber and carry it through the tube. This allows the fibers to be carried with the air flow in a stress free environment theoretically in the center of the tube during the installation process. See Figure 3-18. A tractor feed is used to remove the fibers from the payoff reels/spools and feed them through the blow head and into the tube for a few feet until viscous drag is sufficient to pick up the fibers and carry them through the tubes.

The most interesting application for BOF is on board US Navy Ships. On November 5, 1997 the first fibers were blown into a fiber optic cable plant on the USS Truman (CVN-75). A 600 foot tube route was populated with four individual strand of fiber in approximately 5 minutes. BOF was installed as the backbone for the ships communications, navigation, monitoring, and LAN fiber plant.

Newport News Shipbuilding was instrumental in the development of the concept of installing fiber optics on board ships utilizing BOF technology. The process consists of installing cables containing empty tubes throughout the ship. A multi-duct or multi-tube cable consists of seven tubes/microducts covered with an outer thermoset jacket. The tubes are configured to support any fiber run within the cable plant. The tubes are

connected to each other within a tube routing box (TRB), see figure 3-19, through the use of push fit pneumatic connectors. This permits a fiber route from any one point to another to be continuous. The result is no need for fiber splicing or fiber connections end-to-end.

The transition to conventional fiber cable is accomplished through fiber optic interconnection boxes (FIB) via a furcation unit. Conventional cable is routed from the FIB to the end device. Some applications have a single BOF tube cable connected to the end device with a multi-terminus connector or a single tube cable is used to blow fiber directly to the equipment rack. Once in the equipment rack the fibers are now routed to a splice tray and fusion spliced to a pigtail that is connected to the edge switch or network card.

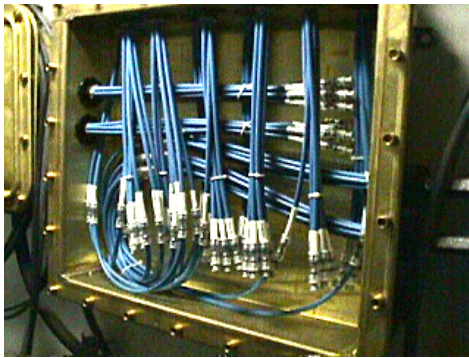

Tube Routing Box (TRB)

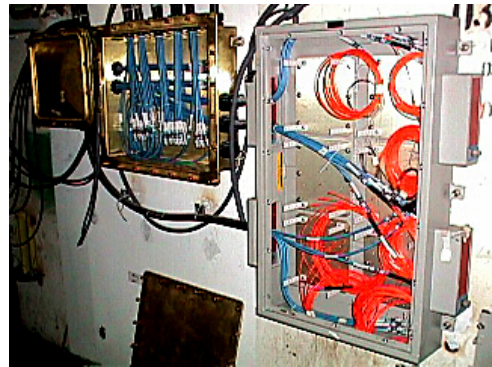

TRB and Fiber Optic Interconnection Box (FIB)

Figure 3-19. - BOF Tube Routing and Interconnection Boxes

The installation of BOF on US Navy ships is now a routine part of new ship construction and modernization. Each aircraft carrier in the fleet has over one million feet of BOF fibers installed. BOF is now being installed on Virginia class submarines, LPDs, LHDs, Destroyers and Cruisers.

A-33. What is the maximum blowing distance for Blown Optical Fiber?

A-34. When was the first Blown Optical Fiber blown on a US Navy ship?

SUMMARY

Now that you have completed this chapter, let's review some of the new terms, concepts, and ideas that you have learned. You should have a thorough understanding of these principles before moving on to chapter 4.

OPTICAL FIBER CLASSIFICATION depends on more than the number of modes that a fiber can propagate. The optical fiber's refractive index profile and core size further distinguish different types of single mode and multimode fibers.

The **REFRACTIVE INDEX PROFILE** describes the value of the fiber's refractive index as a function of axial distance at any fiber diameter.

In **STEP-INDEX** fibers, the refractive index of the core is uniform and undergoes an abrupt change at the core-cladding boundary.

In **GRADED-INDEX** fibers, the refractive index of the core varies gradually as a function of radial distance from the fiber center.

MULTIMODE STEP-INDEX FIBERS have relatively large core diameters and large numerical apertures. Unfortunately, multimode step-index fibers have limited bandwidth capabilities and poor bend performance. Short-haul, limited bandwidth, low-cost applications use multimode step-index fibers.

MULTIMODE GRADED-INDEX FIBERS have a core where the refractive index of the core (n) varies. With the densest layer at the center axis (n_1) and the value of n decreases until it approaches the value of the refractive index of the cladding (n_2). Like the step-index fiber, the value of n_2 is constant and has a slightly lower refractive index than n_1 .

The gradual decrease in the core's refractive index from the center of the fiber causes propagating modes to be refracted many times.

Multimode graded-index fibers have less **MODAL DISPERSION** than multimode step-index fibers. Lower modal dispersion means that multimode graded-index fibers have higher bandwidth capabilities than multimode step-index fibers.

SOURCE-TO-FIBER COUPLING EFFICIENCY and **INSENSITIVITY TO MICROBENDING AND MACROBENDING LOSSES** are distinguishing characteristics of multimode graded-index fibers. 62.5 μm fibers offer the best overall performance for multimode graded-index fibers.

MATCHED-CLAD and **DEPRESSED-CLAD** are two types of single mode step-index fibers. Matched cladding means that the fiber cladding is a single homogeneous layer of dielectric material. Depressed cladding means that the fiber cladding consists of two regions: an inner and outer cladding region.

SINGLE MODE FIBER CUTOFF WAVELENGTH is the smallest operating wavelength where single mode fibers propagate only the fundamental mode. At this wavelength, the 2nd-order mode becomes lossy and radiates out of the fiber core.

SINGLE MODE FIBERS have low attenuation and high-bandwidth properties. Present applications for single mode fibers include long-haul, high-speed telecommunication systems.

VAPOR PHASE OXIDATION and **DIRECT-MELT PROCESS** are two methods of fabricating multimode and single mode optical fibers.

CABLE STRUCTURES include buffers, strength members, and the jacket, or sheath.

TIGHT-BUFFERED, LOOSE-TUBE, and **GEL-FILLED LOOSE-TUBE** are types of fiber optic buffering techniques.

FIBER OPTIC CABLES use strength members to increase the cable's strength and protect the optical fibers from strain.

JACKET MATERIAL should have low smoke generation, low toxicity, low-halogen content, flame retardance, fluid resistance, high abrasion resistance, and stable performance over temperature.

ANSWERS TO QUESTIONS Q1. THROUGH Q34.

- A1. *Refractive index profile describes the value of refractive index as a function of radial distance at any fiber diameter.*
- A2. *Step-index.*
- A3. *Multimode graded-index fiber.*
- A4. *Multimode step-index fibers: 50 μm and 100 μm . Multimode graded-index fibers: 50 μm , 62.5 μm , 85 μm , and 100 μm . Single mode fibers: between 8 μm and 10 μm .*
- A5. *Cladding.*
- A6. *Most modes in multimode step-index fibers propagate far from cutoff.*
- A7. *Make it easier to couple light from a light-emitting diode (LED) into the fiber.*
- A8. *A multimode graded-index fiber has a core made of hundreds of layers with the layer most dense layer exactly in the center of the core. As the layers extend out from the center each subsequent layer is slightly less dense than the layer within it.*
- A9. *When the angle of incidence becomes larger than the critical angle of incidence.*
- A10. *At least 20 μm thick.*
- A11. *In Local Area Networks (LANs) less than two kilometers in length.*
- A12. *62.5/125 μm multimode graded-index fiber.*
- A13. *Source-to-fiber coupling efficiency and insensitivity to microbending and macrobending losses.*
- A14. *Matched-clad and Depressed-clad.*
- A15. *Depressed.*
- A16. *The fundamental mode becomes increasingly lossy.*

- A17. *To increase performance.*
- A18. *High NA, low bandwidth, tight bend radius, short length, and low cost.*
- A19. *Heavy-metal fluorides, Chalcogenide glasses, and crystalline materials.*
- A20. *Thermoset cables are chemically bonded and radiated. Thermoplastic are preheated.*
- A21. *Vapor phase oxidation and direct-melt process.*
- A22. *Vapor phase oxidation.*
- A23. *a. Protect optical fibers from damage or breakage during installation and over the fiber's lifetime.*
- b. Provide stable fiber transmission characteristics compared with uncabled fibers.*
- c. Maintain the physical integrity of the optical fiber.*
- A24. *To provide additional mechanical protection and preserve the fiber's inherent strength.*
- A25. *Tight-buffered, loose-tube, and gel-filled loose-tube.*
- A26. *Low smoke generation, low toxicity, low halogen content, flame retardance, fluid resistance, high abrasion resistance, and stable performance over temperature.*
- A27. *Tight buffered breakout.*
- A28. *OFCCs are tight-buffer fiber surrounded by aramid yarn and a low-halogen outer jacket.*
- A29. *To minimize microbending of the fibers.*
- A30. *To minimize fiber stress when the cable is bent.*
- A31. *OFCC (12 fibers), distribution (48 fibers), ribbon (204 fibers).*
- A32. *Ribbon.*
- A33. *3280 feet horizontally and 1000 feet vertically.*
- A-34. *November 5, 1997.*

CHAPTER 4

FIBER OPTIC CONNECTIONS, SPlicing AND COUPLERS

LEARNING OBJECTIVES

After you finish this chapter, you should be able to do the following:

1. Understand the inspection and cleaning process.
2. List the types of extrinsic and intrinsic losses.
3. Understand the degree to which fiber alignment and fiber mismatch problems increase extrinsic loss.
4. Detail the cleaving process for fiber- preparation.
5. Identify the types of fiber optic mechanical and fusion splices. Outline the basic splicing techniques for each type of fiber optic splice.
6. List the types of fiber optic connectors. Detail the procedure for terminating a fiber optic connector on an optical fiber.
7. Discuss the types of fiber optic passive couplers.

FIBER OPTIC CONNECTIONS

Chapter 1 states that a fiber optic data link performs three basic functions. First, the data link transmitter converts an electrical input signal to an optical signal. Then, the optical fiber carries the optical signal to its destination point. Finally, the receiver converts the optical pulses back to an electrical signal identical to the original input. However, chapter 1 does not describe how optical power transitions through optical connections.

This chapter describes how the optical fiber cable plant is linked together. Starting with how the connector end faces are inspected and cleaned before making a connection. You will learn what types of losses are incurred in the cable plant and at the connection points. Also, this chapter will cover the types of connectors that are used, where they are used and how they are terminated. It also discusses the basics of fusion and mechanical splicing and how they differ from connectors.

A system connection may require either a fiber optic splice, connector, or coupler. One type of system connection is a permanent connection made by splicing optical fibers

together. A fiber optic **splice** makes a permanent joint between two fibers or two groups of fibers. There are two types of fiber optic splices--mechanical splices and fusion splices. Even though removal of some mechanical splices is possible, they are intended to be permanent. Another type of connection that allows for system reconfiguration is a fiber optic **connector**. Fiber optic connectors permit easy coupling and uncoupling of optical fibers. Fiber optic connectors sometimes resemble familiar electrical plugs and sockets. Systems may also divide or combine optical signals between fibers. Fiber optic **couplers** distribute or combine optical signals between fibers. Couplers can distribute an optical signal from a single fiber into several fibers. Couplers may also combine optical signals from several fibers into one fiber.

In a fiber optic cable plant, minimizing loss at connection points is critical to system performance. Every connection in the plant is a possible point of failure. Extreme care must be taken when terminating and connecting the connectors. Understanding the proper building methods, what makes a quality end face, proper cleaning processes, and testing methodologies are important to the long term reliability of the fiber optic cable plant.

INSPECTION AND CLEANING

Fiber optic connection losses may affect system performance. The number one problem in maintaining a cable plant is contamination. A single contaminate particle mated in the core of an optical fiber can cause significant back reflection, insertion loss and even equipment damage. The average dust particle is 2 to 5 microns in diameter (.000002 to .000005um), which is not visible to the human eye. The typical filter size used in HVAC systems both commercially (in buildings) and onboard naval vessels is 5 microns. Most dust particles flow right through them. That is why you still have to dust your house! The filters were not designed to remove dust, just the big stuff. It would be like expecting a screen door to keep out the wind. Standard filters are not designed with optics in mind. See Figure 4-1 below.

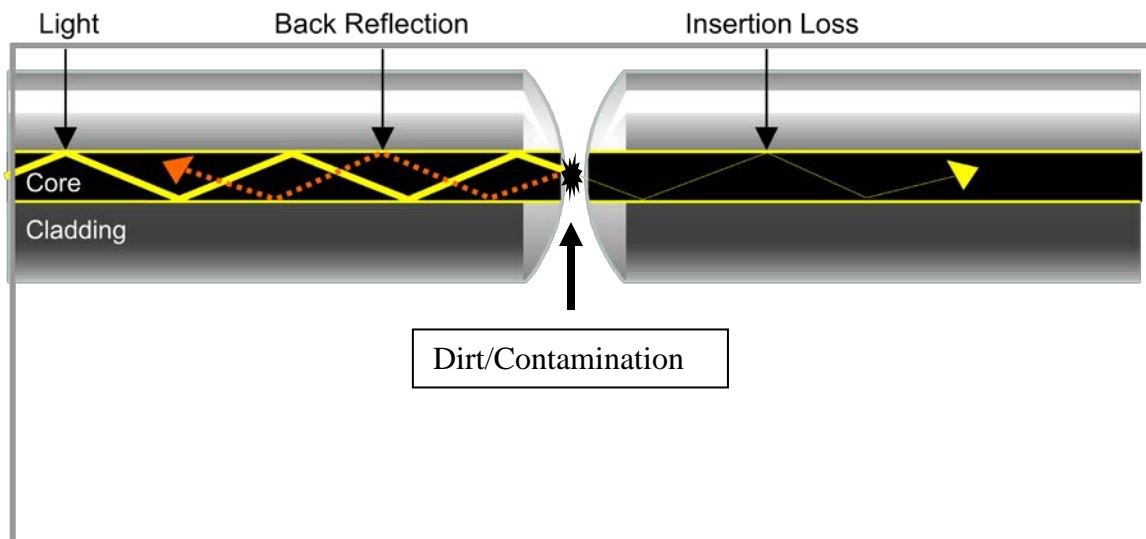

Figure 4-1. - Connector Contamination

Therefore, a 4 micron dust particle sitting on the core of an 8 micron single mode fiber has the potential to create at least a 50 percent loss of power in the system. If a class 3a Laser is the light source, it has enough power to burn the dust particle into the glass core causing permanent damage. Also, if it is a single mode system, the back reflection caused by this particle can create bit errors and lower system performance to the point where the Laser will shut itself down in order to protect itself. Good cleaning processes are critical to system performance.

Before any optical connection is made you should inspect the end face using at least a 200X microscope (the Navy requires a 400X microscope) before mating the connector up. Also, since a dust particle has a negative charge and the glass and ferrule on the end face are dielectrics, the dust particle is attracted to the end face of the connector. Once the dust particle makes contact with the end face an ionic bond is made. In order to break the ionic bond a fiber optic preparation fluid with static dissipating properties should be used to clean the end face.

Cross contamination is also a major problem. If one side of the connection is dirty and is connected to a clean end face. The dirty one will cross contaminate the clean end face. That means you have to clean both end faces of the connectors being mated together before the connection can be made.

Microscopes are used to inspect single terminus connectors in the cable plant. Video inspection probes are used when inspecting multi-terminus connectors or at the ports of the electronics. See Figure 4-2 below. Every time a connection is disconnected or separated the end faces have to be inspected and cleaned prior to hooking them back together. See Figure 4-3.



Figure 4-2. - Video Inspection Probe

Follow this simple “INSPECT BEFORE YOU CONNECT” process to ensure fiber end faces are clean prior to mating connectors.

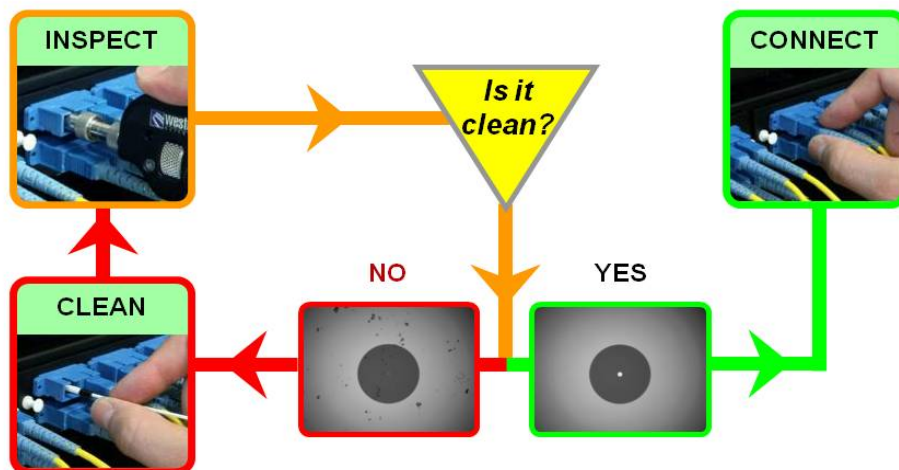

Figure 4-3. - Inspect and Clean Process

Q1. What is the number one problem in maintaining a fiber optic cable plant?

Q2. What magnification of microscope does the Navy require?

Q3. What type of inspection equipment is used to view multiple terminus connectors?

TYPES OF OPTICAL FIBER LOSS

Ideally, optical signals coupled between fiber optic components are transmitted with no loss of light. However, there is always some type of imperfection present at fiber optic connections that causes some loss of light. Minimizing that loss is very important to system operation and performance.

Where does the loss come from in the fiber optic cable plant? It is the sum of three components; 1) cable loss 2) connector loss and 3) splice loss. The cable loss is set by industry standards at 3.5dB/km @ 850nm and 1.5dB/km@1300 nm for multimode fiber. Single mode fiber is 1dB @ 1310nm, 1550nm and 1625nm for indoor cable and @ 0.5dB/km for outdoor cable at all three single mode wavelengths.

Cable loss for the Navy is different from commercial standards due to the fire retardant process that those cables are required to have. They are 4.5dB/km @ 850nm and 2.0dB/km @ 1300 for multi-mode cables and 1.5dB/km @ 1310nm and 1550nm for single mode.

Insertion loss for all connectors is 0.75dB per mated pair and commercial splice loss is 0.3dB for both mechanical and fusion splices. Splice losses in the Navy are set at 0.2dB for fusion and mechanical splices. The sum of these losses (cable, splice, and connector) is called the Maximum Allowable Loss or MAL. The MAL determines the pass/fail criteria of the fiber optic cable plant and the links that make it up.

Let's review some properties first discussed in chapter 2. **Intrinsic losses** are caused by the manufacturing process and are inherent in the glass. **Extrinsic losses** are caused by external forces being applied to the cables and connections.

Intrinsic Attenuation

Intrinsic attenuation results from materials inherent to the fiber and from the manufacturing process. As precise as manufacturing is, there is no way to eliminate all impurities. When a light signal hits an impurity in the fiber, one of two things occurs: It scatters or it is absorbed. Intrinsic loss can be further characterized by two components:

- Material absorption
- Rayleigh scattering

Material Absorption

Material absorption occurs as a result of the imperfection and impurities in the fiber. The most common impurity is the **hydroxyl (OH-) molecule**, which remains as a residue despite stringent manufacturing techniques.

Attenuation Versus Wavelength

The OH- symbols indicate that at the 950nm, 1380nm, and 2730nm wavelengths, the presence of hydroxyl radicals in the cable material causes an increase in attenuation. These radicals result from the presence of water remnants that enter the fiber-optic cable material through either a chemical reaction in the manufacturing process or as humidity in the environment. The variation of attenuation with wavelength due to the water peak for standard, single-mode fiber-optic cable occurs mainly around 1380 nm.

Absorption

Absorption accounts for three percent to five percent of fiber attenuation. This phenomenon causes a light signal to be absorbed by natural impurities in the glass and converted to vibration energy or some other form of energy such as heat. Unlike scattering, absorption can be limited by controlling the amount of impurities during the manufacturing process. Because most fiber is extremely pure, the fiber does not heat up because of absorption.

Rayleigh Scattering

As light travels in the core, it interacts with the silica molecules in the core. Rayleigh scattering is the result of these collisions between the light wave and the silica molecules in the fiber. Rayleigh scattering accounts for about 96 percent of attenuation in optical fiber. If the scattered light maintains an angle that supports forward travel within the core, no attenuation occurs. If the light is scattered at an angle that does not support continued forward travel, however, the light is diverted out of the core and attenuation occurs. Depending on the incident angle, some portion of the light propagates forward and the other part deviates out of the propagation path and escapes from the fiber core. Some scattered light is reflected back toward the light source. This is a property that is used in an **Optical Time Domain Reflectometer (OTDR)** to test fibers. The same principle applies to analyzing loss associated with localized events in the fiber, such as splices.

Short wavelengths are scattered more than longer wavelengths. Any wavelength that is below 800 nm is unusable for optical communication because attenuation due to Rayleigh scattering is high. At the same time, propagation above 1700 nm is not possible due to high losses resulting from infrared absorption.

Extrinsic Attenuation

Extrinsic attenuation can be caused by two external mechanisms: macro bending or micro bending. Both cause a reduction of optical power. If a bend is imposed on an optical fiber, strain is placed on the fiber along the region that is bent. The bending strain affects the refractive index and the critical angle of the light ray in that specific area. As a result, light traveling in the core can refract out, and loss occurs.

A macro bend is a large-scale bend that is visible, and the loss is generally reversible after bends are corrected. See Figure 4-4. To prevent macro bends, all optical fiber has a minimum bend radius specification that should not be exceeded. This is a restriction on how much bend a fiber can withstand before experiencing problems in optical performance or mechanical reliability. Longer wavelengths are more susceptible to bending losses

The second extrinsic cause of attenuation is a micro bend. Micro bending is caused by imperfections in the cylindrical geometry of fiber during the manufacturing process. Micro bending might be related to temperature, tensile stress, or crushing force. Like macro bending, micro bending causes a reduction of optical power in the glass.

Optical fibers would not be practical transmission media if their ability to guide light required them to be kept perfectly straight. It must be realized that any deviation from perfect straightness causes some light to scatter into the cladding and be lost. Such deviations can occur in two ways; via large bends that can be seen by the human eye, called macro bends, and by microscopically small deviations in the fiber axis, called micro bends. See Figure 4-4.

Attenuation varies with the wavelength of light. Windows are low-loss regions, where fibers carry light with little attenuation. Refer back to Chapter 1. The first generation of optical fibers operated in the first window around 820nm to 850nm. The second window is the zero dispersion region of 1300m, and the third window is the 1550nm region.

The decibel is the unit of measurement used in optics to describe loss. A decibel is a ratio of the output power compared to the input power. 3dB is considered the half power ratio. For example; a transmitter has an output of 10 watts of power and it feeds that power into a link where a 3dB loss is incurred in the cable plant. The amount of power available at the receiver is now 5 watts. 3dB = a 50% power loss or half the power. If the loss in the plant increased to 10dB the amount of power now available at the receiver would be 1 watt or a 90 percent drop of power. From this brief example it should be obvious that minimizing loss in the cable plant is extremely important to the performance and reliability of the network.

One important feature of attenuation in an optical fiber is that it is constant at all modulation frequencies within the bandwidth. In copper cables, attenuation increases with the frequency of the signal; the higher the frequency the higher the attenuation. As a result, signal frequency limits the distance a signal can be sent before a repeater is needed to regenerate the signal.

Bending Loss

For bending radii larger than a couple of inches, macro bending losses are small and imperceptible. For bending radii less than a few inches, loss increases rapidly and becomes prohibitively large at a certain critical radii.

Micro bends can cause high-order modes to reflect at angles that will not allow further reflection. The light is lost. Micro bends can occur during the manufacture of the fiber or can be caused by the technician. Manufacturing and cabling techniques have advanced to minimize micro bends and their effects. Micro bends are typically caused by the technicians installing the cables. Cable bands and wire ties being cinched down too tightly are the primary problem areas.

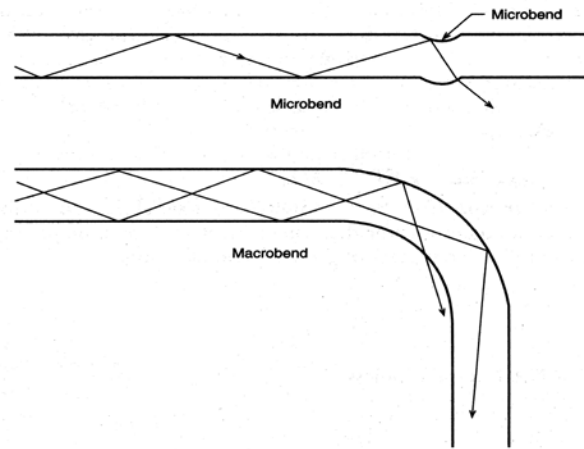

Figure 4-4. - Loss and Bends

Q4. Where does loss come from in a fiber optic cable plant?

Q5. What factors cause intrinsic and extrinsic losses?

Q6. What unit of measurement is loss expressed in fiber optics?

Fiber Alignment

A main source of extrinsic loss in fiber connections is poor fiber alignment. The three basic coupling errors that occur at connection points are fiber separation (longitudinal misalignment), lateral misalignment, and angular misalignment. Most alignment errors are the result of mechanical imperfections introduced by fiber jointing techniques. However, alignment errors do result from installers not following proper connection procedures.

With **fiber separation**, a small air gap remains between fiber-end faces after completing the fiber connection. Figure 4-5 illustrates this separation of the fiber-end faces.

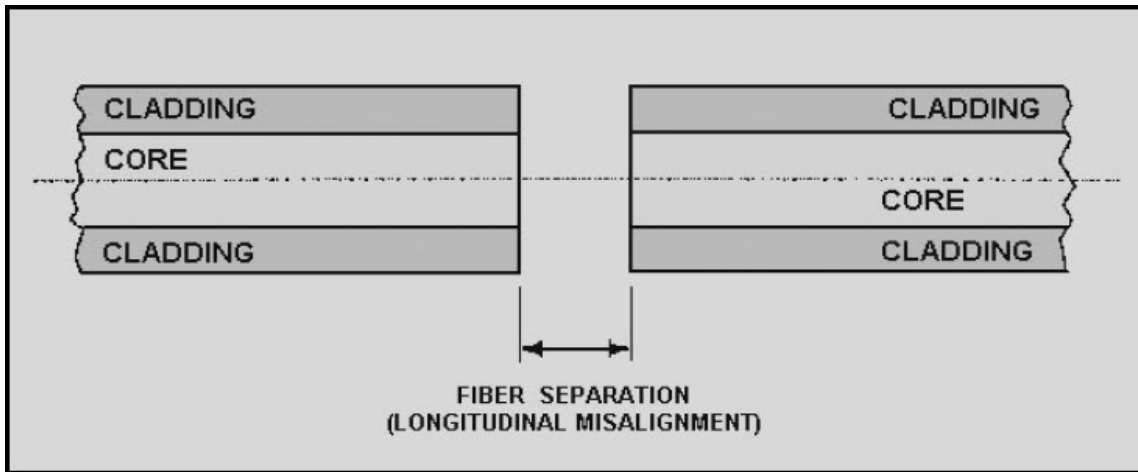

Figure 4-5. - End Separation

Lateral, or axial, misalignment occurs when the axes of the two fibers are offset in a perpendicular direction. Figure 4-6 shows this perpendicular offset of the axes of two connecting fibers.

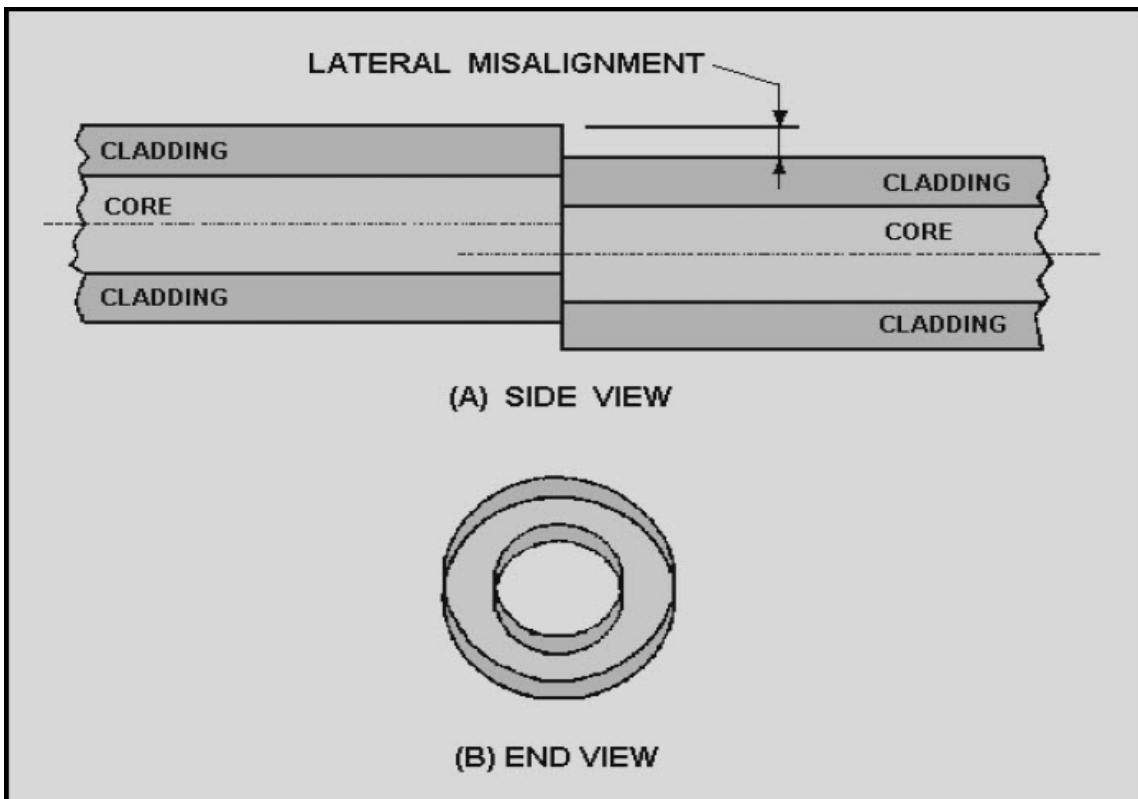

Figure 4-6. - Lateral Misalignment

Angular misalignment occurs when the axes of two connected fibers are no longer parallel. The axes of each fiber intersect at some angle (θ). Figure 4-7 illustrates the angular misalignment between the core axes.

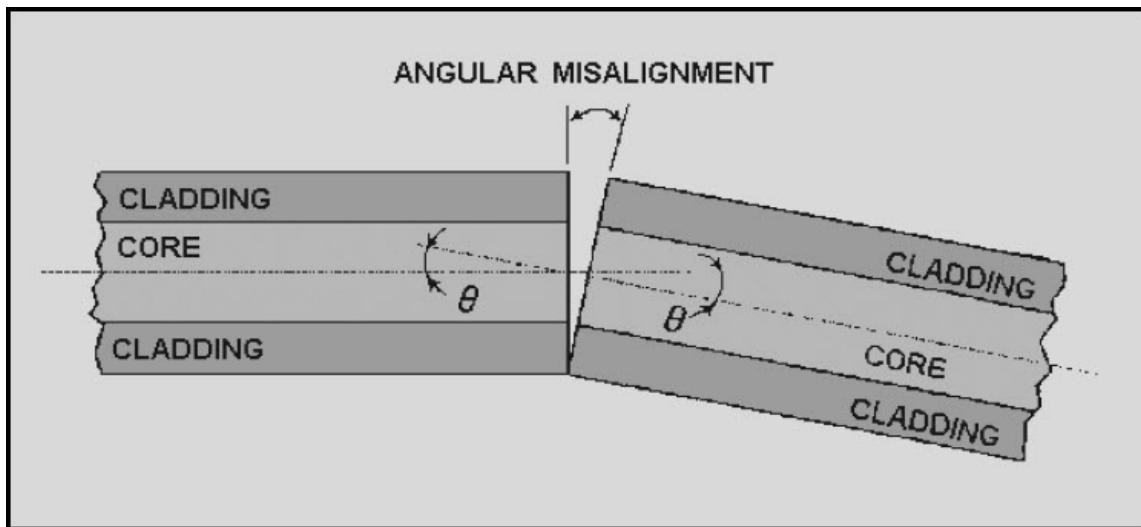

Figure 4-7. - Angular Misalignment

Loss caused by lateral and angular misalignment typically is greater than the loss caused by fiber separation. Loss, caused by fiber separation, is less critical because of the relative ease in limiting the distance of fiber separation. However, in some cases, fiber optic connectors prevent fibers from actual contact. These fiber optic connectors separate the fibers by a small air gap. This air gap eliminates damage to fiber-end faces during connection and in high vibration applications

Most connectors are designed so that the connector ferrule end faces contact when the connector is mated. These are called Physical Contact (PC) connectors. The physical contact (PC) polish technique was developed for most connectors so that the fibers would touch when mated and lower insertion loss and back reflection.

Losses due to fiber alignment depend on fiber type, core diameter, and the distribution of optical power among propagating modes. Fibers with large NAs reduce loss from angular misalignment and increase loss from fiber separation. Single mode fibers are more sensitive to alignment errors than multimode fibers because of their small core size. However, alignment errors in multimode fiber connections may disturb the distribution of optical power in the propagating modes, increasing coupling loss.

Q7. List the three basic errors that occur during fiber alignment.

Q8. When the axes of two connected fibers are no longer in parallel, the two connected fibers are in what kind of misalignment?

Q9. What does PC stand for?

Q10. Which are more sensitive to alignment errors, single mode or multimode fibers?

FIBER END PREPARATION

Fiber-end preparation begins by removing the fiber buffer and coating material from the end of the optical fiber. Removal of these materials involves the use of mechanical strippers or chemical solvents. When using chemical solvents, the removal process must be performed in a well-ventilated area. For this reason mechanical strippers are used for buffer and coating removal in the shipboard environment. After removing the buffer and coating material, the surface of the bare fiber is wiped clean using a wiping tissue. The wiping tissue must be wet with isopropyl alcohol before wiping.

The next step in fiber-end preparation involves cleaving the fiber end to produce a smooth, flat fiber end face. The **score-and- cleave**, or scribe-and-cleave, method is the basic fiber cleaving technique for preparing optical fibers for termination. The score-and-cleave method consists of lightly scoring (scratching) the outer surface of the optical fiber and then pulling the glass straight off. A carbide or diamond blade is used to score the glass. See Figure 4-8.



Figure 4-8. - Hand Held Fiber Cleaver

Q11. What buffer stripping method is used on naval ships?

Q12. What is the basic fiber cleaving technique for preparing optical fibers for termination?

FIBER MISMATCHES

Fiber mismatches are a source of intrinsic loss. As stated before, intrinsic loss results from inherent fiber characteristics of the two connecting fibers. Fiber mismatches occur when manufacturers fail to maintain optical or structural (geometrical) tolerances during fiber fabrication.

Types of fiber mismatches include fiber geometry mismatches, NA mismatch, and refractive index profile difference. Fiber geometry mismatches include core diameter, cladding diameter, core ellipticity, and core-cladding concentricity differences. Figure 4-9 illustrates each type of optical and geometrical fiber mismatch. Navy fiber specifications tightly specify these parameters to minimize coupling losses from fiber mismatches.

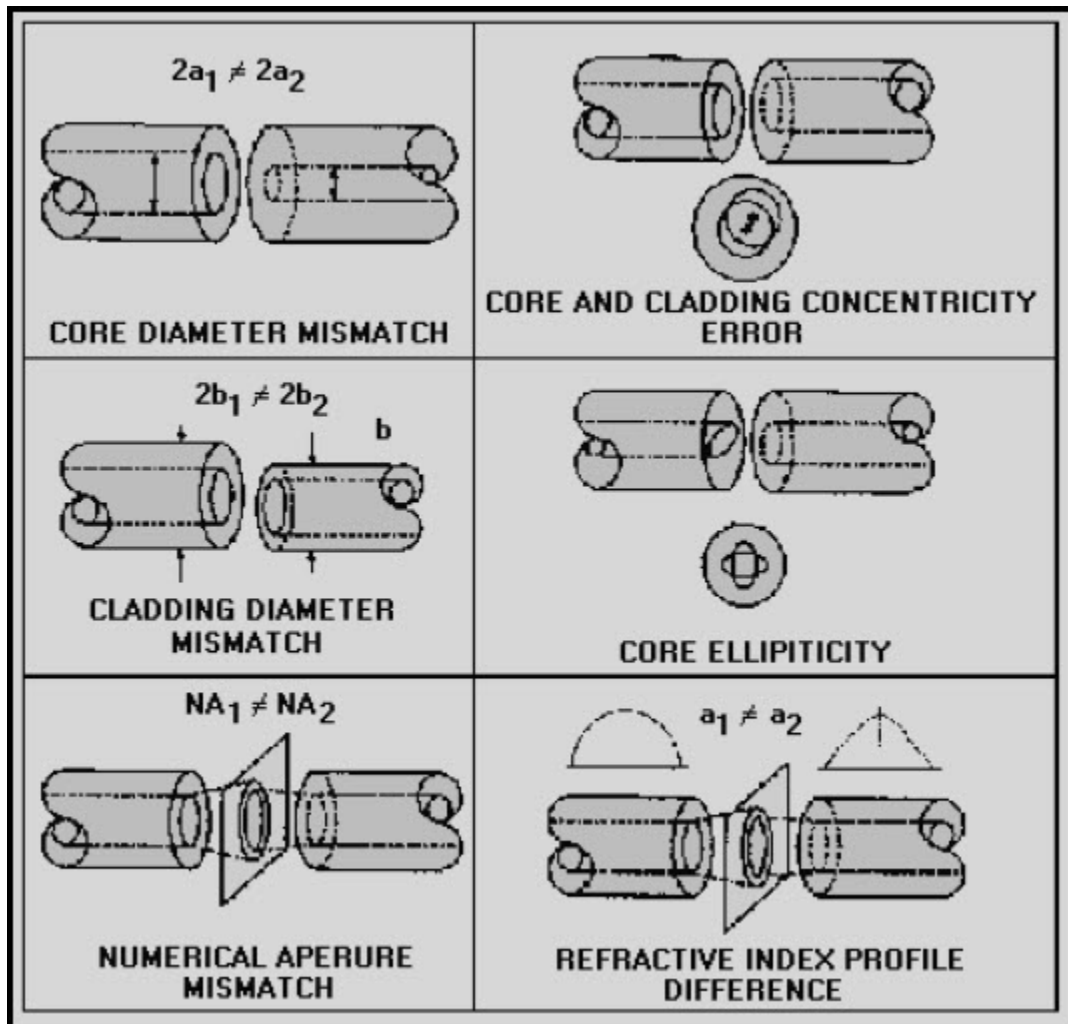

Figure 4-9. - Types of optical and geometrical fiber mismatches that cause intrinsic loss.

Core diameter and NA mismatch have a greater effect on intrinsic loss than the other types of fiber mismatches. In multimode fiber connections, the loss resulting from core diameter mismatch, NA mismatch, and refractive index profile difference depends on the characteristics of the launching fiber. Loss from **core diameter mismatch** results only if the launching fiber has a larger core radius (a) than the receiving fiber. Loss from **NA mismatch** results only if the launching fiber has a higher NA than the receiving fiber. Loss from **refractive index profile difference** results only if the launching fiber has a larger profile parameter (α) than the receiving fiber.

Q13. List six types of fiber mismatches.

Q14. Does loss from refractive index profile difference result when the receiving fiber has a larger profile parameter (α) than the transmitting fiber?

FIBER OPTIC SPLICES

History of Fusion Splicing

Much of the fundamental research concerning fusion splicing was conducted in the 1970's. The first documented optical fiber fusion splices were performed by Dan L. Bisbee at Bell Laboratories. Bisbee proposed numerous techniques that are now standard practice in optical fiber fusion splicing: Proper preparation of fiber ends, obtaining planar end faces, and utilization of mirrors to permit orthogonal views of fiber end faces.

Initial optical losses of pioneering multimode fusion splices were measured to be as low as 0.5dB. Researchers in the UK performed the first fusion splice of single-mode fibers. This group recognized the extreme importance of fiber alignment for achieving low-loss single mode fibers.

In 1973, Bell Labs documented the first optical fiber cleaver designed to take advantage of brittle fracture to obtain extremely flat fiber end faces. With this utility, losses as low as 0.04 dB were achieved with multimode fibers. Initially, fusion splicing used nichrome wire as the heating element to melt or fuse fibers together. However in 1976, researchers at Hitachi in Japan turned to carbon dioxide (CO₂) lasers. At the same time, researchers at Corning Inc. suggested the use of an electric arc discharge to splice silica fibers.

Bisbee documented multimode fiber splice losses as low as 0.03 dB with the electric arc discharge technique. The first mass fusion splices of optical fiber ribbon cable was performed with a CO₂ laser by Kinoshita and Kobayashi in 1979. However the splices could only be spliced one at a time. In 1981, Tachikura followed the lead of Kohanzadeh by simultaneously splicing five multimode fibers with an electric arc. In 1985, Krause and Kurkjian of Bell Labs reported fabricating single-mode fiber splices whose failure strengths were just as good as the unspliced fiber. During the 1980's and 1990's, a variety of commercial fusion splicing equipment was introduced (electric heat source splicers) and a wide variety of specialty fibers was introduced (erbium-doped gain fiber, dispersion -compensating fiber, etc.).

Today, fusion splicers can splice single fibers or up to 24 fiber count ribbon fibers at the same time. The small size of the fusion splice and the development of automated fusion-splicing machines have made electric arc fusion one of the most popular splicing techniques in commercial applications. The splices offer sophisticated, computer -controlled alignment of optical fibers to achieve low optical losses (0.02 dB).

Basics of Fusion Splicing

An optical fiber splice is a permanent fiber joint whose purpose is to establish an optical connection between two individual optical fibers. Connecting two optical fibers requires precise alignment of the mated fiber. This is required so that nearly all the light is coupled from one optical fiber across a junction to the other optical fiber.

Fusion splicing is performed with a specialized instrument (splicer) to fuse the fibers together. Fusion splicers use an electric arc to weld two optical fibers together. The process of fusion splicing involves using localized heat to melt or fuse the ends of two optical fibers together. The splicing process begins by preparing each fiber end for fusion. Fusion splicing requires that all protective coatings be removed from the ends of each fiber. The fiber is then cleaved (cut) with a precision cleaver to make it perpendicular.

The fibers are then placed into special holders (some splicing systems use removable holders, so fiber can be loaded into the holders and then fiber preparation commences) in the splicer. The splice is usually inspected via a magnified viewing screen to check the fiber end cleaves before and after the splice. The splicer uses small motors to align the end faces together, and emits a small spark between electrodes at the gap to burn off dust and moisture.

Then the splicer generates a larger spark that raises the temperature above the melting point of the glass, fusing the ends together permanently. The location and energy of the spark is carefully controlled so that the molten core and cladding don't mix, and this minimizes optical loss.

Finally, the splice loss is estimated by the splicer. Common techniques for loss estimation are: directing light through the cladding on one side and measuring the light leaking from the cladding on the other side or by taking measurements of the physical properties of the completed splice from the fiber image and using an algorithm to determine splice loss.

Purpose of Fusion Splicing

Since the purpose of using fiber as a transmission medium is to transmit light, the fiber joint must transmit as much light power as possible with as little loss and back reflection as can be designed into the joint. Generally, fiber connections fall into two categories: the permanent or fixed joint (using a splice), and the non-fixed joint (using a connector).

Splices offer a lower return loss, lower attenuation, and are physically stronger than connectors. They're usually less expensive, require less labor, constitute a smaller joint for inclusion into splice closures, offer a better hermetic seal, and allow either individual or mass splicing. Splicing usually occurs in the middle of a long distance cable or where a permanent connection is required.

Fusion splicing uses an electric arc to ionize the space between prepared fibers to eliminate air and heat the fibers to proper temperature (2,000C). The electrodes should be replaced on the typical splicer every 1000 arcs. The fibers then feed in as semi-liquids and meld together. A plastic sleeve with a strength member is used as a protective device that replaces the previously removed plastic coating. This process generally requires a controlled environment, such as a splicing van or trailer, to reduce the possibility of dust and other contamination.

Due to the "welding" process, it's sometimes necessary to modify the fusion parameters to suit particular types of fibers, especially if you have to fuse two different fibers (from two different manufacturers or with different core/cladding structures).

Fusion splicers are easily used with multimode fiber but single mode fiber adds a degree of difficulty due to the small size of the core. With multimode fibers, it is sufficient to align the claddings to achieve a low splice loss. Single mode fibers, however, demand that the cores be aligned. Achieving the best fusion is a complex matter involving not only precise alignment of fibers, but careful application of the correct arc discharge power and timing. An incorrect discharge, for example, can deform the cores. Splicers have adjustable power and time to accommodate different fibers and application needs.

The earliest splicers required a great degree of operator skill to align the fibers, often visually through a microscope. Often power through the fibers was measured as the fibers were being aligned. At the point of maximum power at the junction, the fibers were locked in place and fused. Such power monitoring could be done remotely with an OTDR or locally by techniques that injected a small amount of light into cladding at a bend in the fiber. Micropositioners hold the fibers and allow them to be precisely aligned three dimensionally along the x, y, and z axes, either manually or automatically.

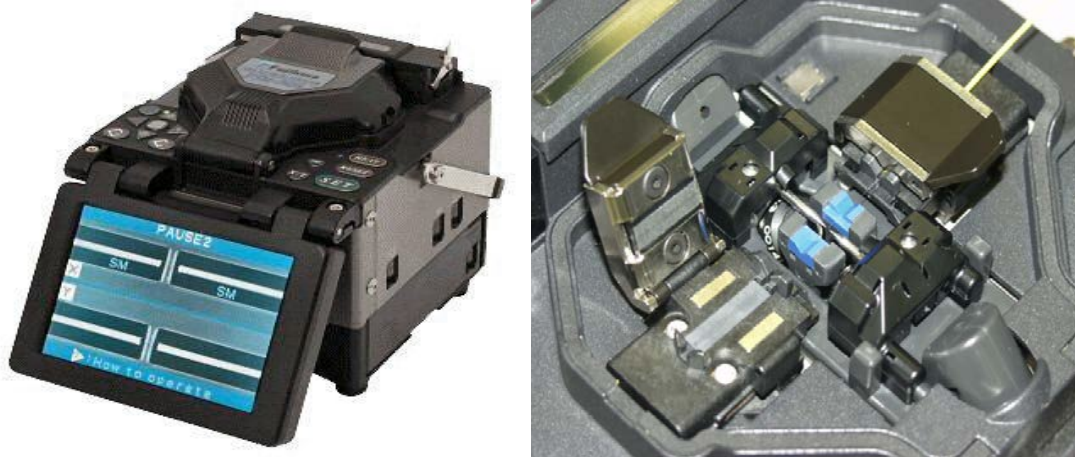

Figure 4-10. - Fusion Splicer

Today's splicers have a high degree of computer control and analysis to automate the fusion process. See Figure 4-10. The profile alignment system uses collimated light reflected off a mirror, through the fiber at right angles to the axis, and into a video camera. The video camera connects both to a screen for the operator and to a computer that analyzes the images.

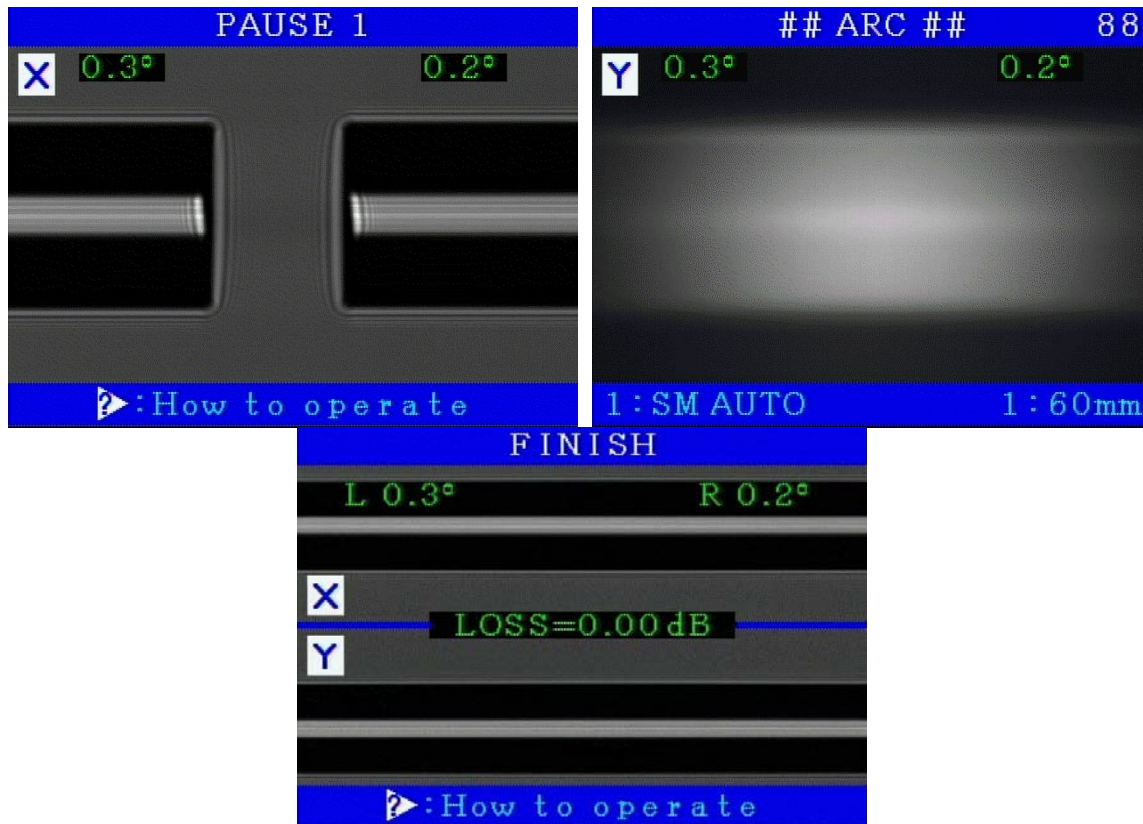

Figure 4-11. - Estimated Loss

Because of the way light is refracted by different refractive indices of the fiber, the cladding will appear dark and the core will appear light. The splicer's computer analyzes the images to locate the centerlines of the cores. The computer then moves the fibers into alignment. The camera can move to analyze the fiber on two perpendicular planes. Once the fibers are aligned, the computer will estimate the loss of the splice. See Figures 4-11. If the value is not acceptable, the operator can clean the fibers or recleave them. Once the loss is within acceptable limits, the operator initiates the fuse cycle. After the splice is complete, the operator can view the alignment of the cores.

The biggest danger in fusion splicing is the fibers shifting along the axis during fusion due to the surface tension of the molten glass. The splicer, by knowing the parameters of the fiber and the arc discharge, can compensate automatically for axis shift. Another danger is that fusion splices have had their mechanical strength members removed as part of the process. This leaves them open to failing under stress. Typically a

heat shrinkable sleeve is applied over the splice to protect it from stress. A fusion splice generally will fail close to but not exactly at the splice point.

Optical fibers might have to be spliced for a number of reasons. In the commercial industry, optical fibers may need to be fusion spliced due to longer lengths of optical fiber needed for network installs or fiber damage which requires emergency repair. In addition, splices might be required at building entrances to transition to properly rated cable, wiring closets or potentially any point between a transmitter and receiver. Optical fiber splices also permit repair of optical fibers damaged during installation, accident, or stress. System designers generally require fiber splicing whenever repeated connection or disconnection is unnecessary or unwanted.

In the military environment, there are a number of reasons why fusion splicing is preferred if repeated connection or disconnection is unnecessary. One reason splicing is preferred is to reduce the amount of time it takes to complete the installation of fiber connections in a Fiber Optic Interconnection Box (FOICB). This reduction in time is possible because the alternative to fusion splicing is to terminate and polish optical connectors and time associated with installing and testing fusion splices is reduced as compared to connectors.

System design may require that fiber connections or links have specific optical properties (low loss) that are met only by splicing fibers. Fusion splicing allows for less optical loss within a given optical link. For optical power budgeting purposes, fusion splicing increases the amount of power in a given link since coupled connector loss is out of the picture. Fusion splicing has the potential to save money for the Navy with regards to the time involved for installing and testing Fiber Optic Cable Plants (FOCPs).

Another example is to possibly eliminate the amount of FOICBs throughout Navy vessels. This is possible due to potentially allowing more connections within each FOICB. The FOCP is designed to be as maintenance free as possible. Therefore, with fusion spliced optical fibers within the FOICBs, there is no need for cleaning and/or repairing optical connectors.

Advantages to Fusion Splicing

Fusion splice joints are compact, exhibiting an area no larger than the original optical fiber. This does not include when optical splices are protected by a protective sleeve. Optical loss and reflectance of a fusion splice are typically much lower than alternative fiber connecting technologies. Fusion splices are permanent and they exhibit mechanical strength and long-term reliability that approaches the original fiber.

Fusion splices are very stable to their alignment. They can withstand extremely high temperatures or extremely high optical power densities. They do not allow dust or contaminants to enter the optical path and reduction in optical testing.

Disadvantages to Fusion Splicing

Splicing requires special training to operate the fusion splicing equipment. However, what doesn't require special training nowadays! Upfront costs for equipment and materials have the potential to be costly (\$18,000 for a splicer). Generally, the splicer is the more expensive, while the splicing materials are the cheaper. Routine maintenance is required for the fusion splicing equipment. The preventative/routine maintenance schedule is based on the number of splices completed not a period of time.

Lack of understanding of fusion splice technology can be detrimental to the outcome of the fusion splices if not corrected. Most fusion splicers make it difficult to make a bad splice, however the potential is still there. That is why special training is needed.

Q15. Define a fiber optic splice.

Q16. Fiber splicing is divided into two broad categories that describe the techniques used for fiber splicing. What are they?

Q17. How often should the electrodes be replaced on a fusion splicer?

Q18. What are the advantages to fusion splicing over conventional terminations?

MECHANICAL SPLICES



Figure 4-12. - Splices, from left, Fusion Splice, Elastomeric, Ultrasplice, Camlock, FiberLok, AT&T Rotary Splice

Mechanical splices, see figure 4- 12, are used to create permanent joints between two fibers by holding the fibers in an alignment fixture and reducing loss and reflectance with a transparent index matching gel or optical adhesive between the fibers that matches the optical properties of the glass. Mechanical splices generally have higher loss and greater reflectance than fusion splices, and because the fibers are crimped to hold them in place, do not have a strong fiber retention or pull-out strength. The splice component itself, which includes a precision alignment mechanism, is more expensive than the simple protection sleeve needed by a fusion splice.

Mechanical splices are most popular for fast, temporary restoration or for splicing multimode fibers in a premises installation. They are also used - without crimping the fibers - as temporary splices for testing bare fibers with OTDRs or OLTSs. Of course most prepolished splice connectors (the Navy refers to these as quick connect connectors or QCCs) use an internal mechanical splice (several actually have fusion splices) so the mechanisms and techniques described here apply to those also.

The advantage of mechanical splices is they do not need an expensive machine to make the splices. A relatively simple cleaver and some cable preparation tools are all that's needed, although a visual fault locator (VFL) is useful to optimize some types of splices.

Alignment Mechanisms

The biggest difference between mechanical splices is the way the fibers are aligned. Here are some typical methods.

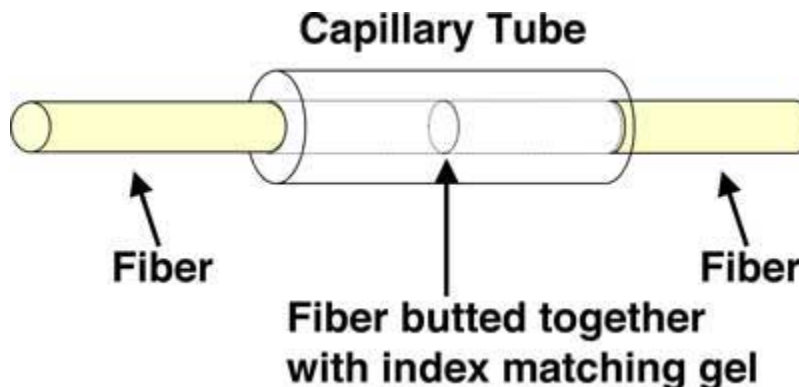

Figure 4-13. - Capillary Tube

The simplest method of making a mechanical splice is to align two fibers in a small glass tube with a hole just slightly larger than the outside diameter of the fibers and butt the ends together. This type of splice works well with UV-curable adhesive as well as an index-matching gel located between the fibers. The Ultrasplice is a capillary splice see figure 4-13.

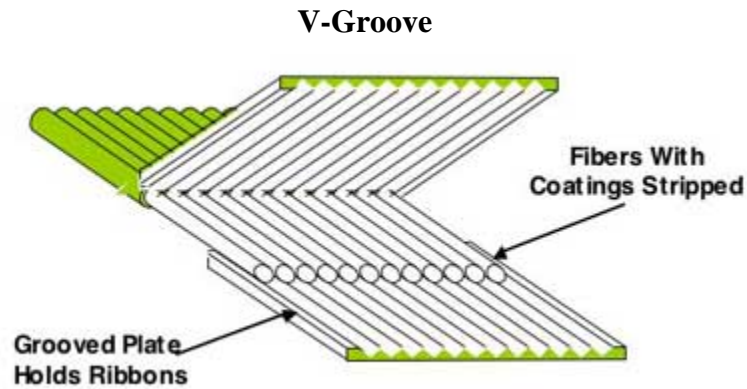

Figure 4-14. - Fixed V-Groove Splices

Fixed V-groove splices are quite simple and work well. They work for single fibers or even for fiber ribbons as shown here. The grooved alignment plates can be made of many types of materials and are quite inexpensive, see figure 4-14.

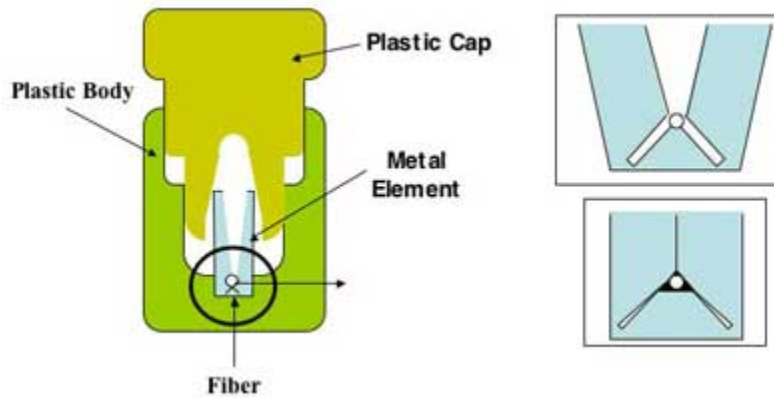

Figure 4-15. - 3M Fiberlok

The 3M Fiberlok, see figure 4-15, is a version of a V-groove splice that uses a metal stamping inside a plastic case to both align fibers and crimp them. It's elegant design and good performance has made it one of the most popular mechanical splices.

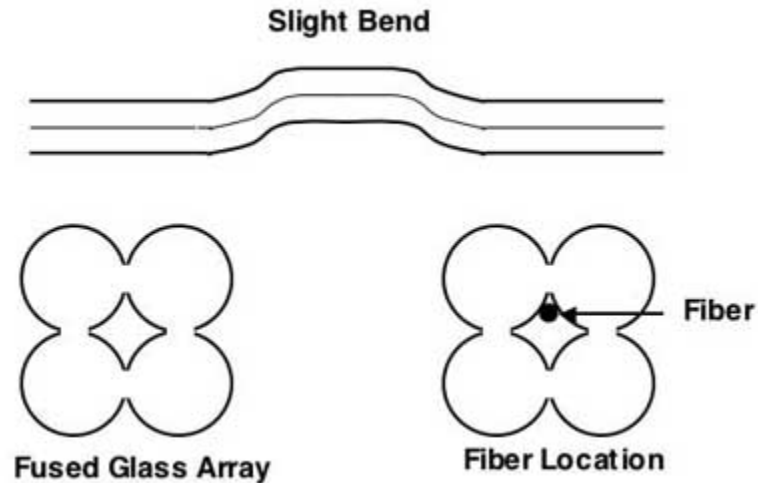

Figure 4-16. - Fused Glass Array

The fused glass array, see figure 4-16, method has a more complex alignment mechanism, made from four small glass rods fused together with a bend in the middle. The fibers follow the grooves made by the joint of two rods. The complexity and expense of this, especially compared to a simple V-groove, limited its use.

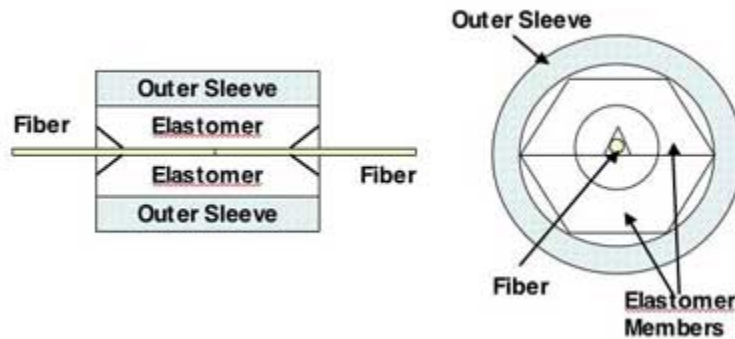

Figure 4-17. - GTE Elastomeric Splice

The GTE Elastomeric splice (still available from Corning) see figure 4-17, uses soft elastomers to hold the fibers in position. It's similar to a fixed v-groove, but the grooves are soft so they accommodate slight variations in fiber diameter easily.

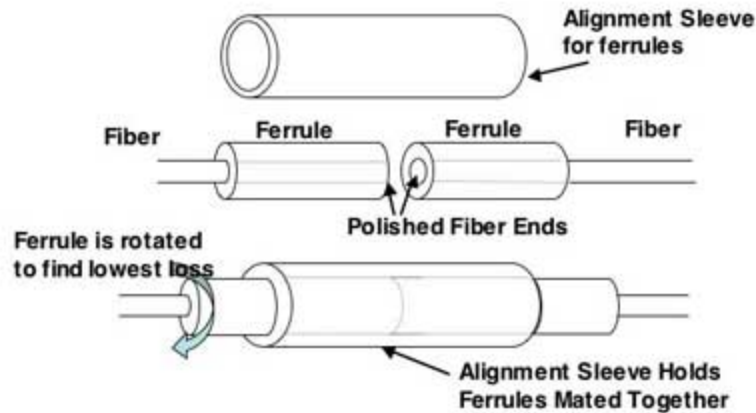

Figure 4-18. - Rotary Mechanical Splice

The AT&T Rotary splice, see figure 4-18, is more like a connector. The fibers are glued into glass ferrules and polished. They are then inserted into an alignment sleeve and rotated until the lowest loss is obtained, this is called tuning the splice. Again, complexity and cost, plus labor required, limited their popularity. **NOTE:** This splice is approved by the Navy and is currently installed in all the AGEIS platforms. The installation methods are found in MIL-STD 2042() Part 5 Method C.

The Tyco LightCrimp* Splices (P/N 1985368-1 or A-A-59917) see Figure 4-19, are used in the commercial industry for new installations and repair of telephone company central offices, CATV head ends, inter-building backbones and customer premise applications. The Navy has approved this splice only for use as a damage control repair replacement for an existing fusion splice. This splice has been approved (FEB 2013) and is listed on the current Qualified Parts List (QPL). The completed splices are intended to be stored in a qualified MIL-DTL-24728/8 splice tray and splice tray holder mounted inside a qualified MIL-I-24728 fiber optic interconnection box.



Figure 4-19. - Tyco LightCrimp Mechanical Splice

Cleaving Is Important

The most important step in mechanical splicing is cleaving the fiber properly. Most mechanical splicing kits come with an inexpensive cleaver that looks like a stapler or a beaver's tail and hence is commonly called a beaver cleaver, see figure 4-20.



Figure 4-20. - Fitel S-315A Single Fiber Cleaver (Nick Named - Beaver Tail Cleaver)

While this cleaver can produce quality results, its operation requires some practice and consistent use. The same can be said of all inexpensive hand-held cleavers. A better choice is one of the more expensive cleavers used for fusion splicers. It's cost is offset quickly by producing higher yields. See figure 4-21 showing examples of good and bad cleaves.



Figure 4-21. - Examples of Cleaves

Mechanical Splicing Process

Cable and fiber preparation is practically the same as for fusion splicing.

Prepare the cables to be spliced

Ensure all jacketing material, Kevlar and fillers are removed leaving only the OFCCs. Remove the OFCC 2mm jacket about 8 to 10 inches exposing the 900um tight buffer for splicing. Ensure that there is enough tight buffer left for dressing the buffer tubes and fibers in the splice closure. Leave the proper amount of strength members to

attach the cable to the closure. Refer to the direction and methods for installing a mechanical splice found in the Emergent Repair Kit. (If not found onboard contact the ISEA at NSWC Dahlgren Va.) Remove the tight buffer about 30-40mm exposing the glass fibers for splicing. Generally splice closures will require ~1 m buffer tubes inside the closure to and ~ 1 m fiber inside the splice tray.

Prepare the fibers to be spliced

The process is the same for all splice types: strip, clean & cleave. Each fiber must be cleaned thoroughly before stripping for splicing. When ready to splice a fiber, strip off the buffer coating(s) to expose the proper length of bare fiber. Clean the fiber with appropriate wipes. Cleave the fiber using the process appropriate to the cleaver being used.

Splicing

Most splices are designed to limit the depth of the fiber insertion by the buffer coating on the fiber. Some splices clamp both fibers at once. Insert the first fiber until it bottoms out. Then inset the second until you see the first fiber move. That tells you the two butt ends are touching. Once the two ends are making contact clamp the fibers in place. If they are clamped separately inset the ends of the fibers until they bottom out and then clamp both individually in place.

Optimizing Splices Using A Visual Fault Locator

You can improve the loss of a mechanical splice by gently withdrawing one of the fibers a slight amount, rotating it slightly and reinserting it. It works best with a VFL (visual fault locator) if the fiber ends that are being spliced are visible.

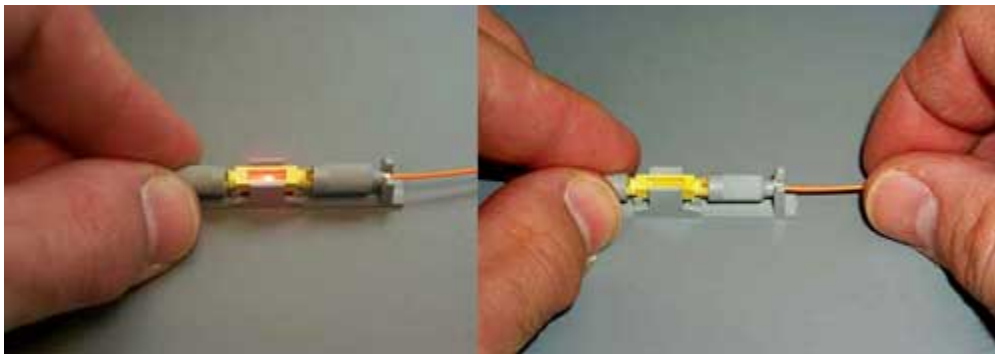

Figure 4-22. - Checking a Splice with a VFL

Shine a visual fault locator into the fiber and note the light loss at the splice, see Figure 4-22 (Left in photo). Pull one fiber out by 1-2 mm (about 1/16 inch.). Rotate the fiber slightly and reinsert fully. Keep trying and watch for minimal light (Right in photo.) Crimp fiber in place.

19. *What are some of the advantages of using a mechanical splice?*

Q20. *The Navy recommends using what two mechanical splices?*

Q 21. *What piece of test equipment makes it easy to locate a bad splice?*

FIBER OPTIC CONNECTORS

A **connector** is a disconnectable device used to connect a fiber to a source, detector, or another fiber. It is designed to be mated and demated many times. A **splice** is a device used to connect one fiber to another permanently.

The key to a fiber-optic interconnection is precise alignment of the mated fiber cores (or the mode field diameter in single-mode fibers) so that nearly all the light is coupled from one fiber across the junction into the other fiber. Contact between the fibers is not even mandatory. The demands of precise alignment on small fibers create a challenge to the designer of the connector or splice. TIA 568-B states the maximum allowable loss per splice is .3 dB and the maximum allowable loss per mated pair is .75 dB. The following is a list of desirable features for a fiber-optic connector or splice:

Low loss- the connector or splice should cause little loss of optical power across the junction.

Easy installation- the connector or splice should be easily and rapidly installed without need for extensive special tools or training.

Repeatability- a connector should be able to be connected and disconnected many times without changes in loss.

Consistency- there should be no variation in loss; loss should be consistent whenever a connector is applied to a fiber.

Economical- the connector or splice should be inexpensive, both in itself and in special application tooling.

Light-duty connectors and **heavy-duty connectors** are two ways that the Navy classifies fiber optic connectors. The light-duty connector in shipboard applications has to be housed in areas that protect it from the environment such as in an interconnection box or equipment enclosure. The single terminus connector has a heavy duty spring and is keyed. It has a 2.5mm ferrule and is pre-radiused for dome end polishes for either

multimode or single mode applications. They are described in specification sheets 16, 17, and 18 of MIL-C-83522. Figure 4-23 shows a sample of the ST light-duty connector.



Figure 4-23. - ST Light Duty Connector

Figure 4-24 shows one type of heavy-duty connector designed for use in harsh Navy environments. This connector is described by the military specification MIL-C-28876. This connector comes in various sizes capable of 4, 8 or 31 channels. Each channel is terminated using a MIL-PRF-29504 pin or socket termini. The pin is housed in the plug end and the socket is housed in the receptacle. The pin and socket are joined together in an alignment sleeve, which attaches to the ceramic ferrule. Fiber alignment occurs when the pin terminus slides into the alignment sleeve of the socket terminus. The termini are held within an insert, called the nest, in the connector shell. When the connector halves are mated, the connector inserts align the mating termini, which then align the mating fibers. The connector shell and back shell protect the termini from the surrounding environment and provide strain relief for the multifiber cable.

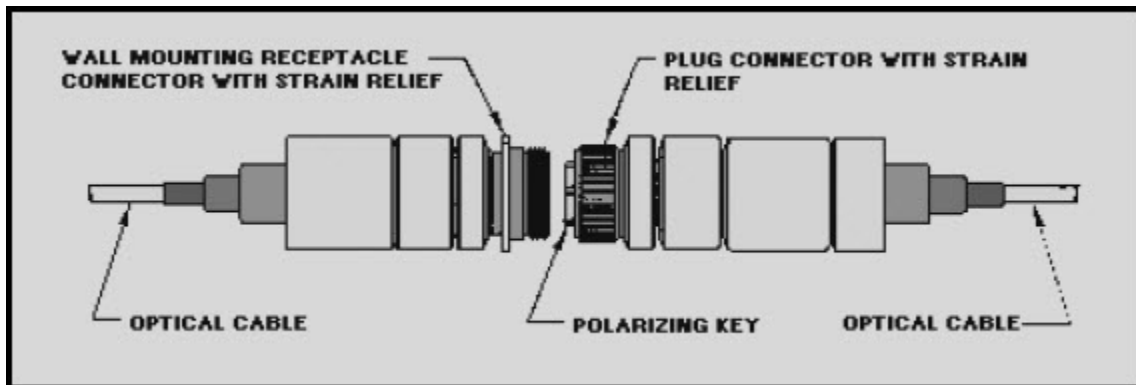

Figure 4-24. - MIL-C-28876 Heavy-Duty Connector

Another type of multi-terminus connector is the Hermaphroditic that comes in numerous configurations. The Navy uses the 4 and 12 channel configurations. See Figure 25. The 12 channel is used for pier side connectivity for all communications while in port stateside.



Figure 4-25. 12. - Channel and 4 Channel Hermaphroditic Connector

Figure 4-26 shows how an expanded-beam connector uses two lenses to expand and then refocus the light from the transmitting fiber into the receiving fiber. Expanded-beam connectors are normally plug adapter- plug type connections. Fiber separation and lateral misalignment are less critical in expanded beam coupling than in butt-jointing. The same amount of fiber separation and lateral misalignment in expanded beam coupling produces a lower coupling loss than in butt-jointing. However, angular misalignment is more critical. The same amount of angular misalignment in expanded-beam coupling produces a higher loss than in butt-jointing. Expanded-beam connectors are also much harder to produce. Present applications for expanded-beam connectors include multifiber connections, edge connections for printed circuit boards, and other applications.

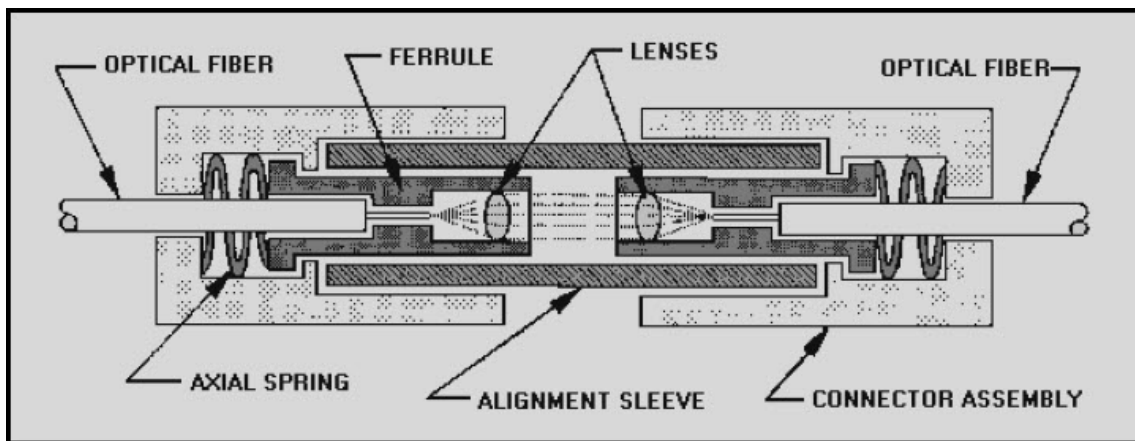

Figure 4-16. - Expanded-beam connector operation

Q 22. What qualities are desirable features of a connector?

Q 23. What two ways does the Navy classify connectors?

Causes of Loss in an Interconnection

There are three different types of factors that can cause loss in fiber-optic interconnections:

1. Intrinsic or fiber-related factors are those caused by variations in the fiber itself.
2. Extrinsic or connector-related factors are those contributed by the connector itself.
3. System factors are those contributed by the system.

Intrinsic factors are loss factors caused in the manufacturing process. NA-mismatch loss occurs when the NA of the transmitting fiber is larger than that of the receiving fiber. Core-diameter-mismatch loss occurs when the core or diameter of the transmitting fiber is larger than that of the receiving fiber. Cladding-diameter-mismatch loss occurs when the claddings of the two fibers differ, since the cores will no longer align.

Concentricity loss occurs because the core may not be perfectly centered in the cladding. The geometric axes of the core and cladding should coincide.

Ellipticity (or ovality) loss occurs because the core or cladding may be elliptical rather than circular. The ellipticity or ovality tolerance of the core and cladding equals the minimum diameter divided by the maximum diameter.

These variations exist in any fiber. The manufacturer controls these variations by manufacturing fiber to tight tolerances. In the past few years, manufacturing techniques have improved significantly that fiber tolerances are much tighter, typically +/- 0.2 μm , resulting in a range of 123 to 127 μm and a maximum loss of 0.28 dB.

Extrinsic factors contributing to loss occur when two fibers are not perfectly aligned on their center axes, even if there is no intrinsic variation in the fibers. The loss results from the difficulty of manufacturing a device to the exacting tolerances required. The four main causes of loss that a connector or splice must control are:

1. Lateral displacement
2. End separation
3. Angular misalignment
4. Surface roughness

Lateral displacement is when one fiber's axis does not coincide with that of the other. Loss is determined by the ratio of the lateral offset to the fiber diameter. The acceptable offset becomes less as the fiber diameter becomes smaller. Connector manufacturers attempt to limit displacement to less than 5% of the core diameter.

End separation between two fibers will result in two types of loss. The first is Fresnel reflection loss, which is caused by the difference in refractive indices of the two fibers and the air gap.

Connectors and Installation

After fiber optic cables have been installed, connectors shall be used to interconnect two optical cable components (OFCC's) inside an interconnection box or equipment. It should be apparent by now that optical fibers cannot be terminated using the same tools and procedures used to terminate metallic conductors in conventional communication cables.

Where termination of copper conductors is dependent upon a solid metal-to-metal contact, the termination of optical fibers is dependent upon alignment of the fiber cores. The fibers must be configured in such a way as to provide maximum light transfer between them. Connectors are designed to provide this alignment, and your job is to mount the fibers in the connectors in a way that will facilitate maximum alignment and hold the fibers firmly in place.

This topic will address the issues related to connector installation. First, we will discuss the purpose of connectors and the configurations in which they are used. Next the many styles of connectors available and how they may be used. The type and use of the basic tools and materials required and also take a look at basic procedures required for installing all connectors. Specific tools and procedures for the connectors used will be addressed in detail during the tool kit and connector demonstrations.

Purpose of Connectors

The termination of optical fibers is normally accomplished through the use of connectors. A connector is defined as a device that allows an optical fiber to be repeatedly connected or disconnected to cables, patch panels, transmitters (source) or receivers (detector). Please do not confuse a connector with a splice. A Fiber Optic splice is a permanent junction between two fibers not designed to be repeatedly connected.

Patch Cords - Patch cords are relatively short sections of jacketed or buffered fiber cable that are generally used to connect items of end equipment. A patch cord will have a connector at each end.

Pigtails - Pigtails are sections of cable with a connector only at one end, which is the end to be connected at the equipment. The other end of a pigtail will be spliced to the cable that enters from the field. Pigtails are often configured in an arrangement called "breakout" cable. The breakout cable is nothing more than multiple pigtails contained within a sheath. Pigtails or breakout cables have become less prevalent in recent years because installers are terminating the field cable directly to many equipment items. This higher standard has been adopted by the military. This eliminates a splice location at each end of the cable, which results in lower attenuation.

Furcation - Blown Optical Fibers (BOF) are made with 500 μm acrylate coating and most connectors are made to accommodate 2 or 3mm jacketed fibers with 900 μm buffer.

Blown Optical Fibers (BOF) with the 500 μm acrylate coating can be terminated using a furcation unit. An outer jacket with strength member is placed around the small buffer to build up the fiber for a connector fit. Blown Optical Fiber cable furcation terminate just like conventional fiber. See Figure 4-27.

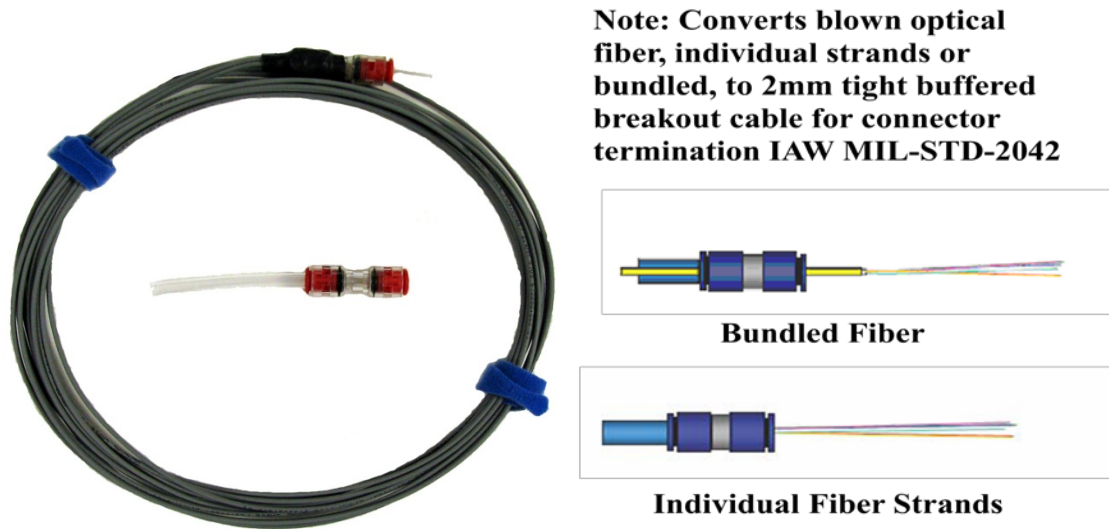

Figure 4-27. - Furcation Unit

Descriptions of Connectors

Connectors may be described in many different ways, depending on the criteria used. There are basic styles, each of which could include variables such as finishing technique or ferrule type. Connector quality can be based on bore quality, thermal properties, and mechanical properties.

Styles of Connectors

Standardization is a serious problem throughout industry and the military. Connector selection is one of the most affected areas. Only use those connectors listed in the contract or specification for the job or statement of work. Let's look at some of the most widely used connectors. As you become familiar with the connectors, keep three basic considerations in mind: (1) threaded connectors can cause big problems when excessive torque is used, (2) keyed connectors allow for consistent, repeatable alignment, (3) as more fiber is installed, termination space will become more valuable.

SMA CONNECTORS. SMA (Sub-Miniature, Type A) Connectors, originally designed by Amphenol, use a threaded coupling nut without a keying device. The two basic types are the 905 style and 906 style. The 905 uses a straight ferrule and the 906 has a step-down nose to allow use of plastic alignment bushings for maximum alignment. Originally designed with a steel ferrule for multimode applications, they are now available with ceramic ferrules for single-mode applications. The primary problems that

arise with the use of SMA connectors are crushing due to over-tightening of the threads, and repeatability of alignment because of the lack of a keying device.

BICONIC CONNECTORS. Named for their conical shape, many items of equipment installed during the 1980s still require interfacing using Biconic connectors. These were the first connectors used on single-mode fibers, although, they are available for single-mode or multimode applications. Biconic connectors are not keyed and early problems developed with repeatability and crushing due to over tightening. Later versions of Biconic connectors were available with a keying feature.

ST CONNECTORS. ST (Single Terminus) Connectors were designed by AT&T Bell Laboratories for use with single-mode or multimode fibers. They use quick-release keyed bayonet couplings that are preferred in situations where severe vibrations are not expected. The ST is probably the most popular and widely used connector in local area networks, test equipment and other applications. The keying feature ensures that the fiber is always inserted to the mating bushing with the same orientation. The bayonet coupling prevents crushing due to over-tightening.

FC CONNECTORS. Named FC for “field connector,” it was originally devised by Nippon Telephone and Telegraph (NTT) for telecommunications. It was used by MCI in its fiber optic telephone network in the 1980s. The connector has a threaded coupling feature similar to the SMA for use in high-vibration environments. The threads would be difficult to over tighten because stops have been installed to obtain repeatable torque. It also offers a keying feature similar to the ST, except that some FC connectors are “tunable.” The term “tunable” means the keying slot can be rotated to find optimal alignment and will remain in that alignment until moved again. The FC connector is available for single-mode and multimode applications.

SC CONNECTORS. Named SC from “subscriber connector,” it was also developed by NTT and gained popularity throughout the 1990s for both single-mode and multimode applications. They use a push-pull engagement for mating and are designed to be pull-proof so a slight pull on the cable will not disengage the connection. The SC connector is a strong competitor to the FC and ST connectors due to the ease in constructing multifiber connectors for duplex configurations. Connectors such as the FC, ST, and SMA that require twisting are not readily adaptable to multifiber connections in high-density applications because of the space required to allow rotation. AMP has already developed a mini SC for even higher density applications.

Connector End Finish

In addition to styles, the type of finish may categorize connectors. The three most common types of finishes are the flat finish, the physical contact (PC) or Angled Physical Contact (APC).

FLAT END FINISH. This type of finish is typically used on some of the older styles of connectors, such as the SMA, ST (non pre-radiused) and Biconic. The tip is

polished down flat in order to achieve perfect mating with another connector. It is nearly impossible to get two perfectly flat, perpendicular surfaces. This often prevents the fiber cores from touching. This air space between connectors creates a Fresnel reflection increasing loss. See Figure 4-28.

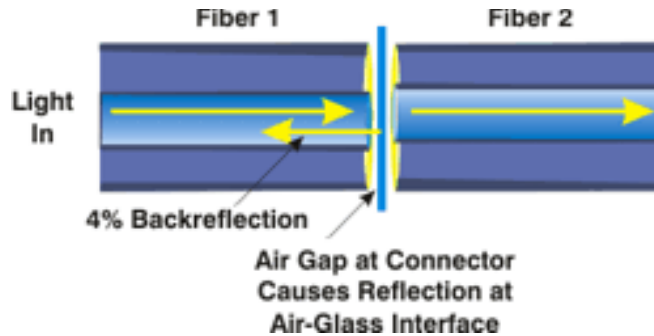

Figure 4-28. Connector Air Gap

PHYSICAL CONTACT (PC) OR DOMED FINISH. The PC is a finish technique applied to the fiber end face. Many manufacturers produce different styles of connectors with PC finishes. The PC ferrule end is domed with a high precision convex spherical end surface. PC finishes provide consistently lower losses than flat end face connectors, it reduces back reflection to 30 dB and PC virtually eliminates air spaces between mated connectors because the fibers will always touch near the core. ST, FC and SC connectors are available with PC finishes.

NOTE: For ST connectors, this procedure only works for connector ferrules that have been pre-radiused by the connector manufacturer. Some multimode optical fiber connectors may not have pre-radiused ferrules. When implementing this finish on multimode optical fiber connectors, verify with the manufacturer that the connectors have a pre-radiused ferrules. See Figure 4-29.

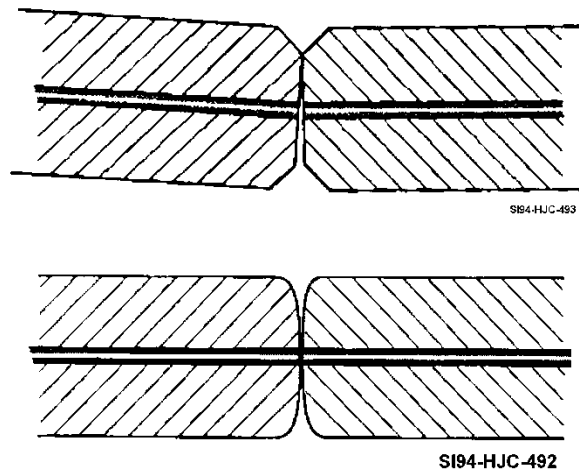

Figure 4-29. - Flat Finish and PC End Finish

Connector Ferrules

Another connector variable is the type of ferrule used to hold the fiber and provide alignment.

CERAMIC FERRULES. Ceramic ferrules offer the best performance and are preferred for use on both multimode and single-mode fibers. Ceramics are strong and have precision, machined fiber bores. They also have superior thermal and mechanical properties so performance does not vary due to temperature or environmental fluctuations. They are also the most expensive. MIL-SPEC connectors only use ceramic ferrules. There are two types of ceramic ferrules Zirconia and Alumina. Alumina ceramic produces a rough polish due to its chemical makeup whereas Zirconia ceramic produces highly polished connectors and is preferred in industry. Used on all MIL-SPEC connectors.

STAINLESS STEEL FERRULES. These are middle-grade ferrules that will have quality nearly equal to ceramic, but thermal performance may be considerably less reliable than ceramic. These connectors may be best suited in applications where temperature in the operating environment is stable. On the other hand, stainless steel ferrules are stronger than ceramic and less susceptible to breakage or cracking.

PLASTIC FERRULES. Plastic ferrules will be least expensive, and will also be less reliable than ceramic or stainless steel. These are also known as polymer or polymer composite.

Q 24. What factors cause loss in an interconnection?

Q 25. What four main factors must a connector or splice control?

Q 26. What is the purpose of a connector?

Q 27. Blown Optical Fiber uses what size acrylate coating?

Q 28. What does APC stand for?

Q 29. When can a dome polish be used on multimode fiber?

Q 30. What type of ferrule do MIL-SPEC connectors use?

FIBER OPTIC COUPLERS

Some fiber optic data links require more than simple point-to-point connections. These data links may be of a much more complex design that requires multi-port or other types of connections. Figure 4-30 shows some example system architectures that use more complex link designs. In many cases these types of systems require fiber optic components that can redistribute (combine or split) optical signals throughout the system.

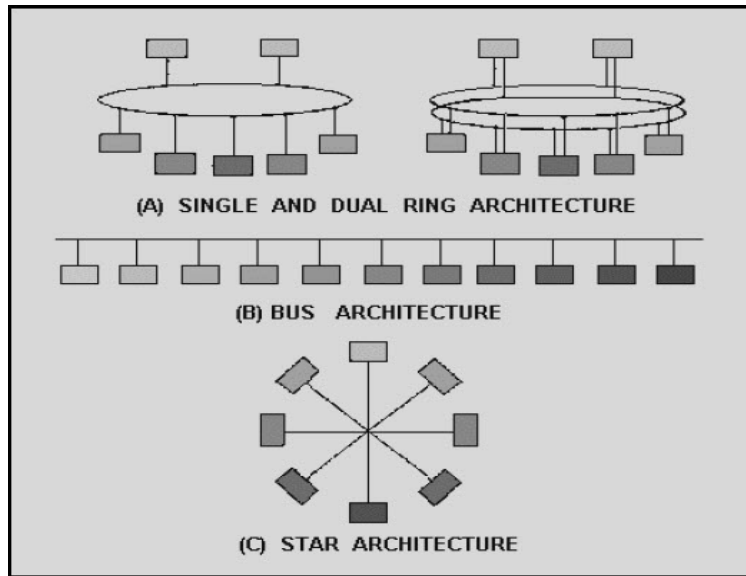

Figure 4-30. - Examples of Complex System Architectures

One type of fiber optic component that allows for the redistribution of optical signals is a fiber optic coupler. A fiber optic coupler is a device that can distribute the optical signal (power) from one fiber among two or more fibers. A fiber optic coupler can also combine the optical signal from two or more fibers into a single fiber. Fiber optic couplers attenuate the signal much more than a connector or splice because the input signal is divided among the output ports. For example, with a 1×2 fiber optic coupler, each output is less than one-half the power of the input signal (over a 3 dB loss). See Figure 4-31.



Figure 4-31. - 1 X 2 Fiber Optic Splitter

Fiber optic couplers can be either active or passive devices. The difference between active and passive couplers is that a **passive coupler** redistributes the optical signal without optical-to-electrical conversion. Active couplers are electronic devices that split or combine the signal electrically and use fiber optic detectors and sources for input and output.

Figure 4-32 illustrates the design of a basic fiber optic coupler. A basic fiber optic coupler has N input ports and M output ports. N and M typically range from 1 to 64. The number of input ports and output ports vary depending on the intended application for the coupler. Types of fiber optic couplers include optical splitters, optical combiners, X couplers, star couplers, and tree couplers.

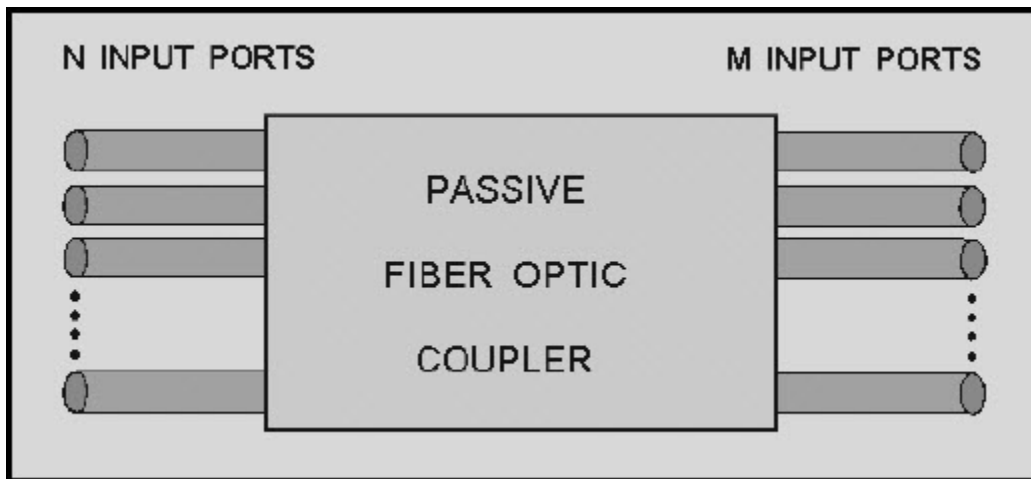

Figure 4-32. - Basic Passive fiber Optic Coupler Design

An **optical splitter** is a passive device that splits the optical power carried by a single input fiber into two output fibers. Figure 4-33 illustrates the transfer of optical power in an optical splitter. The input optical power is normally split evenly between the two output fibers. This type of optical splitter is known as a **Y-coupler**. However, an optical splitter may distribute the optical power carried by input power in an uneven manner. An optical splitter may split most of the power from the input fiber to one of the output fibers. Only a small amount of the power is coupled into the secondary output fiber. This type of optical splitter is known as a T-coupler, or an optical tap.

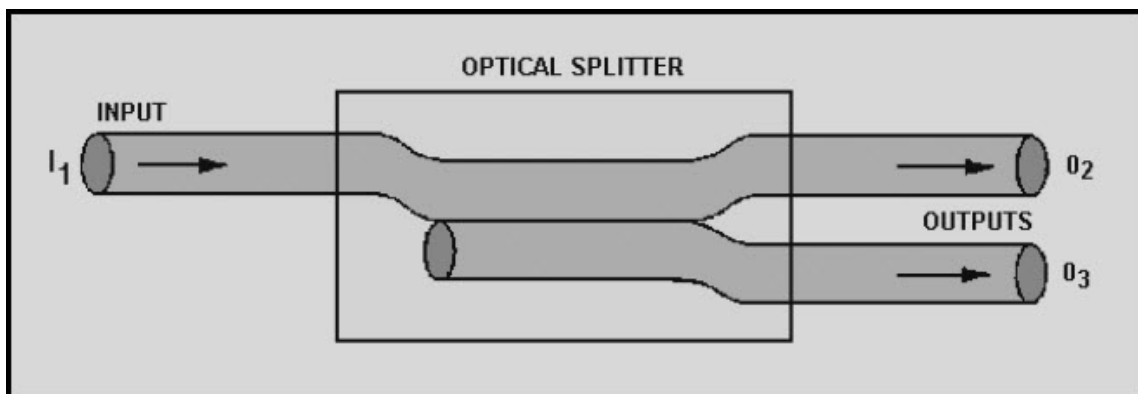

Figure 4-33. - Optical Splitter

An **optical combiner** is a passive device that combines the optical power carried by two input fibers into a single output fiber. Figure 4-34 illustrates the transfer of optical power in an optical combiner.

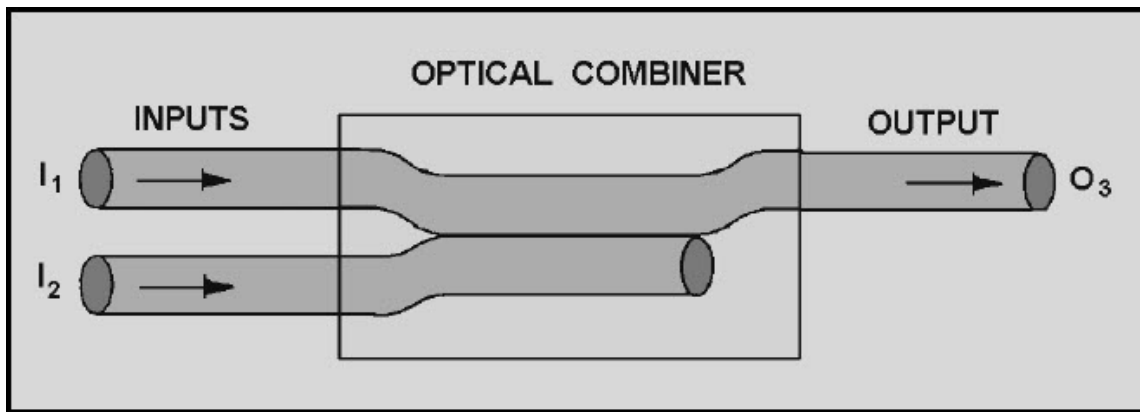

Figure 4-34. - Optical Combiner

An **X coupler** combines the functions of the optical splitter and combiner. The X coupler combines and divides the optical power from the two input fibers between the two output fibers. Another name for the X coupler is the 2×2 coupler.

Star and tree couplers are multiport couplers that have more than two input or two output ports. A **star coupler** is a passive device that distributes optical power from more than two input ports among several output ports. Figure 4-35 shows the multiple input and output ports of a star coupler. A **tree coupler** is a passive device that splits the optical power from one input fiber to more than two output fibers. A tree coupler may also be used to combine the optical power from more than two input fibers into a single output fiber. Figure 4-36 illustrates each type of tree coupler. Star and tree couplers distribute the input power uniformly among the output fibers.

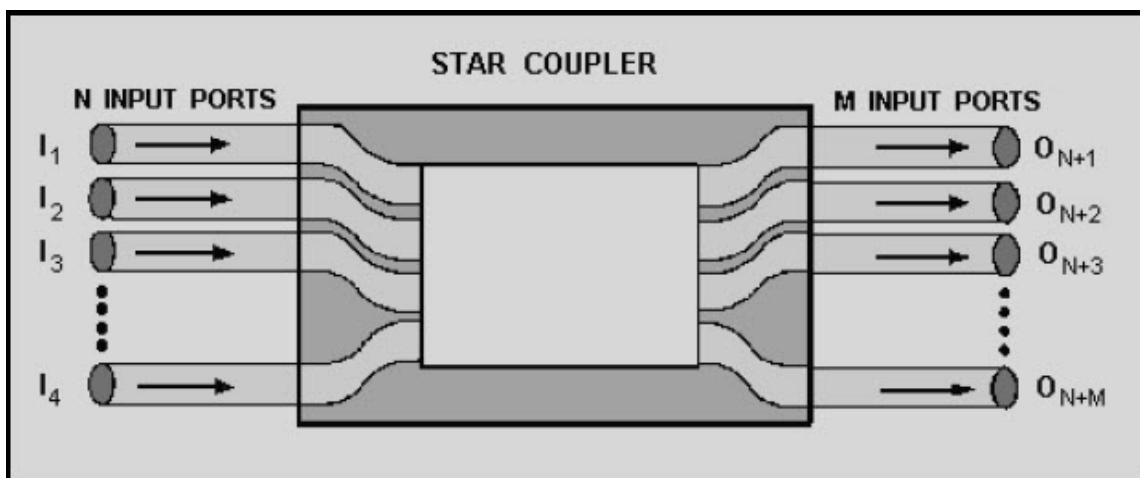

Figure 4-35. - Star Coupler

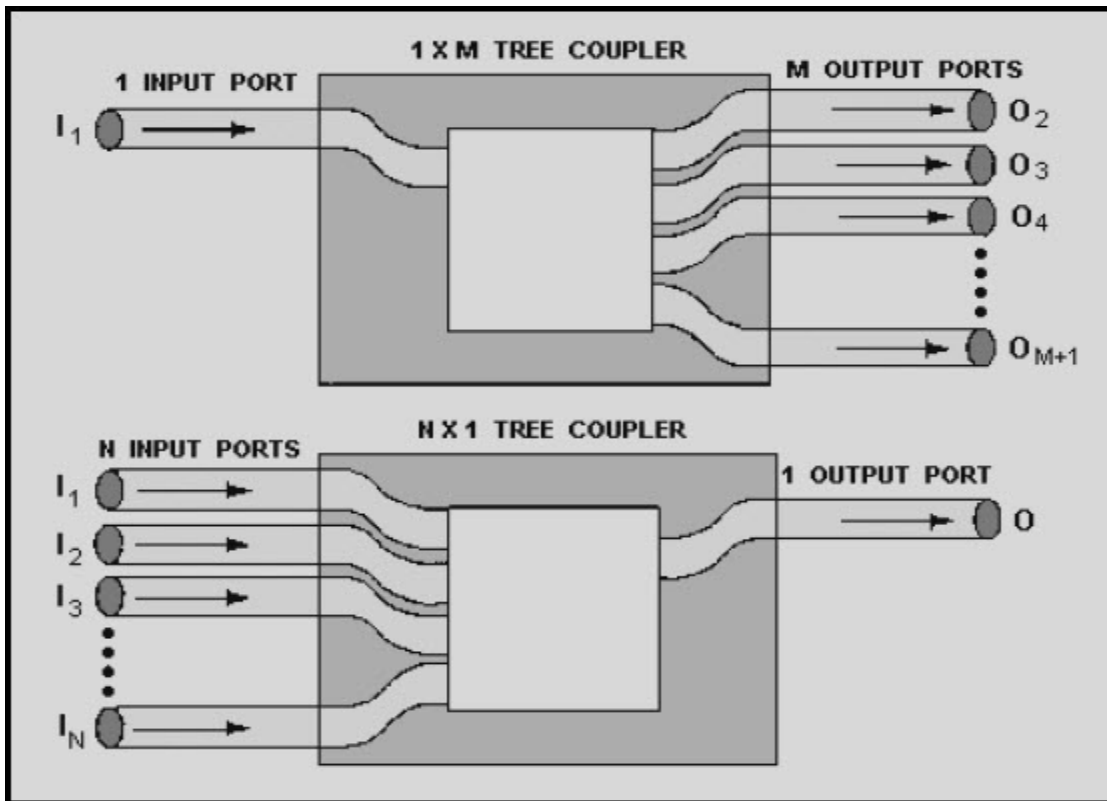

Figure 4-36. - (X M) and (N X 1) Tree Coupler Designs.

Fiber optic couplers should prevent the transfer of optical power from one input fiber to another input fiber. **Directional couplers** are fiber optic couplers that prevent this transfer of power between input fibers. Many fiber optic couplers are also symmetrical. A **symmetrical coupler** transmits the same amount of power through the coupler when the input and output fibers are reversed.

Passive fiber optic coupler fabrication techniques can be complex and difficult to understand. Some fiber optic coupler fabrication involves beam splitting using micro lenses or graded-refractive-index (GRIN) rods and beam splitters or optical mixers. These beam splitter devices divide the optical beam into two or more separated beams. Fabrication of fiber optic couplers may also involve twisting, fusing, and tapering together two or more optical fibers. This type of fiber optic coupler is a fused biconical taper coupler. Fused biconical taper couplers use the radiative coupling of light from the input fiber to the output fibers in the tapered region to accomplish beam splitting. Figure 4-37 illustrates the fabrication process of a fused biconical taper coupler.

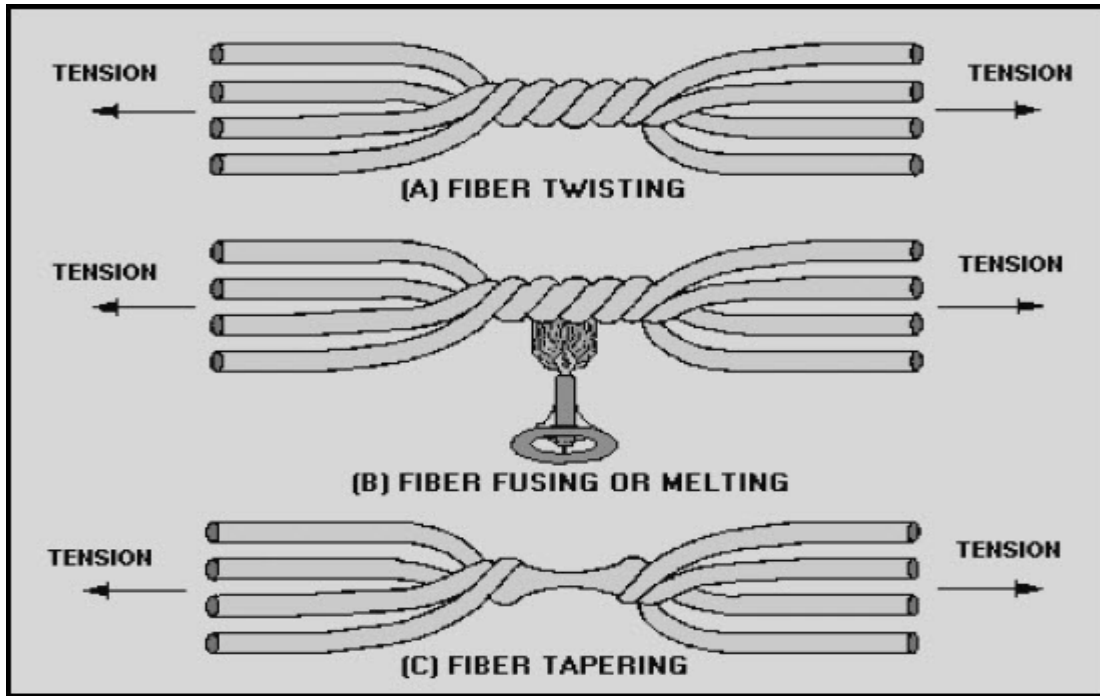

Figure 4-37. - Fabrication of a fused biconical taper coupler (star coupler)

Q31. What is the difference between passive and active fiber optic couplers?

Q32. Which type of optical splitter (Y-coupler or T-coupler) splits only a small amount of power from the input fiber to one of the output fibers?

Q33. Describe a directional coupler

SUMMARY

Now that you have completed this chapter, let's review some of the new terms, concepts, and ideas you have learned. You should have a thorough understanding of these principles before moving on to chapter 5.

FIBER OPTIC CONNECTIONS transfer optical power from one component to another. Fiber optic connections also permit fiber optic systems to be more than just a point-to-point data link.

A **FIBER OPTIC SPLICE** is a permanent joint between two fibers or two groups of fibers.

FIBER OPTIC CONNECTORS permit easy coupling and uncoupling of optical fibers.

FIBER OPTIC COUPLERS distribute or combine optical signals between fibers.

POOR FIBER END PREPARATION and **POOR FIBER ALIGNMENT** are the main causes of coupling loss.

FIBER-TO-FIBER COUPLING LOSS is affected by intrinsic and extrinsic coupling losses. **INTRINSIC COUPLING LOSSES** are caused by inherent fiber characteristics. **EXTRINSIC COUPLING LOSSES** are caused by jointing techniques.

A **FIBER PIGTAIL** is a short length of optical fiber (usually 1 meter or less) permanently fixed to a fiber optic component, such as an optical source or detector.

FRESNEL REFLECTION occurs twice in a fiber-to-fiber connection. A portion of the optical power is reflected when the light first exits the source fiber. Light is then reflected as the optical signal enters the receiving fiber.

INDEX MATCHING GEL eliminates or reduces the step change in the refractive index at the fiber interface, reducing Fresnel reflection.

INTRINSIC ATTENUATION is the loss that occurs due to manufacturing processes.

EXTRINSIC ATTENUATION is the loss caused by external forces being applied to the cables and connections.

MAXIMUM ALLOWABLE LOSS is the sum of the cable loss, connector loss and splice occurring in the optical cable plant. The MAL determines the pass/fail criteria of the optical link and cable plant.

POOR FIBER ALIGNMENT is a main source of coupling loss in fiber-to-fiber connections. The three basic coupling errors that occur during fiber alignment are fiber separation (longitudinal misalignment), lateral misalignment, and angular misalignment.

In **FIBER SEPARATION** a small gap remains between fiber-end faces after completing the fiber connection. **LATERAL**, or **AXIAL MISALIGNMENT** is when the axes of the two fibers are offset in a perpendicular direction. **ANGULAR MISALIGNMENT** is when the axes of the two fibers are no longer parallel.

SINGLE MODE FIBERS are more sensitive to alignment errors than multimode fibers because of their small core diameters and low numerical apertures.

The **MODE POWER DISTRIBUTION (MPD)** is the distribution of radiant power among the various modes propagating along the optical fiber.

Poor **FIBER END PREPARATION** is another source of extrinsic coupling loss. An optical fiber end face must be flat, smooth, and perpendicular to the fiber's axis to ensure proper fiber connection.

The **SCORE-AND-SCRIBE** method is the basic fiber cleaving technique for preparing optical fibers for termination.

POLISHING the fiber ends removes most surface imperfections introduced by the fiber cleaving process. Fiber polishing involves a step-down method. The first step is to air polish the connector to remove any rough shards left behind during the cleave. The next step involves polishing the relatively large epoxy bead down to a light haze. Next a medium grid polishing paper is used to remove all the adhesive left on the end face. The final step is polishing with a fine grit of paper that will produce a highly fine polished end face.

FIBER MISMATCHES are a source of intrinsic coupling loss. Types of fiber mismatches include fiber geometry mismatches, NA mismatch, and refractive index profile difference.

FIBER GEOMETRY MISMATCHES include core diameter, cladding diameter, core ellipticity, and core-cladding concentricity differences.

CORE DIAMETER MISMATCH causes coupling loss only if the launching fiber has a larger core radius than the receiving fiber.

NA MISMATCH causes coupling loss only if the launching fiber has a higher NA than the receiving fiber.

A **REFRACTIVE INDEX PROFILE DIFFERENCE** causes coupling loss only if the launching fiber has a larger profile parameter than the receiving fiber.

MECHANICAL and **FUSION SPLICING** are two broad categories that describe the techniques used for fiber splicing. A mechanical splice is a fiber splice where mechanical

fixtures perform fiber alignment and connection. A fusion splice is a fiber splice where localized heat fuses or melts the ends of two lengths of optical fiber together.

In **MECHANICAL SPLICING**, mechanical fixtures hold the two optical fibers in alignment for an indefinite period of time without movement. The amount of splice loss is stable over time and unaffected by changes in environmental or mechanical conditions.

ARC FUSION involves the discharge of electric current across a gap between two electrodes. By placing the fiber end between the electrodes, the electric discharge melts or fuses the ends of the fibers.

PREFUSION involves a short discharge of electric current across the gap between the electrodes. In prefusion the fiber ends are cleaned and rounded to eliminate any surface defects that remain from fiber cleaving.

A **FIBER OPTIC CONNECTOR** is a demateable device that permits the coupling of optical power between two optical fibers or two groups of fibers.

FIBER ALIGNMENT in a fiber optic connector is the critical parameter in maintaining total insertion loss below the required level.

FIBER OPTIC CONNECTORS can affect system performance by poor end face geometry and contamination issues. These problems will create high insertion loss and back reflection.

OPTICAL BACK REFLECTION is reduced by index matching gels in mechanical splices and crimp-on connectors and physical contact polishes.

BUTT-JOINTED and **EXPANDED BEAM CONNECTORS** are two ways to classify fiber optic connectors. Butt-jointed connectors bring the prepared ends of two fibers into physical contact with each other. Expanded beam connectors use two lenses to first expand and then refocus the light from the transmitting fiber into the receiving fiber.

LIGHT-DUTY and **HEAVY-DUTY CONNECTORS** are two ways that the Navy classifies fiber optic connectors. Light-duty connector shipboard applications include locations that protect the connectors from the environment such as in an interconnection box. Heavy-duty applications require a very rugged, stand-alone, sealed connector.

A **PASSIVE COUPLER** redistributes an optical signal without optical to electrical conversion.

An **OPTICAL SPLITTER** is a passive device that splits the optical power carried by a single input fiber into two output fibers.

An **OPTICAL COMBINER** is a passive device that combines the optical power from two input fibers into a single output fiber.

A **STAR COUPLER** is a passive device that distributes optical power from more than two input ports among several output ports.

A **TREE COUPLER** is a passive device that splits the optical power from one input fiber to more than two output fibers. A tree coupler may also be used to combine the optical power from more than two input fibers into a single output fiber.

DIRECTIONAL COUPLERS are fiber optic couplers that prevent the transfer of optical power from one input fiber to another input fiber.

A **SYMMETRICAL COUPLER** transmits the same amount of power through the coupler when the input and output fibers are reversed.

ANSWERS TO QUESTIONS Q1. THROUGH Q33.

- A1. *Contamination.*
- A2. *400X microscope.*
- A3. *Video Inspection Probe*
- A4. *Cable loss, Splice loss and Connector loss.*
- A5. *Intrinsic losses are caused by manufacturing processes and Extrinsic losses are caused by external forces being applied to the cables and connections.*
- A6. *Decibels or dB.*
- A7. *Fiber separation (longitudinal misalignment), lateral misalignment, and angular misalignment.*
- A8. *Angular misalignment.*
- A9. *Physical Contact*
- A10. *Single mode.*
- A11. *Mechanical stripping.*
- A12. *Score-and-cleave.*
- A13. *Core diameter mismatch, cladding diameter mismatch, core ellipticity, core and cladding concentricity differences, NA mismatch, and refractive index profile differences.*
- A14. *Yes*
- A15. *Is a permanent joint whose purpose is to establish an optical connection between two individual optical fibers..*
- A16. *Mechanical and fusion splicing.*
- A17. *Every 1000 arcs.*
- A18. *Optical loss and reflectance are much lower, are permanent, stable, and do not allow dust to enter the optical path.*

- A19. *Temporary restoration or for splicing multimode fibers in a premises installation. They do not need expensive machines, just a simple cleaver and some preparation tools.*
- A20. *The AT&T Rotary splice and the Tyco LightCrimp.*
- A21. *Visual Fault Locator (VFL).*
- A22. *Low loss, easy installation, repeatability, consistency, economical.*
- A23. *Light duty and heavy duty connectors.*
- A24. *Intrinsic, extrinsic and system losses.*
- A25. *Lateral displacement, end separation, angular misalignment, surface roughness*
- A26. *A connector is defined as a device that allows an optical fiber to be repeatedly connected or disconnected to cables, patch panels, transmitters or receivers..*
- A27. *500um.*
- A28. *Angled Physical Contact.*
- A29. *When the connector has a pre-radiused ferrule..*
- A30. *Zirconia Ceramic.*
- A31. *Passive couplers redistribute optical signals without optical-to-electrical conversion.*
- A32. *T-coupler.*
- A33. *A fiber optic coupler that prevents the transfer of power between input fibers.*

CHAPTER 5

FIBER OPTIC MEASUREMENT TECHNIQUES

LEARNING OBJECTIVES

Upon completion of this topic you should be able to do the following:

1. Describe the value for conducting accurate test measurements.
2. Describe the various types of testing of fiber optic test equipment and types of measurements.
3. List factors of determining Maximum Allowable Loss.
4. Describe the reasons for maintenance / cleaning all fiber optic components prior testing and mating.
5. Understand the various methods of optical loss test measurements using an optical loss test set (OLTS).
6. Describe measurement quality jumpers (MQJ's) and launch cables.
7. Understand how to interpret an optical time domain Reflectometer (OTDR).
8. Describe a mode filter and when it will be used.
9. Describe Blown Optical Fiber cable tests.
10. Define the value of keeping fiber optic records.

FIBER OPTIC TEST MEASUREMENTS

The value of conducting accurate test measurements is essential to ensure all weapons, communication, engineering and navigation equipment perform as designed. Efficiency of the fleet depends upon the quality control in the engineering of the products installed, the effectiveness of the installers, and the maintainer efforts. Reliable fleet response and readiness hinges on testing. A review of NEETS module 16 (Introduction to test equipment) may be beneficial to your study of fiber optic test equipment.

In order to maintain fiber optic topologies there are several types of measurements that are critical to fiber optic systems. For example: acceptance tests, assembly link loss test, attenuation test, continuity test, end-to-end attenuation test, installation tests, post-installation tests, and pre-installation tests are a few of these optical measurements. The dependability of communication between components of systems and subsystems require

accurate test measurements at all levels of production, installation and maintenance. In this chapter you will learn about some common testing practices many of which can be referenced to the Department of Defense document, Standard Practice for Fiber Optic Cable Topology Installation Standard Methods for Naval Ships or the Mil-Std-2042-6B (SH). Part six of the military standard practice provides detailed methods for testing optical fiber cable installations.

Conducting tests may be for the purpose of quality assurance or to locate a specific fault. Each measurement taken should be made with the expectation of having a test repeated regardless of who takes the measurement with the same results using the same tolerances. Confidence in these measurements begins with the calibration of all test equipment that will be used for quantitative measurements. Each command should have a test equipment manager to assure that all test equipment is maintained. Reliable and repeatable measurements are a factor of proper training, techniques and equipment maintenance.

There are several industry standards for testing fiber optic plants. For example fiber optic testing for navy aircraft is the NA01-1A-505-4. Building standards aboard naval installations (not ships) are Telecommunications Industry Association (TIA-568()). The standard for which fiber optics on naval vessels is used is the Military Standard-2042() SH. Depending on which standard and version was called out at the time of installation by the system drawing the system may have different allowances for acceptance testing. Although there are similarities in the various standards, proper knowledge and hands on training of these measurements are essential to fulfilling missions and tasks.

Acceptance Testing

Once a system is installed it has to have an accountability chain of acceptance, where a command representative takes ownership of the system. A Ships Operational Verification Test (SOVT) will give your command confidence in the ability of your system to perform in combat, in theater support and humanitarian rolls. System dependability is a direct result of proper testing and maintenance habits at the deck plate level. For example a link loss (attenuation test) is conducted at all points of the life of a fiber, upon acceptance, installation but also when the fiber is first manufactured.

Tests included at the manufacturing level are: Cutoff wavelength (single mode), Bandwidth (multimode), Dispersion, fiber geometry, core diameter, numerical aperture (multimode) and mode field diameter (single mode). The extensive list to identify all tests that are performed in the manufacturing process is beyond the scope of this training manual. We will discuss the field testing as it pertains to installation and maintenance.

Types of Measurements and Tests

As mentioned above, attenuation (link loss) testing is one critical test that is conducted for acceptance. There are other tests that are equally important. These tests are dependent on several factors. A major factor as to which tests will be performed is the type of cable that will be tested (conventional or blown fiber). If the fiber optic plant to

be tested is conventional tight buffered break out fiber cable there is one set of tests. If it is a loose tube air blown cable there are other tests to be performed. Simply knowing what type of cable will help to determine which tests will be conducted or required.

Blown optical fiber (BOF) plants have become prolific on board ship, cable testing is as critical as testing the fiber itself. When a blown optical fiber plant is installed unique test requirements assure the cable is sealed and not severely bent. Not conducting these tests could prevent the installation of the fiber into the BOF cable tubes therefore keeping the ship from fulfilling its primary duties. Similar to blown optical fiber cable, conventional cable has visual tests and bending parameters that must be strictly adhered to meet reliability and performance objectives. We will focus on the optical tests initially of conventional fiber tight buffered Breakout cable and BOF fiber optic cable test towards the end of this chapter.

Regardless of the type of cable and where it is in the lifespan, visual tests are critical to evaluation, after all it is optic. A visual test can be conducted by simply using your unaided eye to evaluate a cable plant, connectors, or cable and its components for any kind of discontinuity. These physical discontinuities can be excessive bends, nicks, cuts, abrasions, thin spots, wrinkles, burn marks, missing markings and labels. Visual tests may reveal significant cable failures prior to purchase, pre-installation and post installation. It is normally an easy test to perform but has great value to the technician at all stages of operation.

Q.1 What is the value of conducting accurate test measurements?

Q.2 Which standard document is utilized for installation of a fiber optic plant aboard a naval vessel?

Q.3 What is the purpose of a SOVT?

Q.4 What defects will a thorough visual inspection reveal?

CONTINUITY CHECKS

Visual Fault Locator

Another simple quality check is the continuity check. This check is often referred to as the “light check”. It is possible with multimode fiber (less so than single mode fiber) to use ambient light (or flashlight) to pass light from one end to the other if the fiber has already been terminated. This simple check will confirm that your system fiber is not severally broken, cross connected or otherwise labeled wrong in a junction box. A

specific tool utilized today with better results for this very same purpose is the visual fault locator (VFL). The VFL is typically a class 2 or class 3 laser operating in the visual spectrum of 635nm-665 nm (Red LASER). When the VFL is coupled properly to an optical fiber it will show through the length of the fiber several miles (kilometers) long if the fiber has good continuity.

Having a Visual Fault Locator (VFL) at your side in testing and troubleshooting is a quick effective way to check for continuity, breaks and in some cases bending losses. A typical VFL is a battery operated laser (class 2). The VFL will emit a bright red light upon exiting the fiber if there is continuity, however it does not necessarily mean the fiber is operational at a particular wavelength. If there is a dim light you can assume something is wrong.

The dim light could indicate several problems such as the fiber is shattered, poorly mated, bent excessively or extremely dirty. Although you will have confirmed a problem and a possible type of fault, such as a dim indication from the VFL indicates your path is more than likely valid, not cross connected, disconnected or completely broken. Remember if there is any continuity the VFL will get through the fiber. In other words if you see no light exiting the fiber you will have confirmed a problem exist as well but now the fault may be a cross connection, no connectivity, mislabeling of the fibers or the fiber is actually broken.

If a cable is on a spool a bare fiber adapter may be used to confirm continuity of each fiber in the cable. This is done by stripping the fiber under test back, clean the fiber and insert it in to the bare fiber adapter. Depending on the individual adapter manufacturer the fiber will attach with a small spring loading clamp to the 900 μ buffer. It is typical to have a 2.5 mm ferrule and attach it to the VFL. Then the far end will illuminate if the fiber has good continuity. The Bare fiber adapter can be used with an OTDR to validate fiber continuity. OTDR will be discussed later in this chapter.

Optical Leak Detector

A less common tool for continuity checks of the glass is the optical leak detector (OLD). The OLD is referred to by old timers in the electrical world as “the fox and the hound”. The OLD consists of two operating components the detector “sniffer” and the light source (serves as a signal generator). The detector senses infrared light (1300nm typically) and will illuminate an LED indicator when the infrared light is detected. Some detectors will give an audible tone (2 kHz typical) too when the transmitted light is detected.

OLD operation is simple, connect the battery powered light source to one end of the fiber and use the detector to determine if light has made it to the far end. The OLD will also determine if you have a broken fiber as well. For instance, as you trace the fiber out in a junction box if your visual inspection did not reveal a broken fiber the OLD will find breaks in the cable through the 900 micron buffer. Upon a closer visual inspection at that point you will probably see the discontinuity in the 900 micron buffered fiber jacket that was missed the first time with a visual evaluation.

Q.5 If a fiber has continuity at 650 nm will it have acceptable loss at other wavelengths?

Q.6 While using a VFL, poor continuity is recognized by what indication on the far end?

Q.7 Which device(s) power may penetrate the fiber 900 μ buffer?

Q.8 How many main components comprise an OLD?

INSPECTION and CLEANING

Cleaning

Cleaning is one of the most important procedures for fiber optic systems and is a requirement for quality connections between fiber optic equipment. Any contamination in the fiber connection can cause failure of that component and even failure of the whole system. Hence, clean components are a necessity for quality connections with fiber optics. When cleaning fiber components, the procedure must be followed correctly, precisely, and carefully with the goal of eliminating any dust or contamination. A clean component will connect properly; a dirty component may transfer contamination to the connector it is mated to, or it may damage the optical contacts. The goal is to eliminate any dust or contamination and to provide a clean environment for the fiber-optic connection. Remember that inspection, cleaning and re-inspection are critical steps which must be done before making any fiber optic connection.

- A 1-micrometer dust particle on a single-mode core can block up to 1% of the light (a 0.05dB loss).
- A 9-micrometer speck is still too small to see without a microscope, but it could completely block the fiber core. These contaminants can be more difficult to remove than dust particles. By comparison, a typical human hair is 50 to 75 micrometers in diameter, as much as eight times larger. So, even though dust may not be visible, it is still present in the air and can deposit onto the connector. In addition to dust, other types of contamination must also be cleaned off the end-face. Such materials include:
 - Oils (frequently from hands)
 - Film residues (condensed from vapors in the air)
 - Powdery coatings (left after water or other solvents evaporate away)

These contaminants can be more difficult to remove than dust particles and can also cause damage to equipment if not removed. Being that high powered lasers are now in use, any contaminant can be burned into the fiber end-face if it blocks the core while the laser is turned on. This burning may damage the optical surface enough that it cannot be cleaned.

The goal is to eliminate any dust or contamination and to provide a clean environment for the fiber-optic connection. Remember that inspection, cleaning and re-inspection are critical steps which must be done before making any fiber-optic connection. The contaminants on the connector end-face can come from many different sources. Airborne particles or oil from our hands can be trapped on the connector end-face. The materials from the polishing films can also be left on the connector. Contamination can also be caused by contact with the dust cap, another connector or an adaptor. In addition, it can come from the connector adapter or connector housing. No matter how a connector is contaminated, contamination on the optical connector could block the light and reduce the optical performance of the connector. Therefore the contamination must be considered in every step of the manufacturing process, field installation, testing, maintenance, reconfiguration, etc.

Effect on Light Signal

Contamination is the most common cause for degradation in the performance of optical connectors. The core of a single-mode fiber is typically 8 to 10 μm and 50 or 62.5 μm for multimode fibers with the cladding 125 μm . Light travels through the core, and the cladding area helps to bounce the light back to the core. So, a couple microns of contaminant can easily reduce the core opening and prevent light transmission particularly in the case of single mode fiber. Frequent reconnection and insufficient cleaning may result in contamination and damage to the connector end-face and poor test results.

General Reminders and Warnings

Review these reminders and warnings before inspecting and cleaning your fiber-optic connections.

- Always turn off any laser sources before you inspect fiber connectors, optical components or bulkheads.
- Always make sure that the cable is disconnected at both ends or that the card or pluggable receiver is removed from the chassis.
- Always wear the appropriate safety glasses when required in your area. Be sure that any laser safety glasses meet federal and state regulations and are matched to the lasers used within your environment.

- Always inspect the connectors or adapters before you clean.
- Always inspect and clean the connectors before you make a connection.
- Always use the connector housing to plug or unplug a fiber. Always keep a protective cap on unplugged fiber connectors.
- Always store unused protective caps in a resealable container to prevent the possibility of transferring dust to the fiber. Locate the containers near the connectors for easy access.
- Always discard used tissues and swabs properly.

Warnings:

- Never use alcohol or wet cleaning without a way to insure that it does not leave residue on the end face. It can cause damage to the equipment.
- Never look into a fiber while the system lasers are on.
- Never clean bulkheads or receptacle devices without a way to inspect them.
- Never touch products without being properly grounded.
- Never use unfiltered handheld magnifiers or focusing optics to inspect fiber connectors.
- Never connect a fiber to a fiberscope while the system lasers are on.
- Never touch the end face of the fiber connectors.
- Never twist or pull forcefully on the fiber cable.
- Never reuse any tissue, swab or cleaning cassette reel.
- Never touch the clean area of a tissue, swab, or cleaning fabric.
- Never touch any portion of a tissue or swab where alcohol was applied.
- Never touch the dispensing tip of an alcohol bottle.
- Never use alcohol around an open flame or spark; alcohol is very flammable.

Best Practices:

- Resealable containers should be used to store all cleaning tools (store end caps in a separate container). The inside of these containers must be kept very clean and the lid

should be kept tightly closed to avoid contamination of the contents during fiber connection.

- Never allow cleaning alcohol to evaporate slowly off the ferrule, it can leave residual material on the cladding and fiber core. This is extremely difficult to clean off without another wet cleaning and usually more difficult to remove than the original contaminant. Liquid alcohol can also remain in small crevices or cavities where it may re-emerge to contaminate the connector end-face. Proper cleaning and handling processes can decrease long-term degradation of fiber optic connectors in any environment.

General Inspection and Cleaning Procedures

The following section describes the connector cleaning process. Additional sections provide more detail on specific inspection and cleaning techniques. General Cleaning Process cleaning listed below will assist the technicians' efforts in cleaning fiber optic connectors.

1. Inspect the fiber connector, component, or bulkhead with a fiberscope.
2. If the connector is dirty, clean it with a dry cleaning technique.
3. Inspect the connector.
4. If the connector is still dirty, repeat the dry cleaning technique.
5. Inspect the connector.
6. If the connector is still dirty, clean it with a wet cleaning technique followed immediately with a dry clean to ensure no residue is left on the end-face. Note: Wet cleaning is not recommended for bulkheads and receptacles. Damage to equipment can occur.
7. Inspect the connector, again.
8. If the contaminate still cannot be removed, repeat the cleaning procedure until the end-face is clean.

NOTE: Never use alcohol or wet cleaning without a way to insure that it does not leave residue on the end-face. It can cause equipment damage.

Connector Inspection Technique

This inspection technique is done using a fiberscope to view the end-face. A fiberscope is a customized microscope used to inspect optical fiber components. The fiberscope should provide at least 200x total magnification. Specific adapters are needed

to properly inspect the end-face of most connector types (for example: 1.25 mm, 2.5 mm, or APC connectors).

NOTE: Depending on the optical microscope used, viewing quality may be different. A 400 x microscopes will provide a better view of the end face of a connector than a 200x. A 100x microscope should be used to check for deep cracks not contamination.

PROACTIVE INSPECTION is easy, and the benefits are:

- Reduced Network Downtime
- Reduced Troubleshooting
- Optimized Signal Performance
- Prevention of Network Damage

Always ***“INSPECT BEFORE YOU CONNECT”***

Q.9 What must be done before making any fiber optic connection?

Q10 In addition to dust what other contaminants must be cleaned off an end face?

Q11 What benefits will a proactive cleaning and inspection approach produce?

TEST EQUIPMENT

Optical Loss Test Set

In days past the technician was simply looking for continuity because loss budgets were so forgiving that any light passing would be suitable for communication and testing requirements. That is not the case today, with the advent of more sensitive receivers and higher biased transmitters the optical power requirements to drive these circuits, testing is much more finite. Simple continuity checks will not be adequate or acceptable for most testing. So for determining pass/fail performance upon installation we use calibrated test sets known as Optical Loss Test Set (OLTS). The OLTS consists of a calibrated light source and power meter.

OLTS are the workhorse for most fiber optic installations and repair efforts aboard ships. They usually are either multi-mode or single-mode with various modes and wavelength options. Regardless of the type (MM or SM) each work by using a stable

reference power and measuring the loss over the length to be tested. The power loss can be measured in decibels, dBm or watts/ μ watts.

In order to achieve repeatable results in using the OLTS it is required that Measurement Quality Jumpers (MQJ) be used to set the reference power and testing. MQJ's are specialty reference jumpers with high optical quality finishes. They are labeled and serialized as well. MQJ's like any jumper can be quickly and permanently damaged by mating if the technician is not cautious and meticulous in cleaning all components. MQJ's should always be the used when testing.

Loss Budgets

In order to meet operational commitments today's loss measurements need to be repeatable and accurate. There are budget constraints (optically and fiscally). Optical budgets and constraints are a direct result of engineering calculations.

Upon the design of the fiber optic plant the loss budget calculations are based on the operating parameters of the light source and receiver (dynamic range). The product of this equation is often referred to as the Loss Budget. The loss budget is what may be used in the SOVT for pass/fail criteria. When the system dynamic range figure is not available, a field calculation known as the Maximum Allowable Loss (MAL) should be used. Simply stated the MAL is a factor of connector loss limits (number of mated pairs being tested), cable loss limits at the operating wavelength testing is to be conducted at. MAL factors are listed below.

Link attenuation (loss budget) allowance calculation;

The link attenuation allowance is calculated as:

Link Attenuation Allowance (dB) = Cable Attenuation Allowance (dB) + Connector Insertion Loss Allowance (dB) + Splice Insertion Loss Allowance (dB)

where:

Cable Attenuation Allowance (dB) = Maximum Cable Attenuation Coefficient (dB/km) \times Length (km)

Connector Insertion Loss Allowance (dB) = Number of Connector Pairs \times Connector Loss Allowance (dB)

Splice Insertion Loss Allowance (dB) = Number of Splices \times Splice Loss Allowance (dB)

As stated above the MAL is a formula to determine what your loss may be in decibels if you do not have the link dynamic range. Link loss measurements are single links between junctions (boxes). Topology tests incorporate the end to end optical loss over a series of concatenated optical links.

Optical Time Domain Reflectometers Overview

Like the OLTS the Optical Time Domain Reflectometer (OTDR) has unique qualities that make evaluating an optical fiber easier. The OTDR works on wave propagation principles to determine the fiber length, loss and where any discontinuity in the fiber exists. If you understand the principles of RADAR (or SONAR) wave propagation principles you can correlate those principles to OTDR's. You can review concepts of modules 10 (introduction to wave propagation) and 18 (RADAR principles).

The OTDR will measure the intrinsic and extrinsic losses of the fiber including loss from mated connector pairs, splices and excessive bends. In short this is accomplished by the OTDR sending a pulse of light down the fiber and all the while the pulse is being attenuated by the impurities embedded in the core scattering the light back toward the source/detector. This allows a display to graph the loss over a length. Any rapid change in the fiber continuity will result in an echo effect (reflected event) showing where connectors, breaks or the fiber end is located. The end of the fiber or other discontinuities can be read in standard (or metric) distance. Cable length markings will be helpful in determining the exact location of the reflected event. In some cases bending losses (if extreme) in an optical fiber can be viewed in the trace of the OTDR. The OTDR creates a map-like snap shot of what is occurring within the fiber being tested. If you have this snap shot stored (documented) electronically or on paper it can be used as a troubleshooting aide by comparing traces. The tech can use the stored image to compare to the current circumstance this will help identify the fault area. The following is a more detailed description of an OTDR.

How an OTDR Works

The OTDR measures the amount of Rayleigh backscatter to determine the loss over the length. The loss caused by the impurities in the core will show loss over the length. Connector pairs and splices will also affect fiber performance and this can be seen in the trace. The loss displayed is expressed in decibels on the vertical plane. Distance is displayed on the horizontal plane. The figures below 5-1 and 5-2 show the basic block diagram of a standard OTDR, a functional block diagram of a fiber / cable run and a representative display of an OTDR trace.

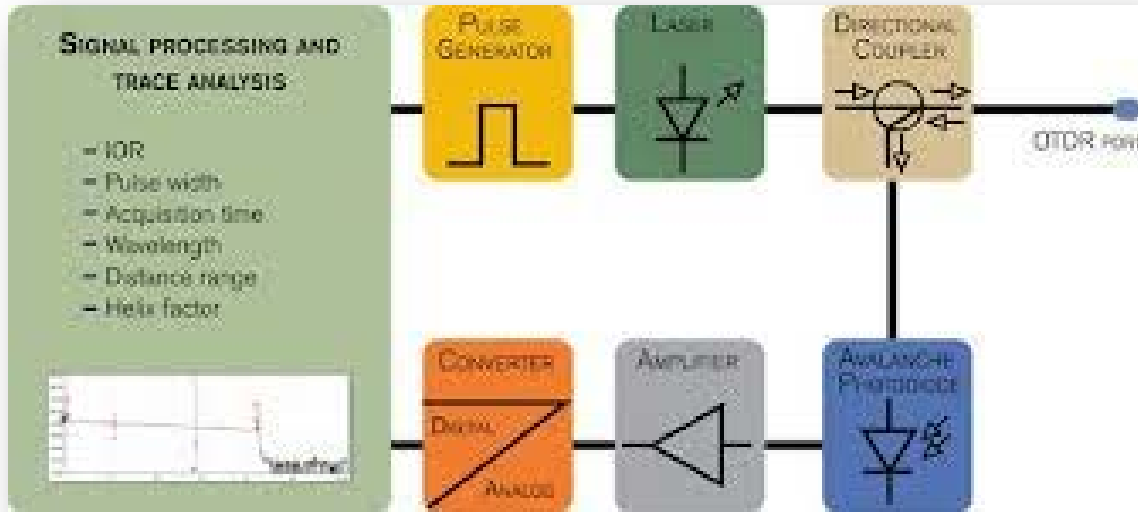

Figure 5-1. - Block diagram of an OTDR

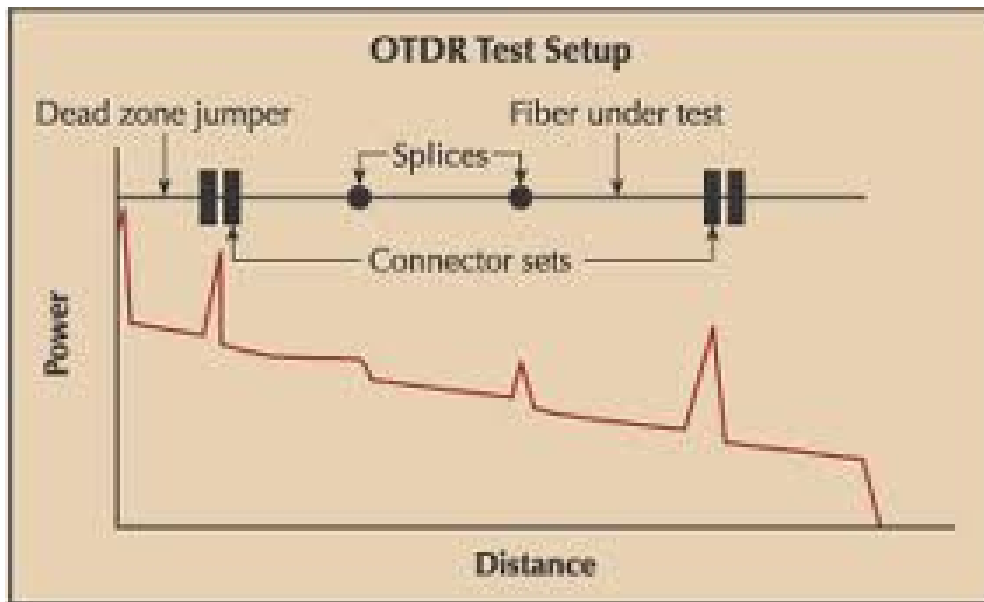

Figure 5-2. - Sample OTDR trace and topology diagram

As the power (light) is launched into the fiber it is reflected down through the core by bouncing off the core cladding interface. As the pulse of light is guided through the fiber it is also being attenuated from the density changes within the core. As it is attenuated it is also being scattered in all directions, even back towards the source. As the detector output is sampled moment to moment the power loss from the absorption and scattering will be plotted on the presentation screen.

The screen presentation will then display a slight loss in power over the length showing loss over the length. This gradual loss of power (slope) displayed on the horizontal axis of the trace is known as the power floor. The power floor is the result of the light impacting small density changes in the core of the glass. See figure 5-3.

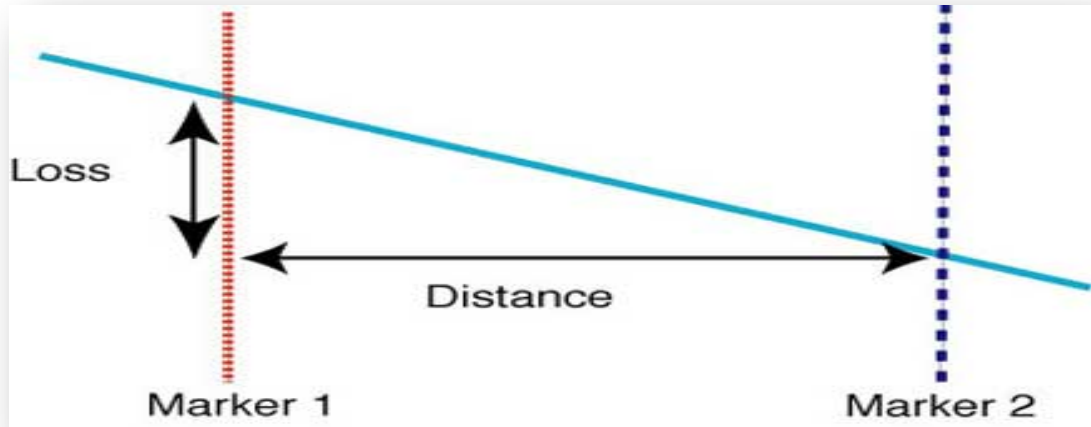

Figure 5-3. - Power floor

In order to measure the fiber length accurately there are several adjustments that need to be made on the OTDR set up menu. Pulse Width, Wavelength, Range, Index of Refraction (IOR) and Backscatter Coefficient will need to be selected by the technician to obtain the best view of the fiber under test.

The OTDR is equipped with an embedded laser. When the laser light is pulsed into the cable being tested an initial reflection at the output port will be displayed on the left of the OTDR display screen. This is caused by the initial density change by the small air gap between connectors. The displayed reflection is called the output pulse. It is also known as a Fresnel reflection. Dependent on how the technician has configured the OTDR settings and the fiber length being tested the output pulse will typically range from one nano-second to one-hundred nano-seconds in duration.

The output power of the OTDR is adjusted by the selecting the output Pulse Width (in nano-seconds). Shorter fibers need less power (shorter output pulse). The result of using a shorter pulse width is increased resolution. However the length of fiber that can be shot accurately is reduced. This type of resolution is referred to as spatial resolution represented in figure 5-4.

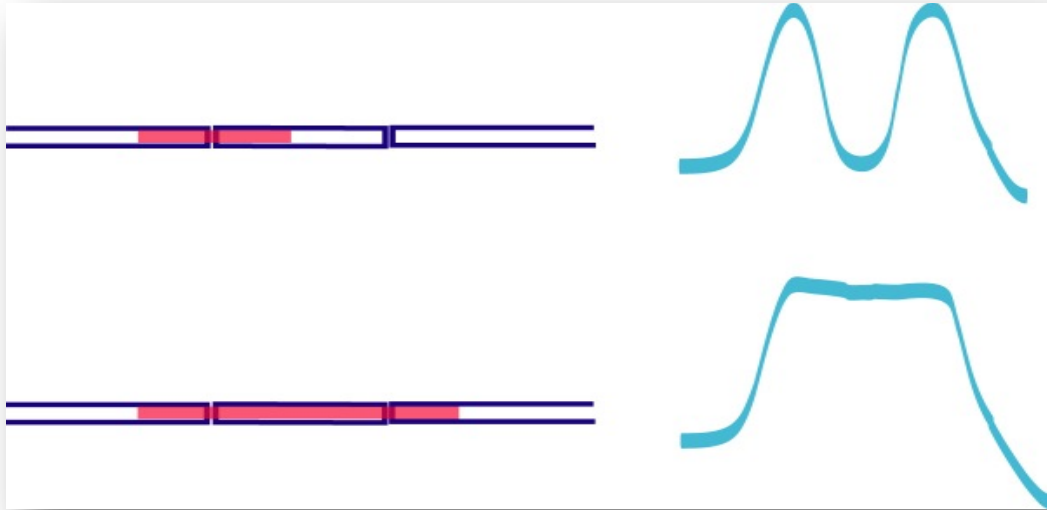

Figure 5-4. - Spatial resolution - short versus long pulse width

The time and distance represented between the leading and trailing edge of the pulse is referred to as a deadzone. The deadzone (shaded in grey) in figure 5-5 represents the recovery time of the detector, like the recovery of a human eye from a camera flash. The duration of the output pulse will determine the length of the deadzone. The deadzone is discussed in terms of a distance (horizontal scale). For instance, if the output pulse is 20 nano-seconds the deadzone will be approximate two meters/ six feet of the trace length.

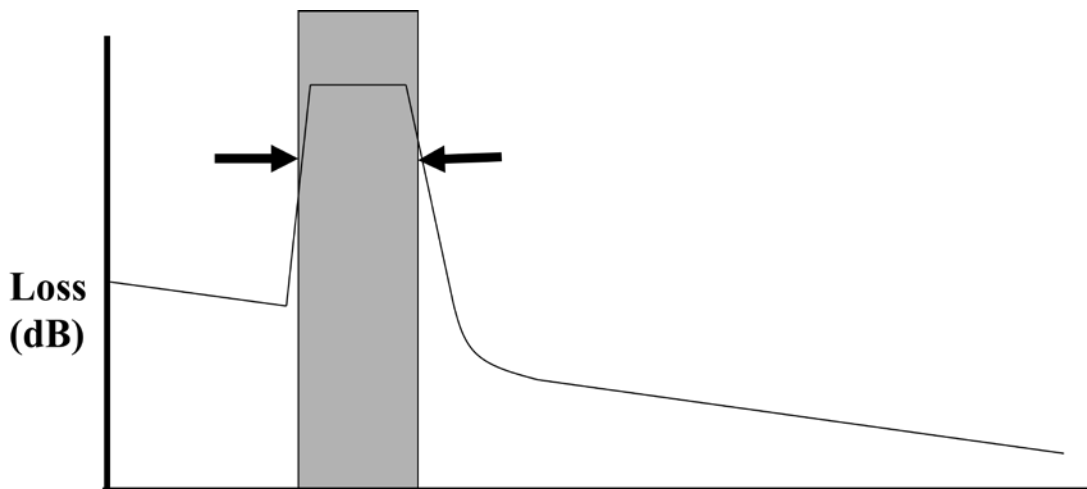

Figure 5-5. - Sample Deadzone

The display on the vertical plane is measured in dB. The light scattered back to the OTDR is representative of the output pulse and the loss in the fiber. As previously

stated the technician can change the length of the output pulse but also the number of pulses averaged resolution. This resolution is known as spatial resolution.

Another type of resolution is Data Sampling resolution. Data sampling resolution is a result of the technician settings of the front panel. It can be specifically chosen or automatically set by the other front panel programming of the OTDR unit. Data sampling in a nut shell is how often (expressed in distance) the detector will sample and display the Rayleigh backscatter to produce the power floor.

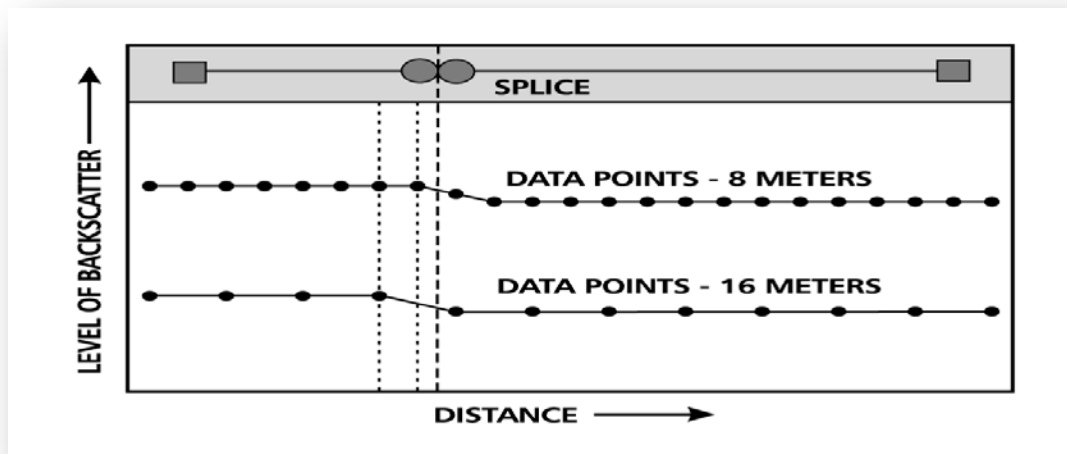

Figure 5-6. - Data sampling resolution

The total distance displayed is a direct result of the Range selected. The general rule of thumb is twice the distance of the fiber under test. For example if the fiber under test is 250 meters then a minimum of a 500 meter range should be selected. It is important to see the fiber end at the end of the OTDR trace. The end can be identified by a significant drop in the horizontal plane known as the power floor. The large loss in the power floor is the end of the fiber, commonly referred to as the beginning of the noise floor.

On the OTDR screen there are a finite number of data points depicted. Typically there are 52,000 data points displayed on the OTDR screen. If the range selected represents 80 kilometers then 52,000 data points are stretched across that range. If the display represents a one kilometer range then 52,000 data points are squeezed into that distance. See figure 5-6, the more data points in a given distance the better the resolution.

In addition to pulse width and range selection the technician should test the fiber run at the systems operating wavelength. This will help to assess the attenuation over the length of the fiber, see figure 5-7. As stated earlier in this chapter it is possible a fiber will work at one wavelength and not at another. So it is important to test at the systems operating the systems operating wavelength.



Figure 5.7. - Loss using two wavelengths over the same fiber

The Index of Refraction (N), of the fiber under test needs to be set. The OTDR set up menu will allow you to set the IOR as close to the manufacturers known IOR as possible. Typically IOR for shipboard fiber will be in between 1.46 and 1.49. If the IOR is not known the Mil-Std-2042() part six gives guidance. The accuracy of the length is inversely proportional to the IOR selected. For example the fiber will appear to be shorter if a higher IOR is used than the actual IOR of the fiber being tested. So the longer the fiber run or the more your IOR input is off the less accurate length measurements will be displayed if your IOR is not properly set.

Each of the above OTDR adjustments primarily concerns the technician with the horizontal plane of the display, in other words the loss over the length. The Backscatter coefficient is factored in the vertical plane. In common language the backscatter coefficient is the detector sensitivity. If it too sensitive the backscatter power level will be so great that the power floor cannot be seen from the reflective events. If not sensitive enough the display may show a noise floor after the output pulse. Familiarization with the particular OTDR on hand will help you select the correct level of backscatter coefficient.

Once the gear is set up, cleaned and the setup is complete the technician must connect to the fiber run to be tested. To connect to the Cable Under Test (CUT) the technician will use another type of MQJ when using an OTDR, called a “launch cable” to mate to the CUT. The launch cable is typically 50 meters long and is attached at the front end of a link that will be tested using an OTDR. A launch cable is attached to the output port of the OTDR then to the point from where the fiber will be tested. The launch cable may be referred to in some texts as a deadzone eliminator, deadzone fiber, pulse suppressor, or a 50 meter long measurement quality jumper. Regardless of its name it is always best to use a launch cable of known length that will validate your test set up and prohibits excessive ghost events.

An event is either reflected or non-reflected as shown in figure 5-8. A reflective event is a “pulse” that is apparent in the power floor. They are primarily caused by air gaps in between connector end face, poor polishing, or dirt. Reflected events may also be caused by mechanical splices and fiber ends. Non-reflected events are caused by immediate fiber losses as a result of excessive bends or fusion splices. Non-reflected events are presented in the display power floor as a sudden decrease in reflected power.

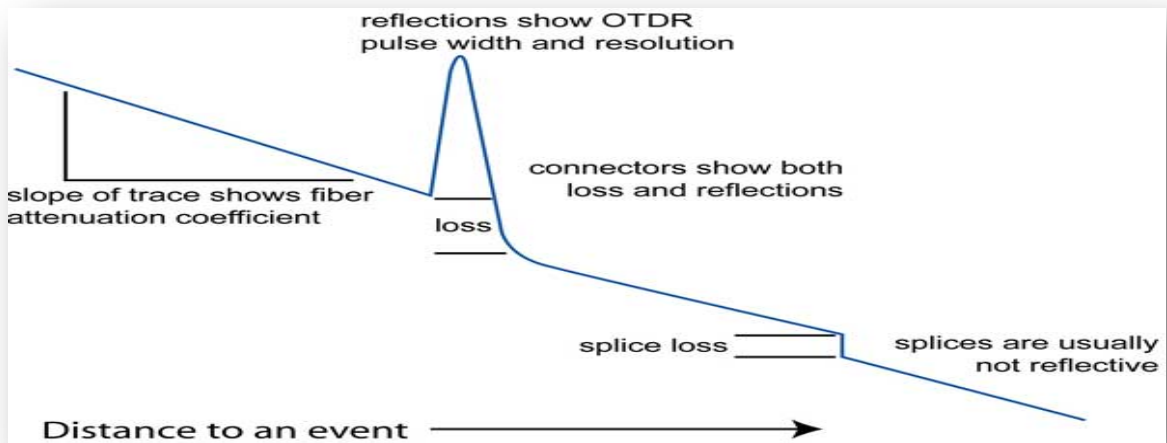

Figure 5.8. - Events, loss and power floor

A ghost event is a product of relative high reflectance, in other words reflections of reflections, shown in figure 5-9. For example the reflected light from a mated pair of connectors causes the reflected event on the trace to occur but if excess power is reflected off the OTDR on the initial reflection a secondary pulse from the initial reflection causes another pulse to be displayed. It will be visible at exact multiples of the initial reflection even into the noise.

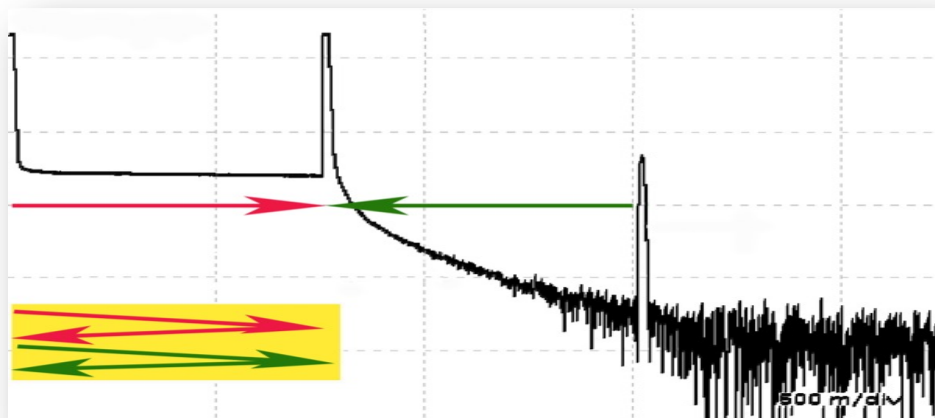

Figure 5.9. - Example of Ghost event

Finer Points of OTDR Use

Now that you have a basic understanding of the OTDR some of the finer points of measurement can be discussed. As mentioned the OTDR measures the level of backscatter but it also measures the reflectance from the events. Reflectance is the amount of light returned to the OTDR from where two fibers are joined by connectors or splices. See figure 5-10.

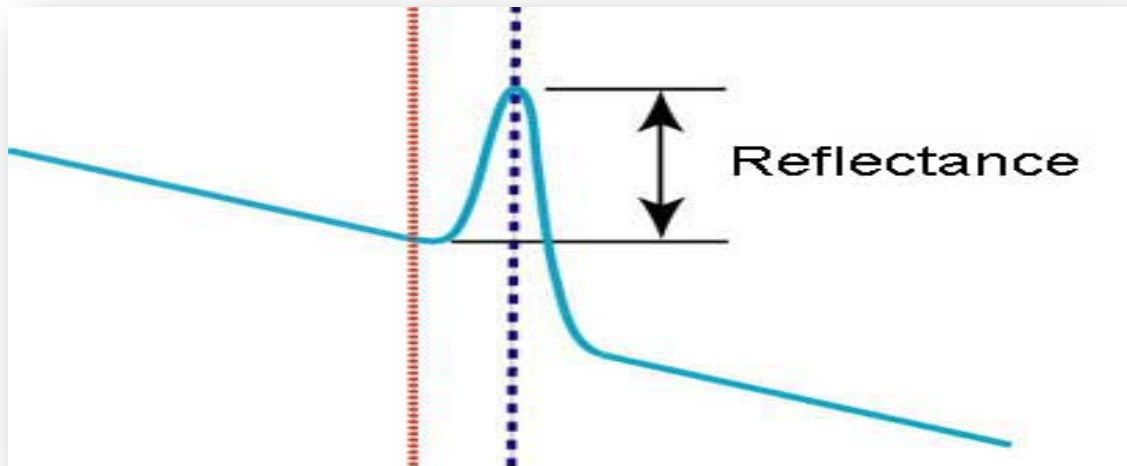

Figure 5.10. - Reflectance

Reflectance is a relative measurement to assess where the losses are greatest in comparison to the rest of the trace or a historical trace from the same fiber. In other words it can be used in comparative trace assessments.

In a nut shell the OTDR will allow the technician to document with a trace picture the overall performance of a fiber run. To assess where the connectors, splices and the ends of the fibers are located and the relative amount of power lost throughout the entire run.

Storage capacity of the OTDR is productive for affirmation of an installation or to collect data on a fiber. It can be used to compare two or more traces when troubleshooting. The specific storage capacity of the OTDR in use may allow various storage devices to copy and paste when comparing old to new or good to bad traces. The operating technician can compare traces at various wavelengths when looking excessive losses caused by excessive bends.

For example, you may recall that long wavelengths are more susceptible to bending stresses than shorter wavelengths. Comparing two traces of the same fiber shot at different wavelengths may reveal bending losses that were not there upon initial installation. These types of losses are caused by changes or forces applied to the cable

plant after the installation was complete and tested.

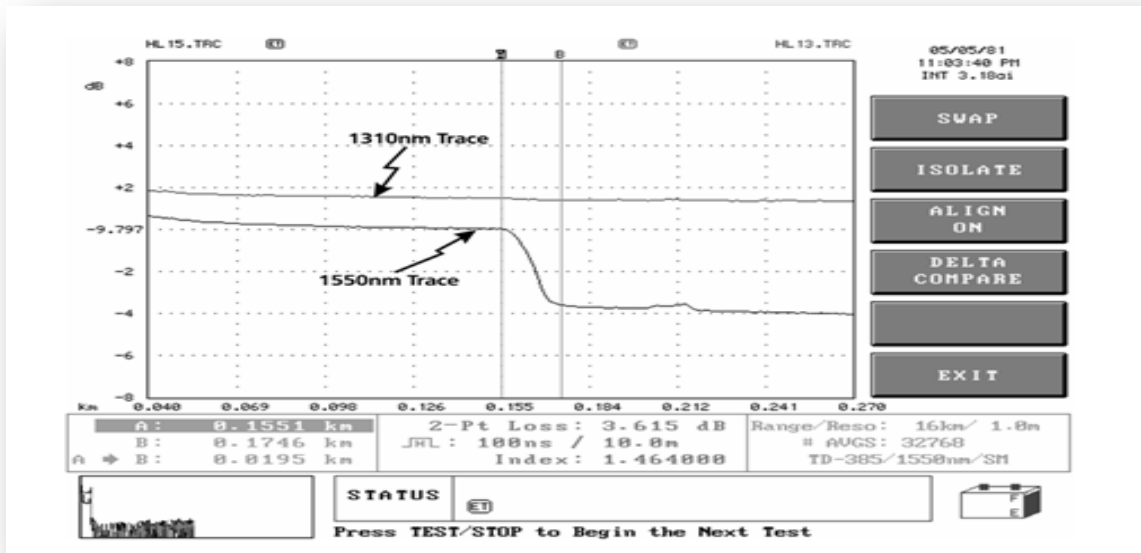

Figure 5.11. - Bending loss

In figure 5-11, the same single mode fiber was tested at both 1310 nm and 1550 nm wavelengths demonstrating a loss at the longer wavelength. You can also see in the lower left hand corner the actual traces with a large noise floor. The OTDR display was adjusted using the horizontal and vertical control values to focus in on the fiber point of concern.

More on a Launch Cables

As stated earlier a launch cable at the beginning of the run assures the OTDR user of a known good optical path and the reduction of ghosts in the power floor. Another good way to use a launch cable is to attach a second launch cable at the end of the trace. This is known as a receive cable. When the technician can see the trace with the additional 50 meter length at the end of the fiber under test not only can they be certain they are connected to the correct fiber but also the power is passing through the last junction.

The circumstances as to when the technician will use the OTDR or the OLTS to measure losses are unique. A rule of thumb is, if the optical fiber being tested is less than 50 meters long use the OLTS. The reason for this is the reflectance (Ghosting) from the power on the launch would be so great that it makes it difficult to affectively measure the trace.

Optical Talk Set

An Optical Talk Set (aka fiber optic talk set) made be found with your command test equipment. The talk set works similar to a “walkie talkie” where the push to talk

switch allows your voice to be converted to an electrical signal and then to light and converted on the other end back to audio. These are helpful in communication when salt and pepper lines and phones are not available. The talk set will work only if there is continuity in the fiber being tested; in this regard use of the optical test confirms the fiber being used has continuity.

Industry wide many other types of test equipment are available but may not be part of the ships test equipment outfit. You may also find that some test gear will have more than one function and have other modules or modes that can be switched to fortify your testing arsenal. For instance an OLTS may have a function to test Optical Return Loss (ORL) and can be used to measure Coupled Power Ratio (CPR). Other variations may give you an OTDR with built in talk sets or VFL's and power meters. You will have to get with your command Electronics Material Officer (EMO) to confirm your ready access to test gear.

Q.12 OLTS measure loss in which units of measure?

Q.13 What is typically used in a SOVT for pass/fail criteria?

Q.14 What is the name of the light reflected to the OTDR from impurities in the core that show loss over length?

Q.15 (True or False) The OTDR displays loss on the vertical plane.

Q. 16 What adjustments may be made to set up the OTDR for accurate measurements?

Q. 17 OTDR power output is adjusted by what operating parameter?

Q. 18 An output pulse of 20 ns have an approximate deadzone of how many meters/feet?

Q. 19 What are two types of OTDR resolution?

Q. 20 The large drop off of power at the end of the fiber trace is typically referred to as the?

- Q. 21 What wavelength should the fiber be tested at?*
- Q. 22 Will a cable appear to be shorter or longer, if an IOR, larger than the cable's actual IOR is entered into the OTDR setup?*
- Q.23 How long is the typical launch cable used with an OTDR?*
- Q.24 Events on an OTDR are either reflective or _____.*
- Q. 25 What are ghost reflection a result of?*
- Q. 26 The optical talk set will a allow you to communicate and it confirms the fiber has good_____.*
- Q. 27 Does a mandrel/mode filter increase or decrease the number of modes within the launch fiber?*

MEASUREMENTS

Launch Conditions

Fiber optic test measurements require accuracy and repeatability. One factor in having consistent fiber optic test results is having a reliable light source. The process of emitting optical power into the fiber is known as the Launch condition. The more consistent and precise the condition is, the better the launch condition. Having a controlled launch condition will help achieve high quality test measurements. The launch condition is the operational acceptance of the number of modes of light that will be transmitted to the core of the fiber from the source. For years it was only important to the technician just to get light in the fiber and hope it drove the response of the receiver. With bandwidths exceeding 10 GB this is no longer the case.

The Mandrel/mode filter is widely used to reduce the number of modes entering the fiber under test. A mode filter is a specific diameter dowel. The diameter of the mandrel/mode filter is dependent upon the core of the fiber being tested. A Single mode filter is typically 6-9mm (standard pencil size), multimode 50 micron 25 mm (inch), and multimode 62.5 micron 20mm (.75 inch). The filter works simply by wrapping the launch MQJ several times around the filter, thereby bending the fiber consistently,

resulting in reduced high order modes exiting the launch fiber. The filter is used to set the reference power and will remain in place during testing.

Although using a mandrel/mode filter to achieve a good Coupled Power Ratio (CPR) is still widely used the Encircled Flux (EF) launch is the latest method to control the number of modes being launched to the fiber under test. The analysis of EF maintains the optical power in a given radius of the core of the fiber. Although this is important practical concerns must be met before concerning the specific launch condition for a specific test. Since EF components are new to the market they are mostly used external to the test launch equipment. It is very difficult to keep the EF modules from physically shifting during tests. For now EF launches are dysfunctional in fleet testing but may one day be the norm. So for now mandrel/mode filters are our best solution to reducing the number of modes launched into the core if the light source does not meet current navy standards for CPR.

Index matching gel/fluid/material is typically a liquid use to match optical properties of the glass. It is still used in the Rotary Mechanical Splice (RMS) that is still found on AGEIS platforms but, it has become obsolete and AT&T quit manufacturing them in 1997. Typically index matching gel is used in mechanical splices and crimp on No-Epoxy-No-Polish (NENP) style connectors to reduce back reflections and loss caused from the air gap between the optical surfaces.

Practical Concerns of Testing

Reliable testing is a result of proper training, calibrated test equipment, hazards, fiber geometry, quality couplers and adapters. Hazards to quality test results are a product of dirt, unstable light source, sub-par end face polish on the cable under test or MQJ's, and excessive bends to name a few. Fiber optics testing reveals catastrophic or microscopic failures. One thing for sure proper

Blown Optical Fiber Cable Testing

As learned in chapter 3 Blown Optical Fiber is essentially hollow tubes of plastic traversing a ship, penetrating decks and bulkheads. If BOF cabling is not properly installed and tested the fiber may not be able to be installed. This will be costly in hours of rework and materials. Another serious concern, considering the route a BOF cable takes improper installation may cause cascading flooding. Proper BOF cable installation and testing are critical to the ships primary mission. The Mil-Std-2042() gives guidance on all BOF testing. Each of the various tests for BOF cable testing will be discussed in the following discussion.

As with conventional cable a visual test is the first step to quality control. The visual test is conducted to find obvious damage. It should be conducted upon acceptance and post installation. Beyond that, specific equipment will be required to conduct the other BOF cable tests. Each of these tests can be conducted on one segment of a cable or the entire run to be populated with fiber.

The second BOF test is the Ball Bearing (BB) Test. All the BOF tube tests, including the BB test require specific low pressure (compressed) air equipment of certain

quality, specified by the manufacturer of the BOF cabling. This test is required by the cable manufacturer to ensure that the BOF tubes are free and clear before introducing fibers into them. This test is recommended by the Navy.

If the BB does not pass it is understood the tube is blocked (crushed or kinked) and must be cleared to blow fiber into the tube. As the BB passes from one end to the other of the tube under test the technician will have confidence that the fiber will pass through that same route. The assurance of a seamless installation comes from using a BB that is a slightly larger diameter than the fiber or bundles being installed in the tube.

The next test is the Pressurization Test. This test validates the tube or tubes are air-tight and validate the O-ring seals on the couplers. Again this test is required by the manufacturer but only recommended by the Navy prior to installing the fiber. The pressurization test can be used to confirm the path or route of the cabling before blowing the fiber into the tube(s). It is designed to confirm the integrity of the tubes of each link in the path.

Similar to the pressurization test is the BOF Tube Seal Verification Test. This is the only test made mandatory by the Navy as it is a damage control verification that the tubes are air/water tight after installation is completed. It is mandated after the installation of the furcation unit (refer to chapter 3) that this test must be performed. The Seal Verification Test ascertains the tube(s) are terminated and sealed properly.

Each of the BOF tube procedures mentioned above is similar regardless of the manufacturer of the BOF tube cabling. The exact process requires specific knowledge and hands on training. Most of these procedures will be conducted in a maintenance availability or depot level facility. The unique safety concerns of BOF that require the technician to be exceptionally cautious. There are personal and equipment safety concerns for each and every fiber optic test mentioned above.

The vigilant technician will use operational risk assessments to reduce optical and other physical hazards that can harm personnel or otherwise damage equipment. Fiber optic safety practices can be found in Mil-Std documents, ANSI standards, OSHA standards and specific equipment manuals. These safety practices should not be overlooked and each test may challenge the best of well-intentioned technicians to keep our forces safe.

Fiber Optic Plant Records

Fiber optic plant installation requires certain testing documents. These may include Plant drawings, Loss budget, link loss, topology test results OTDR print outs. Each platform, ship, aircraft, shore and each command may have different requirements. Regardless of how it is documented the ambitious fiber optic maintenance technician and command will benefit to find these installation documents for emergent repairs if they are not already at ready access. Depending on the command these SOVT documents may be found in the ships technical library, Engineering offices, Combat system offices, technical spaces or at a depot level facility. These documents are part of the ships history and have a practical value at your command. SOVT Documents can aid in the

restoration of a ships system and shorten the time and effort to troubleshoot a fiber optic plant. Plant records are valuable simply to compare and contrast past and current test measurements.

Q.28 What is the result of using index matching gel?

Q.29 Is the Ball bearing test a mandatory test for blown optical fiber installation?

Q.30. What Blown Optical Fiber cable test ensures that the microducts are free and clear of obstructions?

Q.31 Is the Tube Seal Verification test a mandatory test for blown optical fiber installation?

Q.32 What installation test documents may be found as part of your command fiber optic plant history?

SUMMARY

Fiber optic cable testing is not a fire and forget process. It requires observation of the most minute details of the fiber optic cable, connectors, test processes, safety and documentation. Our nations' security is a result of proper training, maintenance and test procedures. This requires every maintenance technician to be familiar with fiber optic technology and the nuances at the command level. The technology of fiber optics will continue to evolve and become more intricate and widespread. As this goes the sailor, engineer and depot level maintenance technician will find their knowledge, skills and reliability critical to the meeting worldwide commitments of our forces.

ANSWERS TO QUESTIONS Q1. THROUGH Q32.

- A.1 *To ensure all fiber optic weapons, communication, engineering and navigation equipment perform as designed.*
- A.2 *Mil-Std-2042()*
- A.3 *Assures system dependability*
- A.4 *Physical discontinuities including bends, nicks cuts, abrasions, thin spots, wrinkles, burn marks, missing markings labels and labels on the outside jacket of the cable*
- A.5 *Not necessarily*
- A.6 *Dim or no light*
- A.7 *VFL and OLD*
- A.8 *Two, light source and detector*
- A.9 *Inspect, clean and reinspect*
- A10 *Oils, film residues and powdery coatings*
- A11 *Reduced network downtime, reduced troubleshooting, optimized signal performance and prevention of network damage*
- A.12 *Watts, dBm and dB*
- A.13 *Loss budget*
- A. 14 *Rayleigh backscatter*
- A.15 *True.*
- A. 16 *Pulse Width, Wavelength, Range, Index of Refraction and Backscatter Coefficient*
- A. 17 *Pulse width*
- A.18 *Two meters/ Six feet*
- A. 19 *Spatial and Data Sampling resolution*
- A. 20 *Noise floor*
- A. 21 *The systems operating wavelength*
- A. 22 *Shorter*
- A. 23 *50 meters long*

- A.24 *Non-reflective*
- A. 25 *High reflectance, typical of connector of mated pairs.*
- A. 26 *Continuity*
- A.27 *Decrease*
- A. 28 *reduces back reflections and loss*
- A. 29 *No*
- A. 30 *Ball bearing test*
- A.31 *Yes.*
- A. 32 *Plant drawings, loss budget, link loss, topology test results and OTDR print outs.*

CHAPTER 6

OPTICAL SOURCES AND FIBER OPTIC TRANSMITTERS

LEARNING OBJECTIVES

After you finish this chapter, you should be able to do the following:

1. Explain the principal properties of an optical source and fiber optic transmitter.
2. Discuss the optical emission properties of semiconductor light-emitting diodes (LEDs), laser diodes (LDs), and vertical-cavity surface-emitting laser (VCSELs).
3. Describe the operational differences between surface-emitting LEDs (SLEDs), edge-emitting LEDs (ELEDs), super luminescent diodes (SLDs), laser diodes, and vertical-cavity surface-emitting laser (VCSELs).
4. Describe typical fiber optic transmitter packages.

INTRODUCTION TO OPTICAL SOURCES & FIBER OPTIC TRANSMITTERS

Chapter 1 taught you that a fiber optic data link has three basic functions. One function is that a fiber optic data link must convert an electrical signal to an optical signal permitting the transfer of data along an optical fiber. The fiber optic device responsible for that signal conversion is a fiber optic transmitter.

A fiber optic transmitter is a hybrid device. It converts electrical signals into optical signals and launches the optical signals into an optical fiber. A fiber optic transmitter consists of an interface circuit, a source drive circuit, and an optical source. The interface circuit accepts the incoming electrical signal and processes it to make it compatible with the source drive circuit. The source drive circuit intensity modulates the optical source by varying the current through the source.

An optical source converts electrical energy (current) into optical energy (light). Light emitted by an optical source is launched, or coupled, into an optical fiber for transmission. Fiber optic data link performance depends on the amount of optical power (light) launched into the optical fiber. This chapter attempts to provide an understanding of light-generating mechanisms within the main types of optical sources used in fiber optics.

Q1. What are the three parts of a fiber optic transmitter?

Q2. Which part of a fiber optic transmitter converts the processed electrical signal to an optical signal?

Optical Source Properties

The development of efficient semiconductor optical sources, along with low-loss optical fibers, led to substantial improvements in fiber optic communications. Semiconductor optical sources have the physical characteristics and performance properties necessary for successful implementations of fiber optic systems. It is desirable that optical sources:

- Be compatible in size to low-loss optical fibers by having a small light-emitting area capable of launching light into fiber
- Launch sufficient optical power into the optical fiber to overcome fiber attenuation and connection losses allowing for signal detection at the receiver
- Emit light at wavelengths that minimize optical fiber loss and dispersion. Optical sources should have a narrow spectral width to minimize dispersion
- Allow for direct modulation of optical output power
- Maintain stable operation in changing environmental conditions (such as temperature)
- Cost less and be more reliable than electrical devices, permitting fiber optic communication systems to compete with conventional systems

Semiconductor optical sources suitable for fiber optic systems range from inexpensive light-emitting diodes (LEDs) to more expensive semiconductor lasers. Semiconductor LEDs and laser diodes (LDs) are the principal light sources used in fiber optics.

Operating Wavelength

Fiber optic communication systems operate in the 850-nm, the 1300-nm, and the 1550-nm wavelength windows. Semiconductor sources are designed to operate at wavelengths that minimize optical fiber absorption and maximize system bandwidth. By designing an optical source to operate at specific wavelengths, absorption from impurities in the optical fiber, such as hydroxyl ions (OH⁻), can be minimized. Maximizing system

bandwidth involves designing optical fibers and sources that minimize chromatic and intermodal dispersion at the intended operational wavelength.

Initially, the material properties of semiconductor optical sources provided for optical emission in the 850-nm wavelength region. An 850-nm operational wavelength avoids fiber absorption loss from OH⁻ impurities near the 900-nm wavelength. Light sources for 850-nm systems were originally semiconductor LEDs and lasers. Currently, most 850-nm systems use LEDs as a light source. LEDs operating at 850-nm provide sufficient optical power for short-distance, low-bandwidth systems. However, multimode fiber dispersion, the relatively high fiber attenuation, and the LED's relatively low optical output power prevent the use of these devices in longer-distance, higher bandwidth systems.

The first development allowing the operational wavelength to move from 850 nm to 1300 nm was the introduction of multimode graded-index fibers. Multimode graded-index fibers have substantially lower intermodal dispersion than multimode step-index fibers. Systems operating at 850 nm cannot take full advantage of the fiber's low intermodal dispersion because of high chromatic dispersion at 850 nm. However, the use of multimode graded-index fibers allow 850-nm LEDs to operate satisfactorily in short-distance, higher bandwidth systems.

Following the enhancements in multimode fiber design, next generation LEDs were designed to provide optical emission in the 1300-nm region. Multimode graded-index fiber systems using these LEDs can operate over longer distances and at higher bandwidths than 850-nm systems. Longer distances and higher bandwidths are possible because fiber material losses and dispersion are significantly reduced at the 1300-nm region.

Advances in single mode fiber design and construction sped the development of semiconductor LEDs and LDs optimized for single mode fibers. Single mode fibers have very low dispersion values. However, existing LEDs were unable to focus and launch sufficient optical power into single mode fibers for long-haul, very high-bandwidth communication systems. New semiconductor LEDs and LDs capable of operating with single mode fibers at 1300 nm were developed to take advantage of single mode fiber's very low value of dispersion. Additionally, LEDs and LDs operating at 1550 nm were developed to take advantage of the fiber's lowest loss.

Q3. LEDs operating at 850 nm provide sufficient optical power for short-distance, low-bandwidth multimode systems. List three conditions that prevent the use of LEDs in longer distance, higher bandwidth multimode systems.

Q4. Why can multimode graded-index fiber 1300-nm systems using LEDs operate over longer distances and at higher bandwidths than 850-nm systems?

SEMICONDUCTOR LIGHT-EMITTING DIODES AND LASER DIODES

Semiconductor LEDs emit incoherent light. Spontaneous emission of light in semiconductor LEDs produces light waves that lack a fixed-phase relationship. Light waves that lack a fixed-phase relationship are referred to as incoherent light. Spontaneous emission of light is discussed in more detail later in this chapter. The use of LEDs in single mode systems is severely limited because they emit unfocused incoherent light. Even LEDs developed for single mode systems are unable to launch sufficient optical power into single mode fibers for many applications. LEDs are the preferred optical source for multimode systems because they can launch sufficient power at a lower cost than semiconductor LDs.

Semiconductor LDs emit coherent light. LDs produce light waves with a fixed-phase relationship (both spatial and temporal) between points on the electromagnetic wave. Light waves having a fixed phase relationship are referred to as coherent light. Stimulated emission of light is discussed later in this chapter. Since semiconductor LDs emits more focused light than LEDs, they are able to launch optical power into both single mode and multimode optical fibers. However, LDs are usually used only in single mode fiber systems because they require more complex driver circuitry and cost more than LEDs.

Optical power produced by optical sources can range from microwatts (μW) for LEDs to tens of milliwatts (mW) for semiconductor LDs. However, it is not possible to effectively couple all the available optical power into the optical fiber for transmission.

The amount of optical power coupled into the fiber is the relevant optical power. It depends on the following factors:

- The angles over which the light is emitted
- The size of the source's light-emitting area relative to the fiber core size
- The alignment of the source and fiber
- The coupling characteristics of the fiber (such as the NA and the refractive index profile)

Typically, semiconductor lasers emit light spread out over an angle of 10 to 15 degrees. Semiconductor LEDs emit light spread out at even larger angles. Coupling losses of several decibels can easily occur when coupling light from an optical source to a fiber, especially with LEDs.

Source-to-fiber coupling efficiency is a measure of the relevant optical power. The coupling efficiency depends on the type of fiber that is attached to the optical source. Coupling efficiency also depends on the coupling technique. Source-to-fiber coupling involves centering a flat fiber-end face over the emitting region of the light source. If the fiber end face is directly placed over the source emitting region, it is referred to as butt coupling. If the source's output light pattern is larger than the fiber's acceptance pattern, source-to-fiber coupling efficiency may be improved by placing a small lens between the source and fiber. Lensing schemes improve coupling efficiency when coupling both LEDs and LDs to optical fibers.

Q5. Semiconductor LEDs emit incoherent light. Define incoherent light.

Q6. Which semiconductor sources (LD or LED) emit more focused light and are capable of launching sufficient optical power into both single mode and multimode fibers?

Q7. The amount of optical power coupled into an optical fiber depends on what four factors?

Semiconductor Material and Device Operating Principles

Understanding optical emission in semiconductor lasers and LEDs requires knowledge of semiconductor material and device properties. Providing a complete description of semiconductor properties is beyond the scope of this introductory manual. In this chapter we only discuss the general properties of semiconductor LEDs and LDs.

Semiconductor sources are diodes, with all of the characteristics typical of diodes. However, their construction includes a special layer, called the active layer, which emits photons (light particles) when a current passes through the layer. The particular properties of the semiconductor are determined by the materials used and the layering of the materials within the semiconductor. Silicon (Si) and gallium arsenide (GaAs) are the two most common semiconductor materials used in electronic and electro-optic devices. In some cases other elements, such as aluminum (Al), indium (In) and phosphorus (P), are added to the base semiconductor material to modify the semiconductor properties. These elements are called dopants.

Current flowing through a semiconductor optical source causes it to produce light. An in-depth description of either of the two processes by which this occurs is beyond the scope of this module. However, we discuss elementary descriptions in the following paragraphs.

LEDs generally produce light through spontaneous emission when a current is passed through them. Spontaneous emission is the random generation of photons within

the active layer of the LED. The emitted photons move in random directions. Only a certain percentage of the photons exit the semiconductor and are coupled into the fiber. Many of the photons are absorbed by the LED materials and the energy dissipated as heat. This process causes the light output from an LED to be incoherent, have a broad spectral width, and have a wide output pattern.

Laser diodes are much more complex than LEDs. Laser is an acronym for light amplification by the stimulated emission of radiation. Laser diodes produce light through stimulated emission when a current is passed through them. Stimulated emission describes how light is produced in any type of laser. In the laser diode, photons, initially produced by spontaneous emission interact with the laser material to produce additional photons. This process occurs within the active area of the diode called the laser cavity. The process does not affect the original photon. The stimulated photon has many of the same properties (wavelength, direction, and phase) as the original photon.

As with the LED, not all of the photons produced are emitted from the laser diode. Some of the photons are absorbed and the energy dissipated as heat. The emission process and the physical characteristics of the diode cause the light output to be coherent, have a narrow spectral width, and have a narrow output pattern.

It is important to note that in both LED and laser diodes all of the electrical energy is not converted into optical energy. A substantial portion is converted to heat. Different LED and laser diode structures convert differing amounts of electrical energy into optical energy.

Q8. What are the two most common semiconductor materials used in electronic and electro-optic devices?

Q9. What is a laser?

Q10. Describe stimulated emission.

Light-Emitting Diodes

A light-emitting diode (LED) is a semiconductor device that emits incoherent light, through spontaneous emission, when a current is passed through it. Typically LEDs for the 850-nm region are fabricated using GaAs and AlGaAs. LEDs for the 1300-nm and 1550-nm regions are fabricated using InGaAsP and InP.

The basic LED types used for fiber optic communication systems are the surface-emitting LED (SLED), the edge-emitting LED (ELED), and the super luminescent diode

(SLD). LED performance differences help link designers decide which device is appropriate for the intended application. For short-distance (0 to 3 km), low-data-rate fiber optic systems, SLEDs and ELEDs are the preferred optical source. Typically, SLEDs operate efficiently for bit rates up to 250 megabits per second (Mb/s). Because SLEDs emit light over a wide area (wide far-field angle), they are almost exclusively used in multimode systems.

For medium-distance, medium-data-rate systems, ELEDs are preferred. ELEDs may be modulated at rates up to 400 Mb/s. ELEDs may be used for both single mode and multimode fiber systems. Both SLDs and ELEDs are used in long-distance, high-data-rate systems. SLDs are ELED-based diodes designed to operate in the super luminescence mode. A further discussion on super luminescence is provided later in this chapter. SLDs may be modulated at bit rates of over 400 Mb/s.

Surface-Emitting LEDs

The surface-emitting LED (shown in figure 6-1) is also known as the Burrus LED in honor of C. A. Burrus, its developer. In SLEDs, the size of the primary active region is limited to a small circular area of 20 μm to 50 μm in diameter. The active region is the portion of the LED where photons are emitted. The primary active region is below the surface of the semiconductor substrate perpendicular to the axis of the fiber. A well is etched into the substrate to allow direct coupling of the emitted light to the optical fiber. The etched well allows the optical fiber to come into close contact with the emitting surface. In addition, the epoxy resin that binds the optical fiber to the SLED reduces the refractive index mismatch, increasing coupling efficiency.

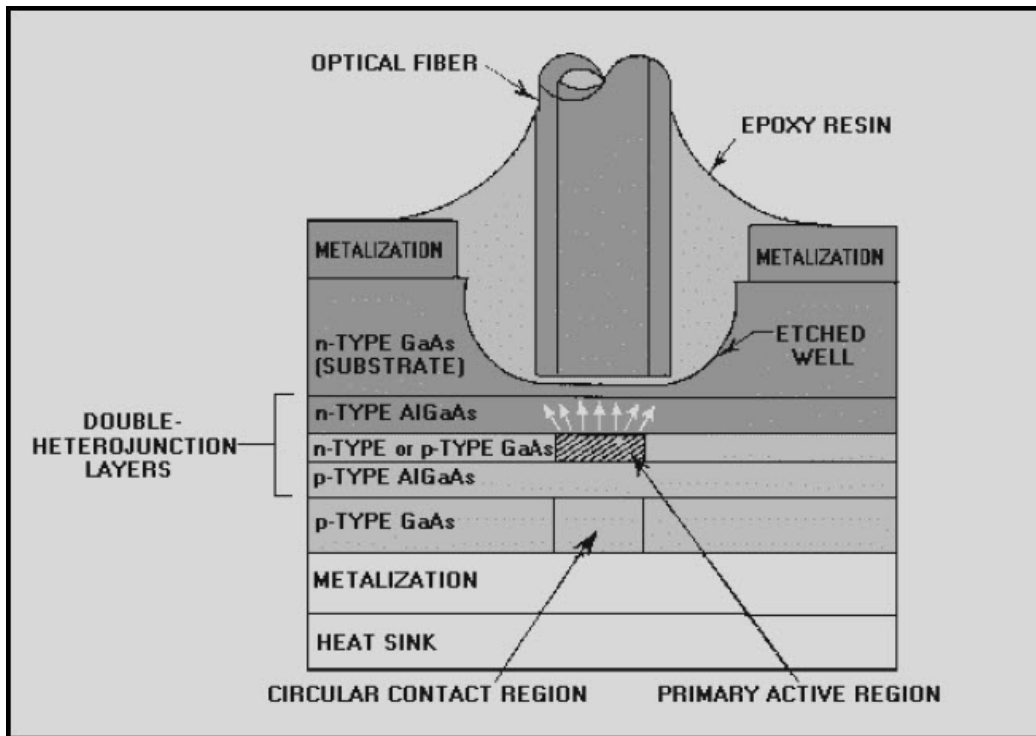

Figure 6-1. - Example of the SLED structure

Edge-Emitting LEDs

The demand for optical sources for longer distance, higher bandwidth systems operating at longer wavelengths led to the development of edge-emitting LEDs. Figure 6-2 shows a typical ELED structure. It shows the different layers of semiconductor material used in the ELED. The primary active region of the ELED is a narrow stripe, which lies below the surface of the semiconductor substrate. The semiconductor substrate is cut or polished so that the stripe runs between the front and back of the device. The polished or cut surfaces at each end of the stripe are called facets.

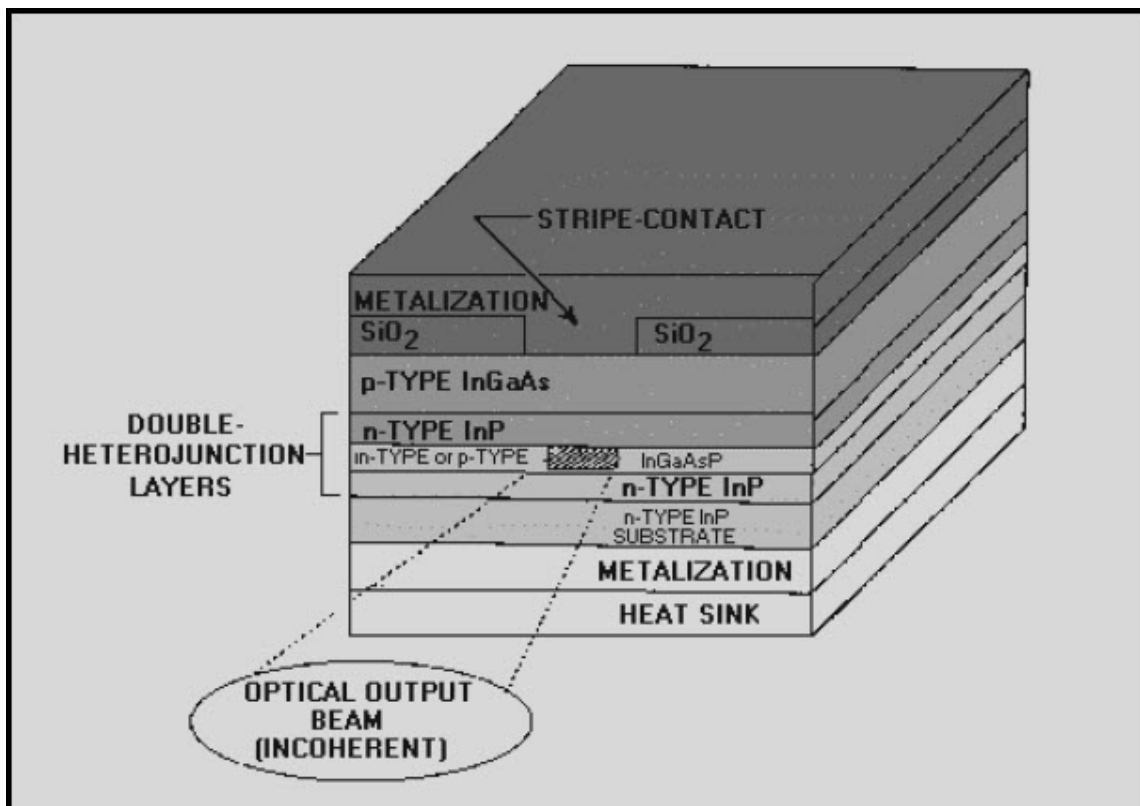

Figure 6-2. - Example of the ELED structure

In an ELED the rear facet is highly reflective and the front facet is antireflection-coated. The rear facet reflects the light propagating toward the rear end-face back toward the front facet. By coating the front facet with antireflection material, the front facet reduces optical feedback and allows light emission. ELEDs emit light only through the front facet.

ELEDs emit light in a narrow emission angle allowing for better source-to-fiber coupling. They couple more power into small NA fibers than SLEDs. ELEDs can couple enough power into single mode fibers for some applications. ELEDs emit power over a narrower spectral range than SLEDs. However, ELEDs typically are more sensitive to temperature fluctuations than SLEDs.

Laser Diodes

A laser is a device that produces optical radiation by the process of stimulated emission. It is necessary to contain photons produced by stimulated emission within the laser active region. Figure 6-3 shows an optical cavity formed to contain the emitted photons by placing one reflecting mirror at each end of an amplifying medium. One mirror is made partially reflecting so that some radiation can escape from the cavity for coupling to an optical fiber.

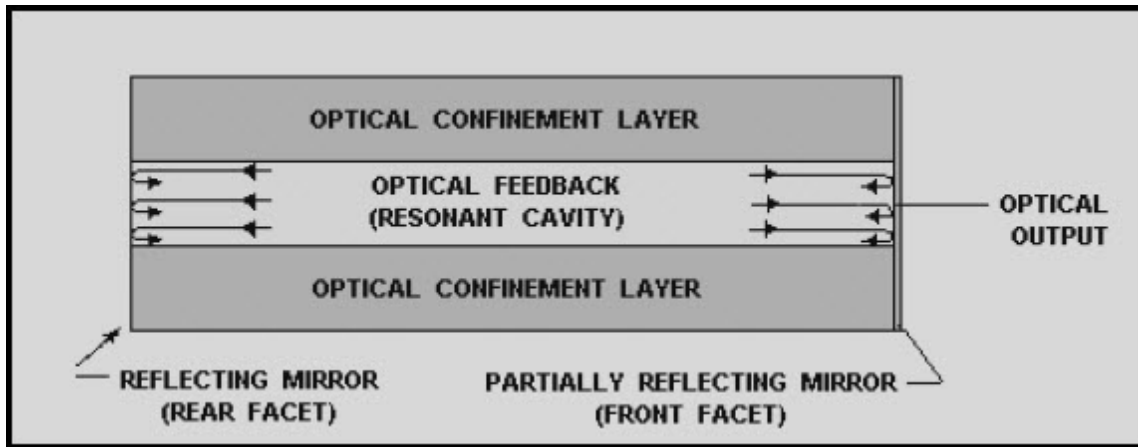

Figure 6-3. - Optical cavity for producing lasing

Only a portion of the optical radiation is amplified. For a particular laser structure, there are only certain wavelengths that will be amplified by that laser. Amplification occurs when selected wavelengths, also called laser modes, reflect back and forth through the cavity. For lasing to occur, the optical gain of the selected modes must exceed the optical loss during one round-trip through the cavity. This process is referred to as optical feedback.

The lasing threshold is the lowest drive current level at which the output of the laser results primarily from stimulated emission rather than spontaneous emission. Figure 6-4 illustrates the transition from spontaneous emission to stimulated emission by plotting the relative optical output power and input drive current of a semiconductor laser diode. The lowest current at which stimulated emission exceeds spontaneous emission is the threshold current. Before the threshold current is reached, the optical output power increases only slightly with small increases in drive current. However, after the threshold current is reached, the optical output power increases significantly with small changes in drive currents.

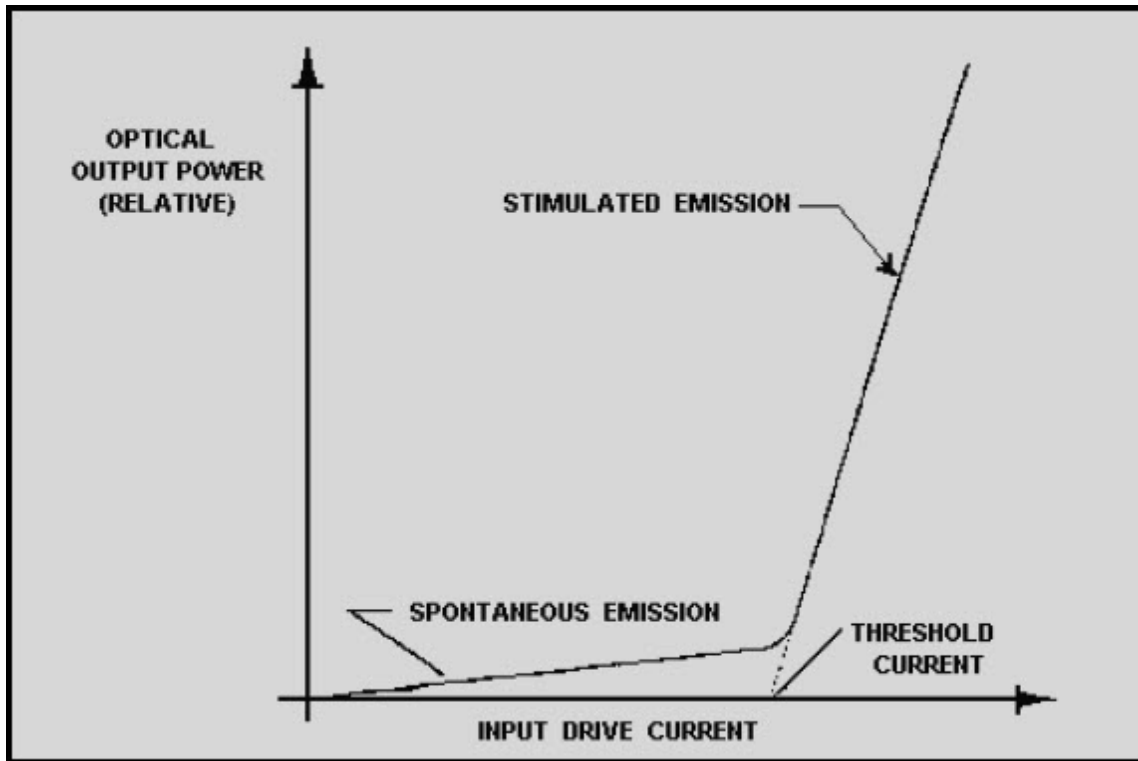

Figure 6-4. - The optical output power as a function of input drive current of a semiconductor laser diode

Many types of materials including gas, liquid, and semiconductors can form the lasing medium. However, in this chapter we only discuss semiconductor laser diodes. Semiconductor laser diodes are the primary lasers used in fiber optics. A laser diode emits light that is highly monochromatic and very directional. This means that the LD's output has a narrow spectral width and small output beam angle.

A semiconductor LD's geometry is similar to an ELED with light-guiding regions surrounding the active region. Optical feedback is established by making the front facet partially reflective. This chapter provides no diagram detailing LD structures because they are similar to ELEDs in design. The rear facet is typically coated with a reflective layer so that all of the light striking the facet is reflected back into the active region. The front facet is typically left uncoated so that most of the light is emitted. By increasing the drive current, the diode becomes a laser.

At currents below the threshold current, LDs function as ELEDs. To optimize frequency response, laser diodes are often biased above this laser threshold. As a result, in an LD fiber optic system, light is modulated between a high power level and a lower power level, but never shut off. LDs typically can be modulated at frequencies up to over 2 gigahertz (GHz). Some lasers are capable of being modulated at frequencies over 20 GHz.

There are several important differences between LDs and LEDs. One is that LEDs usually lack reflective facets and in some cases are designed to suppress reflections back into the active region. Another is that lasers tend to operate at higher drive currents to produce light. A higher driver current results in more complicated drive circuits and more heat dissipation in the device.

LDs are also much more temperature sensitive than either SLEDs or ELEDs. Increases in the laser temperature significantly reduce laser output power. Increases in laser temperature beyond certain limits result in the loss of lasing. When lasers are used in many applications, the temperature of the laser must be controlled. Typically, electronic coolers, called thermo-electric (TE) coolers, are used to cool LDs in system applications.

Super luminescent Diodes

Super luminescence occurs when the spontaneous emissions of an ELED experience gain due to higher injected currents and reflections from facets. Super luminescent diodes (SLDs) are differentiated from both conventional LEDs and LDs. Although the output is not fully coherent, SLDs emit light that consists of amplified spontaneous emissions. The spectral width and beam angle of SLDs are narrower than that of conventional LEDs and wider than that of LDs.

An SLD is, in essence, a combination of a laser and an ELED. SLDs are similar in geometry to lasers but have no built-in optical feedback mechanism required by laser diodes for stimulated emission to achieve lasing. SLDs have structural features similar to those of ELEDs that suppress the lasing action by reducing the reflectivity of the facets. SLDs are essentially highly optimized ELEDs.

While SLDs operate like ELEDs at low current levels, their output power increases superlinearly and the spectral width narrows at high currents. Optical gain resulting from the higher injection currents causes the superlinear power increase and narrowing of the spectral width.

The advantages of SLDs over conventional LEDs include higher coupled power, narrower spectral width, and greater bandwidths. The disadvantages include nonlinear power-current characteristics, higher temperature sensitivity, and lower reliability.

Vertical-Cavity Surface-Emitting Laser

The vertical-cavity surface emitting laser, or VCSEL, is a type of semiconductor laser diode with laser beam emission perpendicular from the top surface, contrary to conventional edge-emitting semiconductor lasers (also in-plane lasers) which emit from surfaces formed by cleaving the individual chip out of a wafer.

VCSELs are semiconductor lasers, more specifically laser diodes with a monolithic laser resonator, where the emitted light leaves the device in a direction perpendicular to the chip surface. The laser resonator consists of mirrors parallel to the wafer surface with an active region consisting of one or more quantum wells for the laser light generation in between.

The resonator (cavity) is realized with two semiconductor Bragg mirrors (distributed Bragg reflector [DBR] lasers). Between those, there is an active region (gain structure) with (typically) several quantum wells and a total thickness of only a few micrometers.

The planar DBR-mirrors consist of layers with alternating high and low refractive indices. Each layer has a thickness of a quarter of the laser wavelength in the material, yielding intensity reflectivities above 99%.

In most cases, the active region is electrically pumped with a few tens of milliwatts and generates an output power in the range from 0.5–5 mW, or higher powers for multimode devices. The current is often applied through a ring electrode, through which the output beam can be extracted, and the current is confined to the region of the resonator mode using electrically conductive (doped) mirror layers with isolating material around them.

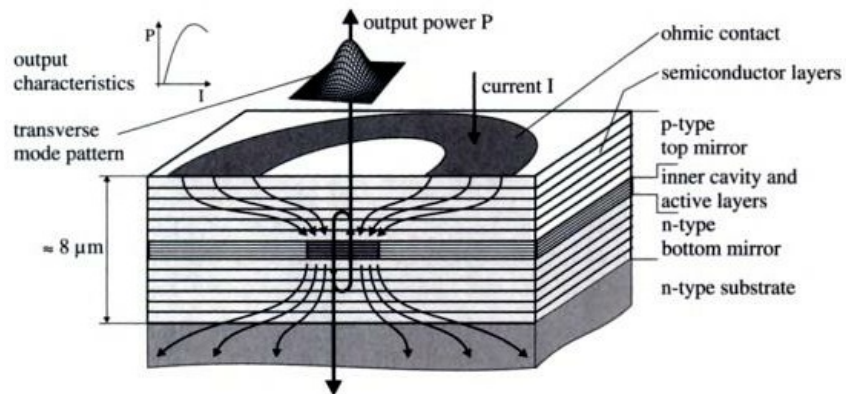

Figure 6-5. - Schematic of layer structure of a VCSEL

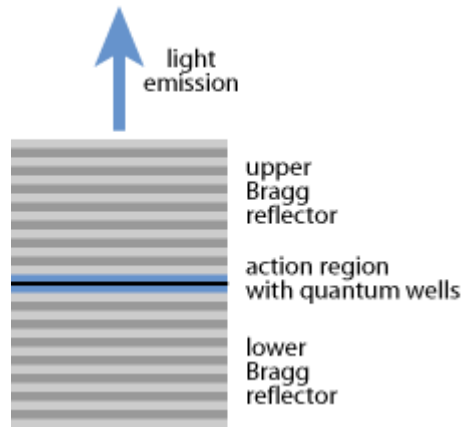

Figure 6-6. - Schematic of gain structure of a VCSEL

VCSELs can have a good beam quality only for fairly small mode areas (diameters of a few microns) and are thus limited in terms of output power. For larger mode areas, the excitation of higher-order transverse modes cannot be avoided; this is a consequence of the extremely small resonator length of only a few microns, and the difficulty in homogeneously pumping a larger active region with a ring electrode. The short resonator, however, also makes it easy to achieve single-frequency operation, even combined with some wavelength tunability. Also, VCSELs can be modulated with high frequencies, making them useful for optical fiber communications.

In addition to the high beam quality of low-power VCSELs, an important aspect is the low beam divergence, compared with that of edge-emitting laser diodes, and the symmetric beam profile. This makes it easy to collimate the output beam with a simple lens, which does not have to have a very high numerical aperture.

The most common emission wavelengths of VCSELs are in the range of 750–980 nm (often around 850 nm), as obtained with the GaAs/AlGaAs material system. However, longer wavelengths of e.g. 1300, 1550 or even beyond 2000 nm (as required for, e.g., gas sensing) can be obtained with dilute nitrides (GaInNAs quantum wells on GaAs) and from devices based on indium phosphide (InAlGaAsP on InP).

Much higher powers can be generated with VCSEL arrays. A 2-D VCSEL array with several thousand emitters can emit several hundred watts. The effective beam quality is then of course much reduced, as the emission comes from a larger area while the beam divergence equals that of a single emitter. Such devices can generate hundreds of watts of output power with a high efficiency and can thus compete with diode bars and even diode stacks based on edge-emitting semiconductor lasers.

An important practical advantage of VCSELs, as compared with edge-emitting semiconductor lasers, is that they can be tested and characterized directly after growth, i.e. before the wafer is cleaved. This makes it possible to identify quality problems early

on, and to react immediately. Furthermore, it is possible to combine a VCSEL wafer with an array of optical elements (e.g. collimation lenses) and then dice this composite wafer instead of mounting the optical elements individually for every VCSEL. This allows for cheap mass production of laser products. Another interesting feature of VCSELs is the long lifetime, as there is no facet which can be damaged by high optical intensities.

VCSELs also have many applications. Due to the short resonator round-trip time, VCSELs can be modulated with frequencies well in the gigahertz range. This makes them useful as transmitters for optical fiber communications. For short-range communications, 850-nm VCSELs are used in combination with multimode fibers. A data rate of e.g. 10 Gbit/s can be reached over a distance of a few hundred meters.

An application area which was developed later, but has acquired a large market volume, is that of computer mice. A laser mouse with a VCSEL as light source can have a high tracking precision combined with low electricity consumption, as is important for battery-powered devices.

Another prominent field of application is gas sensing with wavelength-tunable VCSELs. Such devices are built e.g. as Microelectromechanical systems (MEMS) VCSELs, having a separate output coupling mirror the position of which can be tuned via thermal expansion, electrostatic forces, or a piezoelectric element. In this area, VCSELs partially compete with distributed feedback lasers (DFB lasers), but offer a smaller drive current, a wider tuning range and a higher modulation speed. Optical oxygen sensors are of particular importance, because an absorption line at 760 nm is in reach of GaAs-based VCSELs, whereas longer-wavelength VCSELs which could be used for detecting water vapor, methane, or carbon dioxide need some further development before widespread use.

Q11. What are the three basic LED types?

Q12. Which types of LEDs are the preferred optical sources for short-distance, low-data-rate fiber optic systems?

Q13. What are facets?

Q14. What is lowest current at which stimulated emission exceeds spontaneous emission in a semiconductor laser called?

Q15. Describe the output of a laser diode.

Q16. Which type of optical source usually lacks reflective facets and in some cases are designed to suppress reflections back into the active region?

Q17. Which type of optical source tends to operate at higher drive currents to produce light?

Q18. Are the effects of temperature changes on LDs more or less significant than for LEDs?

Q19. Specify the mechanism that SLDs lack that is required by laser diodes to achieve lasing.

Q20. What is a VCSEL?

Q21. Describe the VCSEL's device structure.

Q22. What type of semiconductor substrate materials are VCSELs made of for wavelengths from 750 nm to 1300 nm?

FIBER OPTIC TRANSMITTERS

As stated previously, a fiber optic transmitter is a hybrid electro-optic device. It converts electrical signals into optical signals and launches the optical signals into an optical fiber. A fiber optic transmitter consists of an interface circuit, a source drive circuit, and an optical source. The interface circuit accepts the incoming electrical signal and processes it to make it compatible with the source drive circuit. The source drive circuit intensity modulates the optical source by varying the current through it. The optical signal is coupled into an optical fiber through the transmitter output interface.

Although semiconductor LEDs and LDs have many similarities, unique transmitter designs result from differences between LED and LD sources. Transmitter designs compensate for differences in optical output power, response time, linearity, and thermal behavior between LEDs and LDs to ensure proper system operation. Nonlinearities caused by junction heating in LEDs and mode instabilities in LDs necessitate the use of linearizing circuits within the transmitter in some cases.

Fiber optic transmitters using LDs require more complex circuitry than transmitters using LEDs. The basic requirement for digital systems is for drive circuitry to switch the optical output on and off at high speeds in response to logic voltage levels at the input of the source drive circuit. Because LDs are threshold devices, LDs are supplied with a bias just below the threshold in the off state. This bias is often referred to as prebias. One reason for prebiasing the LD is to reduce the turn-on delay in digital systems.

Most LD transmitters contain output power control circuitry to compensate for temperature sensitivity. This circuitry maintains the LD output at a constant average value by adjusting the bias current of the laser. In most cases LED transmitters do not contain output power control circuitry. LD and LED transmitters may also contain cooling devices to maintain the source at a relatively constant temperature. Most LD transmitters either have an internal thermo electric cooler or require a relatively controlled external temperature. Because LDs require more complex circuitry than LEDs, fiber optic transmitters using LDs are more expensive.

Transmitter output interfaces generally fall into two categories: optical connectors and optical fiber pigtails. Optical pigtails are attached to the transmitter optical source. This pigtail is generally routed out of the transmitter package as a coated fiber in a loose buffer tube or a single fiber cable. The pigtail is either soldered or epoxied to the transmitter package to provide fiber strain relief. The buffer tube or single fiber cable is also attached to the transmitter package to provide additional strain relief.

The transmitter output interface may consist of a fiber optical connector. The optical source may couple to the output optical connector through an intermediate optical fiber. One end of the optical fiber is attached to the source. The other end terminates in the transmitter optical output connector. The optical source may also couple to the output optical connector without an intermediate optical fiber. The optical source is placed within the transmitter package to launch power directly into the fiber of the mating optical connector. In some cases lenses are used to more efficiently couple light from the source into the mating optical connector.

Q23. How does the source drive circuit intensity modulate the source?

Q24. What is a prebias?

Q25. Is the drive circuitry generally more complex for an LED or a laser diode? Why?

Q26. What are the two types of output interfaces for fiber optic transmitters?

Fiber Optic Transmitter Packages

Fiber optic transmitters come in various sizes and shapes. The least complex fiber optic transmitters are typically packaged in transistor outline (TO) cans or hybrid microcircuit modules in dual in-line packages (DIPs). These simple transmitters may require separate circuitry in the system equipment to provide an acceptable input signal to the transmitter. More complex fiber optic transmitters are available that have some or all of the signal conditioning circuitry integrated into the package. These transmitters typically are packaged in hybrid microcircuit modules in either DIP or butterfly lead packages, circuit cards, or complete stand-alone fiber optic converters. Stand-alone fiber optic converters and circuit cards generally contain sources in either TO cans or one of the hybrid microcircuit packages. For commercial applications, the most popular transmitter packages are the TO can and the DIP hybrid microcircuit.

Fiber Optic Transmitter Applications

Fiber optic transmitters can be classified into two categories: digital and analog. Digital transmitters produce two discrete optical power levels. These levels are essentially on and off with the exception that some light is emitted in the off state by some transmitters. Analog transmitters continuously vary the output optical power level as a function of the input electrical signal.

Digital Applications

Different types of fiber optic transmitters are used for different digital applications. For each specific application, the link data rate, transmission length, and operating environment influence the source type, center wavelength, spectral width, and package type chosen.

For low-data-rate applications, fiber optic transmitters generally use LEDs operating in either the 850-nm or 1300-nm window as their source. For the lowest data rates (0 to 20 megabits per second (Mbps)), sources tend to operate in the 850-nm window. For moderate data rates (50 to 200 Mbps), sources tend to operate in the 1300-nm window. Laser sources are almost never used in low-data-rate applications. Laser sources are only used when extremely high transmitter output powers are required in the application. The packages found in low-data-rate applications include all the package types discussed earlier.

For high-data-rate applications, most fiber optic transmitters use laser diodes as sources. The sources typically operate in either the 1300-nm or 1550-nm windows. Most high-data-rate applications use LDs as the optical source and operate in the 1300-nm region. Almost all 1550-nm systems use an LD as the optical source. 1550-nm transmitters are usually only used in the extremely long distance high-data-rate applications (undersea links, etc.). High-data-rate transmitters are generally hybrid microcircuit modules or complete circuit cards. Almost all high-data-rate transmitters contain power control circuitry. Depending upon the application, high-data-rate transmitters may contain TE coolers.

Q27. List five common fiber optic transmitter packages.

Q28. What type of source is typically used in low-data-rate digital applications?

Q29. Why would a laser diode be used in a low-data-rate digital application?

Q30. What type of source is generally used in high-data-rate digital applications?

Analog Applications

Different types of fiber optic transmitters are also used for different analog applications. For each specific application, analog signal type, transmission length, and operating environment influence the source type, center wavelength, spectral width, and package type chosen.

For low-frequency applications, analog fiber optic transmitters generally use LEDs operating in either the 850-nm or 1300-nm window. Typical low frequency applications are analog audio and single channel video systems. For these systems, sources tend to operate in the 850-nm window. For moderate frequency applications, sources tend to operate in the 1300-nm window. These types of systems include multi-channel analog audio and video systems as well as frequency modulated (FM) systems. Laser sources are almost never used in low- or moderate-frequency analog applications. The main reason for this is the added circuit complexity that laser sources require. Laser sources are only used if extremely high transmitter output powers are required in the application. Most low-frequency analog transmitters are hybrid microcircuit modules, circuit cards, or stand-alone boxes.

For high-frequency applications, analog fiber optic transmitters use laser diodes as sources. Typical high frequency applications are cable television trunk line and raw radar remote applications. The LDs typically operate in either the 1300-nm or 1550-nm

windows. 1550-nm transmitters are typically used in cable television trunk line applications. Other applications may use either 1300-nm or 1550-nm LDs. High frequency transmitters are predominately circuit cards, but some hybrid microcircuit modules are also used. All high frequency analog transmitters contain TE coolers as well as linearization and power control circuitry.

Q31. Why are LEDs preferred over laser diodes for low- and moderate-frequency analog applications?

SUMMARY

Now that you have completed this chapter, let's review some of the new terms, concepts, and ideas that you have learned. You should have a thorough understanding of these principles before moving on to chapter 7.

A **FIBER OPTIC TRANSMITTER** is a hybrid electro-optic device. It converts electrical signals into optical signals and launches the optical signals into an optical fiber.

An **OPTICAL SOURCE** converts electrical energy (current) into optical energy (light).

The principal **LIGHT SOURCES** used in fiber optics are semiconductor light-emitting diodes (LEDs) and laser diodes (LDs).

SEMICONDUCTOR LD's emit coherent light. Light waves having a fixed-phase relationship are referred to as coherent light.

SEMICONDUCTOR LED'S emit incoherent light. Light waves that lack a fixed-phase relationship are referred to as incoherent light.

The **RELEVANT OPTICAL POWER** is the amount of optical power coupled into the fiber. It depends on the angle over which the light is emitted, the size of the source's light-emitting area relative to the fiber core size, the alignment of the source and fiber, and the coupling characteristics of the fiber (such as the NA and the refractive index profile).

SOURCE-TO-FIBER COUPLING EFFICIENCY is a measure of the relevant optical power.

SILICON (Si) and **GALLIUM ARSENIDE (GaAs)** are the two most common semiconductor materials used in electronic and electro-optic devices.

In a semiconductor device, **PHOTONS (LIGHT)** are emitted when current flows through the active area.

SPONTANEOUS EMISSION occurs when photons are emitted in a random manner. Spontaneous emission produces incoherent light.

STIMULATED EMISSION occurs when a photon interacts with the laser material to produce additional photons.

A **LIGHT-EMITTING DIODE (LED)** is a semiconductor device that emits incoherent light, through spontaneous emission, when a current is passed through it. The basic LED types used for fiber optic communication systems are the **SURFACE-EMITTING LED (SLED)**, the **EDGE-EMITTING LED (ELED)**, and the **SUPERLUMINESCENT DIODE (SLD)**.

In **SURFACE-EMITTING LED'S (SLEDs)**, the size of the primary active region is limited to a small circular area of 20 μm to 50 μm in diameter. The active region is the portion of the LED where photons are emitted. SLEDs usually emit more total power into the air gap at the fiber interface than an ELED, but they do not launch as much power into the fiber. SLEDs also tend to emit power over a wider spectral range than ELED.

EDGE-EMITTING LED'S (ELEDs) emit light in a narrow emission angle allowing for better source-to-fiber coupling. They couple more power into small NA fibers than SLEDs. The polished or cut surfaces at each end of the ELED active stripe are called **FACETS**.

SUPERLUMINESCENCE occurs when the spontaneous emissions of an ELED experience gain due to higher injected currents and reflections from facets.

SUPERLUMINESCENT DIODES (SLDs) are similar in geometry to lasers but have no built-in optical feedback mechanism required by laser diodes for stimulated emission to achieve lasing. Although the output is not fully coherent, super luminescent diodes (SLDs) emit light that consists of amplified spontaneous emissions. The spectral width and beam angle of SLDs are narrower than that of conventional LEDs and wider than that of LDs.

The **ADVANTAGES** of **SLDs** over conventional LEDs include higher coupled power, narrower spectral width, and greater bandwidths. The **DISADVANTAGES** include nonlinear power-current characteristics, higher temperature sensitivity, and lower reliability.

A **LASER** is a device that produces optical radiation using stimulated emission rather than spontaneous emission. Laser is an acronym for light amplification by the stimulated emission of radiation.

The vertical-cavity surface-emitting laser, or **VCSEL**, is a type of semiconductor laser diode with laser beam emission perpendicular from the top surface, contrary to conventional edge-emitting semiconductor lasers (also in-plane lasers) which emit from surfaces formed by cleaving the individual chip out of a wafer.

A **DISTRIBUTED BRAGG REFLECTOR (DBR)** is a reflector used in waveguides, such as optical fibers. It is a structure formed from multiple layers of alternating materials with varying refractive index, or by periodic variation of some characteristic (such as height) of a dielectric waveguide, resulting in periodic variation in the effective refractive index in the guide.

The **LASING THRESHOLD** is the lowest drive level at which the output of the laser results primarily from stimulated emission rather than spontaneous emission.

The **THRESHOLD CURRENT** is the lowest current at which stimulated emission exceeds spontaneous emission.

A **LASER DIODE** is a semiconductor diode that emits coherent light by lasing. The LD's output has a narrow spectral width and small output beam angle.

TRANSMITTER OUTPUT INTERFACES fall into two categories: optical connectors and optical fiber pigtails.

FIBER OPTIC TRANSMITTERS using LDs require more complex circuitry than transmitters using LEDs.

Because **LDs** are threshold devices, LDs are supplied with a bias just below the threshold in the off state. This bias is often referred to as a prebias.

The least complex **FIBER OPTIC TRANSMITTERS** are typically packaged in transistor outline (TO) cans or hybrid microcircuit modules in dual inline packages (DIPs).

More complex **FIBER OPTIC TRANSMITTERS** typically are packaged in hybrid microcircuit modules in either DIP or butterfly lead packages, circuit cards, or complete stand-alone fiber optic converters.

FIBER OPTIC TRANSMITTERS can be classified into two categories: digital and analog.

DIGITAL TRANSMITTERS modulate the fiber optic source between two discrete optical power levels. These levels are essentially on and off with the exception that some light is emitted in the off state by some transmitters.

ANALOG TRANSMITTERS continuously vary the output optical power level as a function of the input electrical signal.

For **LOW-DATA-RATE APPLICATIONS** (0 to 20 Mbps), fiber optic transmitters generally use LEDs operating in either the 850-nm or 1300-nm window.

For **MODERATE-DATA-RATE APPLICATIONS** (50 to 200 Mbps), fiber optic transmitters generally use LEDs operating in the 1300-nm window.

For **HIGH-DATA-RATE APPLICATIONS**, most fiber optic transmitters use laser diodes as sources.

LASER SOURCES are almost never used in low- or moderate-frequency analog applications because LED sources require much less complex circuitry.

ANSWERS TO QUESTIONS Q1 THROUGH Q31.

- A1. *Interface circuit, source drive circuit, and an optical source.*
- A2. *The optical source.*
- A3. *Multimode fiber dispersion, the relatively high fiber attenuation, and the LED's relatively low optical output power.*
- A4. *Longer distances and higher bandwidths are possible because fiber material losses and dispersion are significantly reduced at the 1300-nm region.*
- A5. *Light waves that lack a fixed-phase relationship.*
- A6. *LDs.*
- A7. *(1) The angles over which the light is emitted. (2) The size of the source's light-emitting area relative to the fiber core size. (3) The alignment of the source and fiber. (4) The coupling characteristics of the fiber (such as the NA and the refractive index profile).*
- A8. *Silicon and gallium arsenide.*
- A9. *A laser is a device that produces optical radiation using stimulated emission rather than spontaneous emission.*
- A10. *A photon initially produced by spontaneous emission in the active region interacts with the laser material to produce additional photons.*
- A11. *Surface-emitting LEDs (SLEDs), edge-emitting LEDs (ELEDs), and super luminescent diodes (SLDs).*
- A12. *SLEDs and ELEDs.*
- A13. *Cut or polished surfaces at each end of the narrow active region of an ELED.*
- A14. *Threshold current.*
- A15. *The LD's output has a narrow spectral width and small output beam angle.*
- A16. *LED.*
- A17. *Laser.*

- A18. *More.*
- A19. *SLDs have no built-in optical feedback mechanism.*
- A20. *The vertical-cavity surface emitting laser, or VCSEL, is a type of semiconductor laser diode with laser beam emission perpendicular from the top surface, contrary to conventional edge-emitting semiconductor lasers which emit from surfaces formed by cleaving the individual chip out of a wafer.*
- A21. *VCSELs are semiconductor lasers, more specifically laser diodes with a monolithic laser resonator, where the emitted light leaves the device in a direction perpendicular to the chip surface. The laser resonator consists of mirrors parallel to the wafer surface with an active region consisting of one or more quantum wells for the laser light generation in between.*
- A22. *VCSELs in the range of 750–980nm are obtained with the GaAs/AlGaAs material system. Wavelengths of 1300nm can be obtained with GaInNAs quantum wells on GaAs or InAlGaAsP on InP.*
- A23. *By varying the current through the source.*
- A24. *A current applied in the laser off state just less than the threshold current.*
- A25. *For a laser diode. The laser diode transmitter generally contains output power control circuitry and may contain a TE cooler and some circuitry associated with the TE cooler.*
- A26. *Optical connectors and optical fiber pigtails.*
- A27. *TO can, DIP, butterfly lead microcircuits, circuit cards, and stand-alone optical fiber converters.*
- A28. *LED.*
- A29. *When extremely high transmitter output powers are required.*
- A30. *Laser diode.*
- A31. *LEDs require less complex circuitry than lasers.*

CHAPTER 7

OPTICAL DETECTORS AND FIBER OPTIC RECEIVERS

LEARNING OBJECTIVES

After you finish this chapter, you should be able to do the following:

1. Explain the principal properties of an optical detector and fiber optic receiver.
2. Detail semiconductor optical detector performance and capability requirements necessary for the successful implementation of fiber optic systems.
3. List the main components of a fiber optic receiver.
4. Discuss receiver sensitivity, dynamic range, and other key operational parameters used to define receiver performance.

INTRODUCTION TO OPTICAL DETECTORS AND FIBER OPTIC RECEIVERS

Chapter 6 taught you that a fiber optic transmitter is an electro-optic device capable of accepting electrical signals, converting them into optical signals, and launching the optical signals into an optical fiber. The optical signals propagating in the fiber become weakened and distorted because of scattering, absorption, and dispersion. The fiber optic device responsible for converting the weakened and distorted optical signal back to an electrical signal is a fiber optic receiver.

A **fiber optic receiver** is an electro-optic device that accepts optical signals from an optical fiber and converts them into electrical signals. A typical fiber optic receiver consists of an optical detector, a low-noise amplifier, and other circuitry used to produce the output electrical signal (see figure 7-1). The optical detector converts the incoming optical signal into an electrical signal. The amplifier then amplifies the electrical signal to a level suitable for further signal processing. The type of other circuitry contained within the receiver depends on what type of modulation is used and the receiver electrical output requirements.

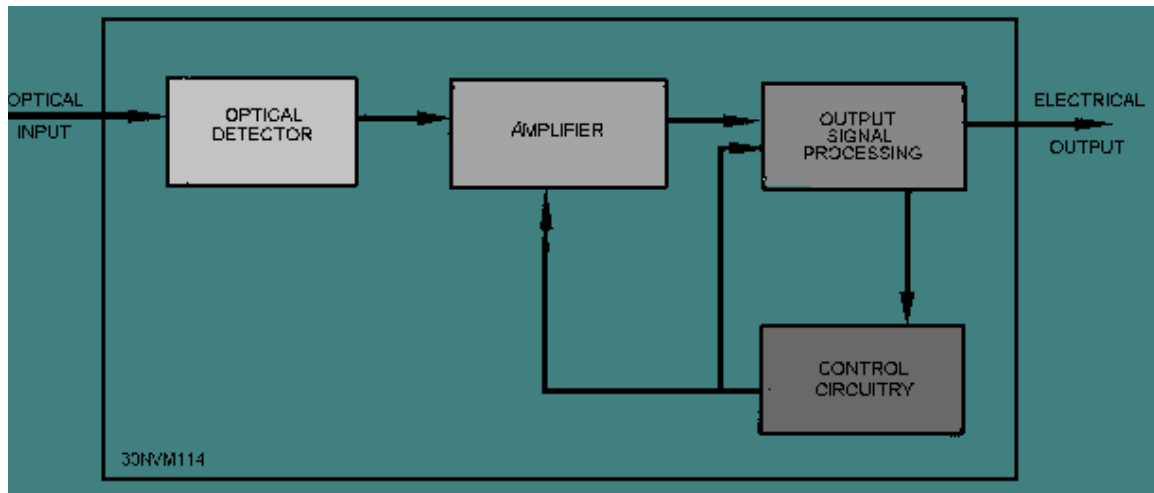

Figure 7-1. - Block diagram of a typical fiber optic receiver

Receiver spectral response, sensitivity, frequency response, and dynamic range are key receiver performance parameters that can affect overall system operation. The choice of optical detector materials and structures determines the spectral response. Silicon (Si), gallium arsenide (GaAs), and gallium aluminum arsenide (GaAlAs) are typical detector materials used for receiver operation in the 850-nm wavelength region. Germanium (Ge), indium phosphide (InP), and indium gallium arsenide (InGaAs) are examples of detector materials used for receiver operation in the 1300-nm and 1550-nm wavelength regions.

The **receiver sensitivity** is the minimum amount of optical power required to achieve a specific receiver performance. For digital transmission at a given data rate and coding, this performance is described by a maximum bit-error rate (BER). In analog systems, for a given modulation and bandwidth, it is described by a minimum signal-to-noise ratio (SNR). **Dynamic range** refers to the range of optical power levels over which the receiver operates within the specified values. It usually is described by the ratio of the maximum input power to the sensitivity. Before discussing receiver sensitivity, bandwidth, dynamic range, and frequency response in more detail, we discuss the main types of optical detectors used in fiber optics.

Q1. What is a fiber optic receiver?

Q2. Which part of the receiver amplifies the electrical signal to a level suitable for further signal processing?

Q3. Which performance parameter is the minimum amount of optical power required to achieve a specific bit-error rate (BER) in digital systems or a given signal-to-noise ratio (SNR) in analog systems?

Q4. Define receiver dynamic range.

OPTICAL DETECTORS

A **transducer** is a device that converts input energy of one form into output energy of another. An **optical detector** is a transducer that converts an optical signal into an electrical signal. It does this by generating an electrical current proportional to the intensity of incident optical radiation. The relationship between the input optical radiation and the output electrical current is given by the detector responsivity. Responsivity is discussed later in this chapter.

Optical Detector Properties

Fiber optic communications systems require that optical detectors meet specific performance and compatibility requirements. Many of the requirements are similar to those of an optical source. Fiber optic systems require that optical detectors:

- Be compatible in size to low-loss optical fibers to allow for efficient coupling and easy packaging.
- Have a high sensitivity at the operating wavelength of the optical source.
- Have a sufficiently short response time (sufficiently wide bandwidth) to handle the system's data rate.
- Contribute low amounts of noise to the system.
- Maintain stable operation in changing environmental conditions, such as temperature.

Optical detectors that meet many of these requirements and are suitable for fiber optic systems are semiconductor photodiodes. The principal optical detectors used in fiber optic systems include semiconductor positive-intrinsic-negative (PIN) photodiodes and avalanche photodiodes (APDs).

Q5. Describe the operation of an optical detector.

Q6. For efficient operation, should a detector have a high or low responsivity at the operating wavelength?

Q7. List the two principal optical detectors used in fiber optic systems.

Semiconductor Photodiodes

Semiconductor photodiodes generate a current when they absorb photons (light). The amount of current generated depends on the following factors:

- The wavelengths of the incident light and the responsivity of the photodiode at those wavelengths
- The size of the photodiode active area relative to the fiber core size
- The alignment of the fiber and the photodiode

The optical fiber is coupled to semiconductor photodiodes similarly to the way optical sources are coupled to optical fibers. Fiber-to-photodiode coupling involves centering the flat fiber-end face over the photodiode active area. This is normally done directly by butt coupling the fiber up to the photodiode surface. As long as the photodiode active area is larger than that of the fiber core, fiber-to-detector coupling losses are very low. In some cases a lens may be used to couple the fiber end-face to the detector. However, this is not typically done.

Semiconductor Material and Device Properties

The mechanism by which optical detectors convert optical power into electrical current requires knowledge of semiconductor material and device properties. As stated in chapter 6, providing a complete description of these properties is beyond the scope of this manual. In this chapter we only discuss the general properties of semiconductor PINs and APDs.

Semiconductor detectors are designed so that optical energy (photons) incident on the detector active area produces a current. This current is called a **photocurrent**. The particular properties of the semiconductor are determined by the materials used and the layering of the materials within the device. Silicon (Si), gallium arsenide (GaAs), germanium (Ge), and indium phosphide (InP) are the most common semiconductor materials used in optical detectors. In some cases aluminum (Al) and indium (In) are used as dopants in the base semiconductor material.

Responsivity

Responsivity is the ratio of the optical detector's output photocurrent in amperes to the incident optical power in watts. The responsivity of a detector is a function of the wavelength of the incident light and the efficiency of the device in responding to that wavelength. For a particular material, only photons of certain wavelengths will generate a photocurrent when they are absorbed. Additionally, the detector material absorbs some wavelengths better than others. These two properties cause the wavelength dependence in the detector responsivity. Responsivity is a useful parameter for characterizing detector performance because it relates the photocurrent generated to the incident optical power.

Q8. What are the four most common materials used in semiconductor detector fabrication?

Q9. What is a photocurrent?

Q10. Define responsivity

Pin Photodiodes

A **PIN photodiode** is a semiconductor positive-negative (p-n) structure with an intrinsic region sandwiched between the other two regions (see figure 7-2). It is normally operated by applying a reverse-bias voltage. The magnitude of the reverse-bias voltage depends on the photodiode application, but typically is less than a few volts. When no light is incident on the photodiode, a current is still produced. This current is called the **dark current**. The dark current is the leakage current that flows when a reverse bias is applied and no light is incident on the photodiode. Dark current is dependent on temperature. While dark current may initially be low, it will increase as the device temperature increases.

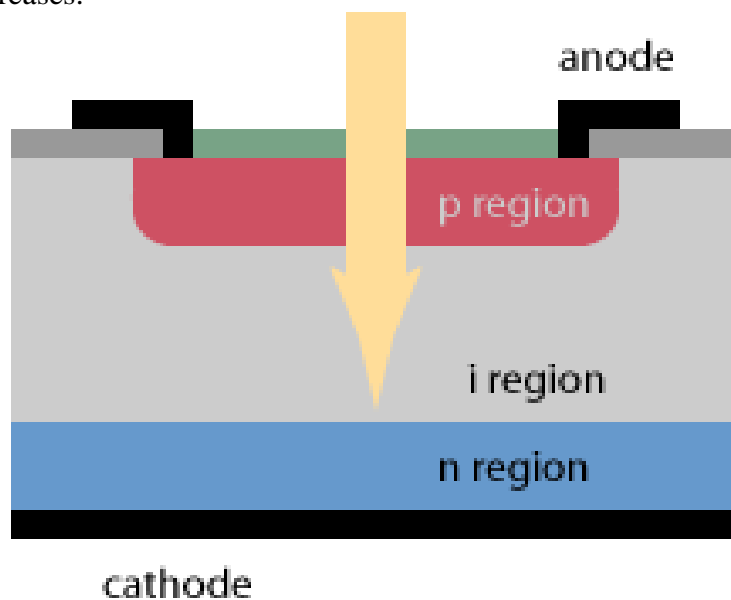

Figure 7-2. -The basic structure of a PIN photodiode

The result is that the addition of the "i" layer increases the responsivity and decreases the response time of the detector to around a few tens of picoseconds. The key to operation of a PIN diode is that the energy of the absorbed photon must be sufficient to promote an electron across the band gap - "i" layer (otherwise it won't be absorbed).

However, the material will absorb photons of any energy higher than its band gap energy. When discussing PIN diodes it is common to talk about the "cutoff wavelength". Typically PIN diodes will operate at any wavelength shorter than the cutoff wavelength. This suggests the idea of using a material with low band gap energy for all PIN diodes regardless of the wavelength.

Unfortunately, the lower the band gap energy the higher the "dark current" (thermal noise). Indeed but for this characteristic germanium would be the material of choice for all PIN diodes!

It is low in cost and has two useful band gaps (an indirect band gap at 0.67 eV and a direct band gap at 0.81 eV) However, it has a relatively high dark current compared to other materials.

This means that the materials used for PIN diode construction are different depending on the band of wavelengths for which it is to be used. However, this restriction is nowhere near as stringent as it is for lasers and LEDs where the characteristics of the material restrict the device to a very narrow range. The optimal way is to choose a material with a band gap energy slightly lower than the energy of the longest wavelength you want to detect.

An interesting consequence to note here is that these crystalline semiconductor materials are transparent at wavelengths longer than their cutoff. Thus, if we could "see" with 1500 nm eyes a crystal of pure silicon (which appears dark grey in visible light) would look like a piece of quartz or diamond.

Q11. How are PIN photodiodes usually biased?

Q12. What is the dark current?

Q13. Will dark current increase or decrease as the temperature of the photodiode increases?

Response Time

There are several factors that influence the response time of a photodiode and its output circuitry (see figure 7-3). The most important of these are the thickness of the detector active area and the detector RC time constant. The detector thickness is related to the amount of time required for the electrons generated to flow out of the detector active area. This time is referred to as the electron **transit time**. The thicker the detector active area, the longer the transit time will be.

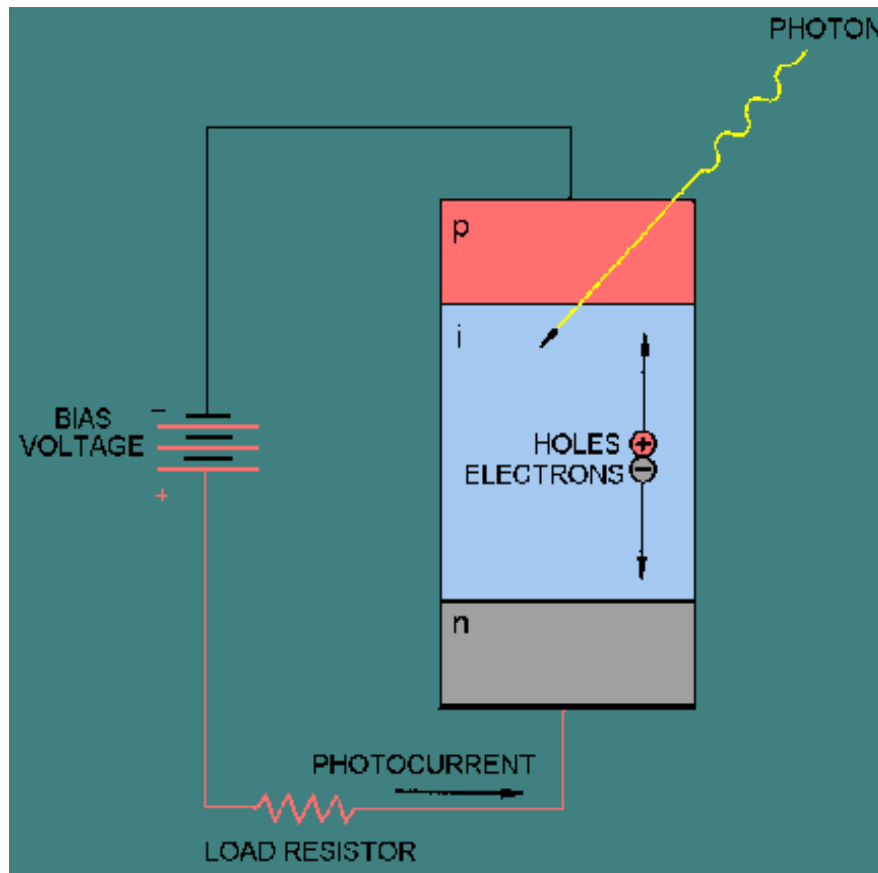

Figure 7-3. -A schematic representation of a photodiode

The **capacitance (C)** of the photodiode and the **resistance (R)** of the load form the RC time constant. The capacitance of the photodetector must be kept small to prevent the RC time constant from limiting the response time. The photodiode capacitance consists mainly of the junction capacitance and any capacitance relating to packaging. The **RC time constant** is given by $t_{RC} = RC$.

Trade-offs between fast transit times and low capacitance are necessary for high-speed response. However, any change in photodiode parameters to optimize the transit time and capacitance can also affect responsivity, dark current, and coupling efficiency. A fast transit time requires a thin detector active area, while low capacitance and high responsivity require a thick active region. The diameter of the detector active area can also be minimized. This reduces the detector dark current and minimizes junction capacitance. However, a minimum limit on this active area exists to provide for efficient fiber-to-detector coupling.

Q14. Should the capacitance of the photodetector be kept small or large to prevent the RC time constant from limiting the response time?

Q15. Trade-offs between competing effects are necessary for high speed response. Which competing effect (fast transit time, low capacitance, or high quantum efficiency) requires a thin active area?

Linearity

Reverse-biased photodetectors are highly linear devices. Detector **linearity** means that the output electrical current (photocurrent) of the photodiode is linearly proportional to the input optical power. Reverse-biased photodetectors remain linear over an extended range (6 decades or more) of photocurrent before saturation occurs. Output saturation occurs at input optical power levels typically greater than 1 milliwatt (mW). Because fiber optic communications systems operate at low optical power levels, detector saturation is generally not a problem.

Q16. Why is detector saturation not generally a problem in fiber optic communications systems?

Schottky-Barrier Photodiodes

In many circumstances the junction between a metal and a semiconductor can display some of the properties of a semiconductor p-n junction. Sometimes called "metal-semiconductor photodiodes", Schottky-Barrier photodiodes make use of this effect. Schottky photodiodes are not often used in current communications products but are the subject of much research as they promise much higher speed, more efficient, operation.

This is due to a number of characteristics:

- There are a number of semiconductors available which promise higher efficiency operations but cannot be used in regular p-n or p-i-n configurations because they can't be doped to both p and n characteristics.
- In addition with normal heterostructure devices you have to match the crystal lattice on both sides of the junction and this severely limits the choice of materials. When one side of the junction is metal you don't have either of these problems.
- The metal layer is a good conductor and so electrons are conducted away from the junction immediately. This means that recombination effects are minimized thus improving the efficiency. In addition it means faster operation.

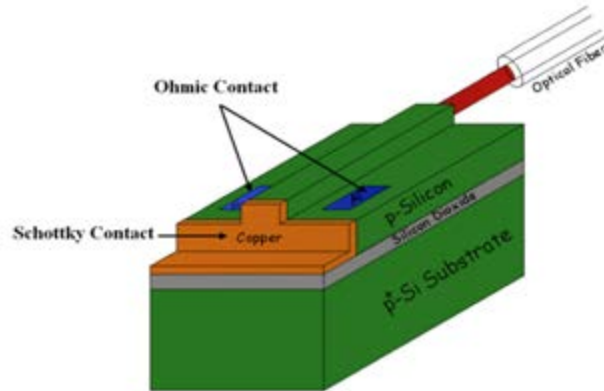

Figure 7-4. -A representation of a Schottky-Barrier photodiode

Q.17 What is the “promising advantage” of using a Schottky-Barrier photodiode?

AVALANCHE PHOTODIODES

An **avalanche photodiode (APD)** is a photodiode that internally amplifies the photocurrent by an avalanche process. Figure 7-4 shows an example APD structure. In APDs, a large reverse-bias voltage, typically over 100 volts, is applied across the active region. This voltage causes the electrons initially generated by the incident photons to accelerate as they move through the APD active region. As these electrons collide with other electrons in the semiconductor material, they cause a fraction of them to become part of the photocurrent. This process is known as **avalanche multiplication**. Avalanche multiplication continues to occur until the electrons move out of the active area of the APD.

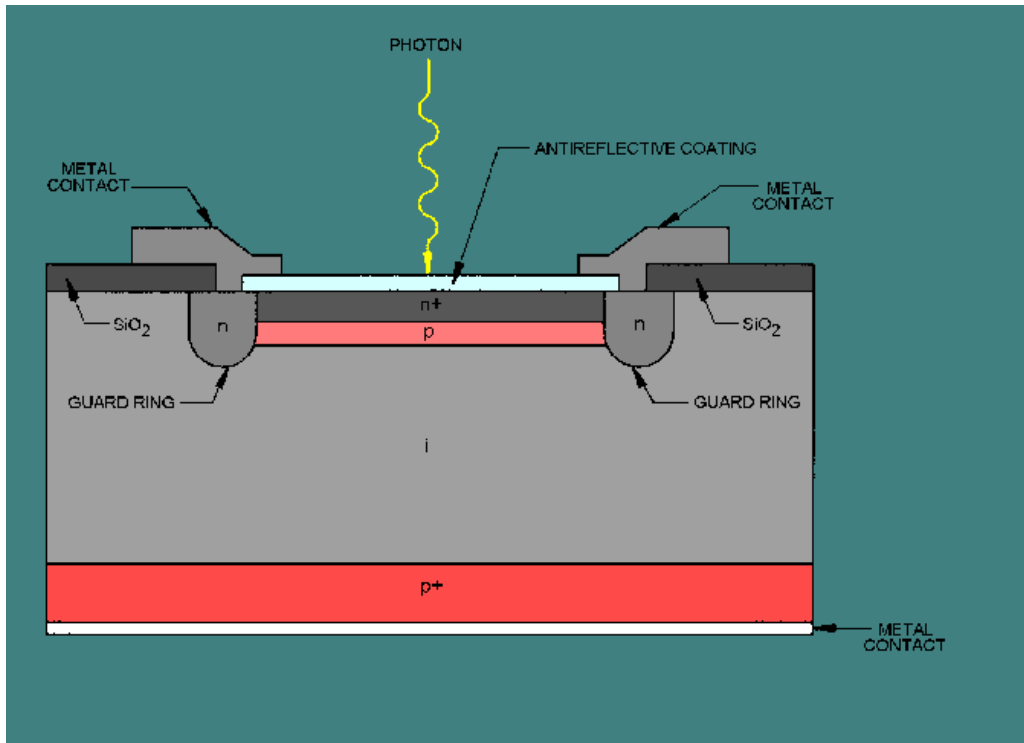

Figure 7-5. -The basic structure of an APD

The gain of the APD can be changed by changing the reverse-bias voltage. A larger reverse-bias voltage results in a larger gain. However, a larger reverse-bias voltage also results in increased noise levels. Excess noise resulting from the avalanche multiplication process places a limit on the useful gain of the APD. The avalanche process introduces excess noise because every photogenerated carrier does not undergo the same multiplication. The noise properties of an APD are affected by the materials that the APD is made of. Typical semiconductor materials used in the construction of low-noise APDs include silicon (Si), indium gallium arsenide (InGaAs), and germanium (Ge).

Trade-offs are made in APD design to optimize responsivity and gain, dark current, response time, and linearity. This chapter does not attempt to discuss trade-offs in APD design in more detail. Many aspects of the discussion provided on responsivity, dark current, and response time provided in the PIN photodiodes section also relate to APDs. The response time of an APD and its output circuitry depends on the same factors as PIN photodiodes. The only additional factor affecting the response time of an APD is the additional time required to complete the process of avalanche multiplication. To learn more about APD design trade-offs and performance parameters.

Q18. Describe avalanche multiplication.

Q19. How can the gain of an APD be increased?

FIBER OPTIC RECEIVERS

In fiber optic communications systems, optical signals that reach fiber optic receivers are generally attenuated and distorted (see figure 7-5). The fiber optic receiver must convert the input and amplify the resulting electrical signal without distorting it to a point that other circuitry cannot use it.

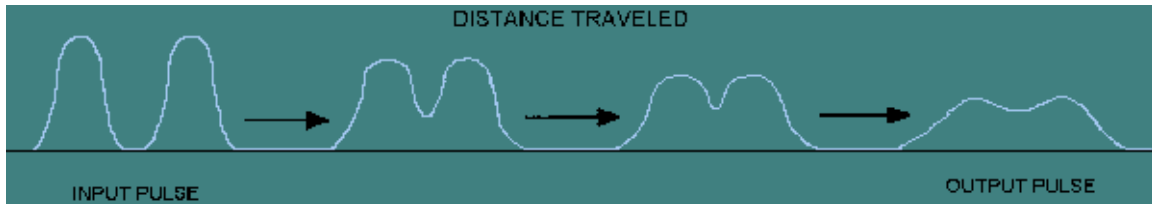

Figure 7-6. -Attenuated and distorted optical signals

As stated previously, a fiber optic receiver consists of an optical detector, an amplifier, and other circuitry. In most fiber optic systems, the optical detector is a PIN photodiode or APD. Receiver performance varies depending on the type of detector used. The amplifier is generally described as having two stages: the preamplifier and the postamplifier. The **preamplifier** is defined as the first stage of amplification following the optical detector. The **postamplifier** is defined as the remaining stages of amplification required to raise the detector's electrical signal to a level suitable for further signal processing. The preamplifier is the dominant contributor of electrical noise in the receiver. Because of this, its design has a significant influence in determining the sensitivity of the receiver.

The output circuitry processes the amplified signal into a form suitable for the interfacing circuitry. For digital receivers, this circuitry may include low-pass filters and comparators. For analog receivers, this circuitry may also include low-pass filters.

Receiver sensitivity, bandwidth, and dynamic range are key operational parameters used to define receiver performance. One goal in designing fiber optic receivers is to optimize receiver sensitivity. To increase sensitivity, receiver noise resulting from signal-dependent shot noise and thermal noise must be kept at a minimum. A more detailed discussion of receiver shot and thermal noise is provided later in this chapter.

In addition to optimizing sensitivity, optical receiver design goals also include optimizing the bandwidth and the dynamic range. A receiver that has the ability to operate over a wide range of optical power levels can operate efficiently in both short- and long-distance applications. Because conflicts arise when attempting to meet each goal, trade-offs in receiver designs are made to optimize overall performance.

Q20. Which amplifier stage (the preamplifier or the postamplifier) is a dominant contributor of noise and significantly influences the sensitivity of the receiver?

Q21. List the key operational parameters used to define receiver performance.

Receiver Noise

Noise corrupts the transmitted signal in a fiber optic system. This means that noise sets a lower limit on the amount of optical power required for proper receiver operation. There are many sources of noise in fiber optic systems. They include the following:

- Noise from the light source
- Noise from the interaction of light with the optical fiber
- Noise from the receiver itself

Because the intent of this chapter is to discuss optical detector and receiver properties, only noise associated with the photodetection process is discussed. **Receiver noise** includes thermal noise, dark current noise, and quantum noise. Noise is the main factor that limits receiver sensitivity.

Noise introduced by the receiver is either signal dependent or signal independent. Signal dependent noise results from the random generation of electrons by the incident optical power. Signal independent noise is independent of the incident optical power level.

Thermal noise is the noise resulting from the random motion of electrons in a conducting medium. Thermal noise arises from both the photodetector and the load resistor. Amplifier noise also contributes to thermal noise. A reduction in thermal noise is possible by increasing the value of the load resistor. However, increasing the value of the load resistor to reduce thermal noise reduces the receiver bandwidth. In APDs, the thermal noise is unaffected by the internal carrier multiplication.

Shot noise is noise caused by current fluctuations because of the discrete nature of charge carriers. Dark current and quantum noises are two types of noise that manifest themselves as shot noise. **Dark current noise** results from dark current that continues to flow in the photodiode when there is no incident light. Dark current noise is independent of the optical signal. In addition, the discrete nature of the photodetection process creates a signal dependent shot noise called quantum noise. **Quantum noise** results from the random generation of electrons by the incident optical radiation. In APDs, the random nature of the avalanche process introduces an additional shot noise called excess noise. For further information on the excess noise resulting from the avalanche process, refer to the avalanche photodiode section.

Q22. List the main types of receiver noise.

Q23. What is the main factor that determines receiver sensitivity?

Q24. For a reduction in thermal noise, should the value of the detector's load resistor be increased or decreased?

Q25. What are two types of noise that manifest themselves as shot noise?

Receiver Design

The simplest fiber optic receivers consist of only the optical detector and a load resistor. However, the output signal of these simple receivers is not in a suitable form for most types of interfacing circuitry. To produce a suitable signal, a preamplifier, a post amplifier, and other circuitry are generally included in the receiver.

The choice of an optical detector and the design of the preamplifier help determine the operational characteristics of the receiver. Fiber optic receivers using APDs have greater sensitivity than those using PIN photodiodes. In addition, trade-offs are made in preamplifier designs to increase sensitivity while optimizing bandwidth and dynamic range. The two basic types of amplifiers used in fiber optic receivers are the **high-impedance amplifier** and the **transimpedance amplifier**.

The high-impedance preamplifier is generally used with a large load resistor to improve sensitivity. The large load resistor is used to reduce thermal noise. Although the high-impedance preamplifier achieves high sensitivity, receiver bandwidth and dynamic range are limited. The transimpedance preamplifier uses a low-noise, high-input impedance amplifier with negative feedback. This design provides improvements in bandwidth and dynamic range with some degradation in sensitivity from an increase in noise.

Q26. What are the two basic types of preamplifiers used in fiber optic receivers?

Q27. Which preamplifier design (high-impedance or transimpedance) provides improvements in bandwidth and greater dynamic range with some degradation in sensitivity from an increase in noise?

Fiber Optic Receiver Packages

Fiber optic receivers come in packages similar to those for fiber optic transmitters. For information on fiber optic receiver packages, refer back to the fiber optic transmitter packages section of chapter 6.

Fiber Optic Receiver Applications

Fiber optic receivers can be classified into two categories: **digital** and **analog**. Digital receivers detect the input optical signal, amplify the digital photocurrent, and reshape the signal to produce an undistorted output electrical signal. Analog receivers detect the input optical signal and amplify the generated photocurrent.

Digital Applications

For most digital applications the designs of the digital fiber optic receivers are similar. For **low-data-rate** applications, PIN diodes and high impedance amplifiers are generally used. Receiver sensitivities are maximized by using large load resistors in the photodiode circuit. For **moderate-data-rate** applications, PIN diodes and either high impedance amplifiers with smaller load resistances or transimpedance amplifiers are used. For **high-data-rate** applications, PINs or APDs are used with transimpedance amplifiers. APDs are rarely used in low- or moderate-data-rate applications unless receivers with extremely low sensitivities are required.

For each digital application, the receiver will generally contain a low-pass filter. The pass-band of the filter depends on the data rate of the application. The filter is used to smooth the amplified signal to remove some of the high frequency noise before the signal is further processed. The digital receiver generally contains a comparator, which reshapes the amplified electrical signal to remove any distortions introduced in the transmission process. In some cases the receiver may also contain clock recovery circuitry, which retimes the output electrical signal as well.

Q28. For what types of applications are APDs generally used?

Q29. Why is a low-pass filter generally part of a digital fiber optic receiver?

Analog Applications

Analog receivers are similar in design to digital receivers with the exception that digital signal restoring circuitry is not used. The preamplifier and postamplifiers are designed to be more linear than those used in digital receivers in some cases.

For **low-frequency** applications, PIN diodes and high impedance amplifiers are generally used. For **moderate-frequency** applications, PIN diodes and either high impedance amplifiers or transimpedance amplifiers are used. For **high-frequency** applications, PINs or APDs are used with transimpedance amplifiers. As in digital applications, APDs are rarely used in low- or moderate-frequency applications unless receivers with extremely low sensitivities are required.

SUMMARY

Now that you have completed this chapter, let's review some of the new terms, concepts, and ideas that you have learned. You should have a thorough understanding of these principles before moving on to chapter 8.

A **FIBER OPTIC RECEIVER** is an electro-optic device that accepts optical signals from an optical fiber and converts them into electrical signals. A typical fiber optic receiver consists of an optical detector, a low-noise amplifier, and other circuitry used to produce the output electrical signal.

RECEIVER SPECTRAL RESPONSE, SENSITIVITY, FREQUENCY RESPONSE, and **DYNAMIC RANGE** are key receiver performance parameters that can affect overall system operation.

RECEIVER SENSITIVITY is the minimum amount of optical power required to achieve a specific receiver performance. For digital transmission at a given data rate and coding, this performance is described by a maximum bit-error rate (BER). In analog systems, for a given modulation and bandwidth, it is described by a minimum signal-to-noise ratio (SNR).

DYNAMIC RANGE refers to the range of optical power levels over which the receiver operates within the specified values. It usually is described by the ratio of the maximum input power to the sensitivity.

A **TRANSDUCER** is a device that converts input energy of one form into output energy of another.

An **OPTICAL DETECTOR** is a transducer that converts an optical signal into an electrical signal. It does this by generating an electrical current proportional to the intensity of incident optical radiation.

The semiconductor **POSITIVE-INTRINSIC-NEGATIVE (PIN) PHOTODIODE** and **AVALANCHE PHOTODIODE (APD)** are the principal optical detectors used in fiber optic systems.

A **PHOTOCURRENT** is generated when photons are absorbed by a photodiode.

RESPONSIVITY is the ratio of the optical detector's output photocurrent in amperes to the incident optical power in watts.

DARK CURRENT, or reverse-leakage current, is the current that continues to flow in the photodetector when there is no incident light.

The **RESPONSE TIME** of a photodiode and its output circuitry depends primarily on the thickness of the detector active area and the detector RC time constant.

The **TRANSIT TIME** is the time it takes electrons to travel out of the detector active area.

The **RC TIME CONSTANT** is defined by the capacitance (C) of the photodiode and the resistance (R) of the load. The RC time constant is given by $t_{RC} = RC$.

A **HIGH-SPEED RESPONSE** requires short transit times and low capacitance. However, any change in photodiode parameters to optimize the transit time and capacitance can also affect quantum efficiency, dark current, and coupling efficiency.

Detector **LINEARITY** means that the output electrical current (photocurrent) of the photodiode is linearly proportional to the input optical power.

An **AVALANCHE PHOTODIODE (APD)** is a photodiode that internally amplifies the photocurrent by an avalanche process.

In **APDs**, a large **REVERSE-BIAS VOLTAGE**, typically over 100 volts, is applied across the active region.

AVALANCHE MULTIPLICATION occurs when accelerated electrons collide with other electrons in the semiconductor material, causing a fraction of them to become part of the photocurrent.

TRADE-OFFS are made in APD design to optimize responsivity and gain, dark current, response time, and linearity.

The **RESPONSE TIME** of APDs accounts for the avalanche build-up time in addition to transit time and RC time constant.

The **PREAMPLIFIER** is defined as the first stage of amplification following the optical detector.

The **POSTAMPLIFIER** is defined as the remaining stages of amplification required to raise the detectors electrical signal to a level suitable for further signal processing.

RECEIVER SENSITIVITY, BANDWIDTH, and DYNAMIC RANGE are key operational parameters used to define receiver performance.

NOISE is the main factor that determines receiver sensitivity.

RECEIVER NOISE includes thermal noise, dark current noise, and quantum noise.

THERMAL NOISE is the noise resulting from the random motion of electrons in a conducting medium.

SHOT NOISE is noise caused by current fluctuations due to the discrete nature of charge carriers.

DARK CURRENT NOISE results from dark current that continues to flow in the photodiode when there is no incident light.

QUANTUM NOISE results from the random generation of electrons by the incident optical radiation.

The **HIGH-IMPEDANCE AMPLIFIER** and the **TRANSIMPEDANCE AMPLIFIER** are the two basic types of amplifiers used in fiber optic receivers.

The **HIGH-IMPEDANCE PREAMPLIFIER** provides a high sensitivity, but limits receiver bandwidth and dynamic range.

The **TRANSIMPEDANCE PREAMPLIFIER** provides improvements in bandwidth and dynamic range with some degradation in sensitivity from an increase in noise.

PIN PHOTODIODES are used as the detector in most applications.

SCHOTTKY BARRIER PHOTODIODE sometimes called "metal-semiconductor photodiodes", a transition region formed within a semiconductor surface to serve as a rectifying barrier at a junction with a layer of metal.

AVALANCHE PHOTODIODES are only used in high-speed applications and applications where detectors with extremely low sensitivities are required.

ANSWERS TO QUESTIONS Q1. THROUGH Q28.

- A1. *An electro-optic device that accepts optical signals from an optical fiber and converts them into electrical signals.*
- A2. *Amplifier.*
- A3. *Receiver sensitivity.*
- A4. *The range of optical power levels over which the receiver operates within the specified values. It usually is described by the ratio of the maximum input power to the sensitivity.*
- A5. *It is a transducer that converts an optical signal into an electrical signal. It does this by generating an electrical current proportional to the intensity of incident optical radiation.*
- A6. *High.*
- A7. *The semiconductor positive-intrinsic-negative (PIN) photodiode and avalanche photodiode (APD).*
- A8. *Silicon, gallium arsenide, germanium, and indium phosphide.*
- A9. *The current produced when photons are incident on the detector active area.*
- A10. *The ratio of the optical detector's output photocurrent in amperes to the incident optical power in watts.*
- A11. *Reverse-biased.*
- A12. *The leakage current that continues to flow through a photodetector when there is no incident light.*
- A13. *Increase.*
- A14. *Small.*
- A15. *Fast transit time.*
- A16. *Because fiber optic communications systems operate at low optical power levels.*

A17. Schottky photodiodes "metal-semiconductor photodiodes" are not often used in current communications products but are the subject of much research as they promise much higher speed, more efficient, operation. The metal layer is a good conductor and so electrons are conducted away from the junction immediately. This means that recombination effects are minimized thus improving the efficiency. In addition it means faster operation.

A18. The electrons initially generated by the incident photons accelerate as they move through the APD active region. As these electrons collide with electrons in the semiconductor material, they cause a fraction of them to become part of the photocurrent.

A19. By increasing the reverse-bias voltage.

A20. The preamplifier.

A21. Receiver sensitivity, bandwidth, and dynamic range.

A22. Thermal noise, dark current noise, and quantum noise.

A23. Noise.

A24. Increased.

A25. Dark current and quantum noises.

A26. The high-impedance amplifier and the transimpedance amplifier.

A27. Transimpedance.

A28. For high-data-rate applications and for low- or moderate-data-rate applications where receivers with extremely low sensitivities are required.

A29. To smooth the amplified signal to remove some of the high frequency noise before the signal is further processed.

CHAPTER 8

FIBER OPTIC LINKS

LEARNING OBJECTIVES

Upon completion of this topic, you should be able to do the following:

1. Describe a basic point-to-point fiber optic data link.
2. Explain the difference between Bus, Ring, Star and tree topologies.
3. Discuss system protocols such as FDDI, Ethernet, and Fibre Channel.
4. Describe the main type of analog modulation.
5. Describe wave-length division multiplexing.
6. Understand Passive Optical Networks and the role it plays in Fiber-to-the-Home.
7. State several precautions that need to be emphasized when installing fiber optic links on board ships.

FIBER OPTIC SYSTEM TOPOLOGY

Most of the discussion on fiber optic data links provided earlier in this training manual refers to simple point-to-point links. A **point-to-point** fiber optic data link consists of an optical transmitter, optical fiber, and an optical receiver. In addition, any splices or connectors used to join individual optical fiber sections to each other and to the transmitter and the receiver are included. Figure 8-1 provides a schematic diagram of a point-to-point fiber optic data link.

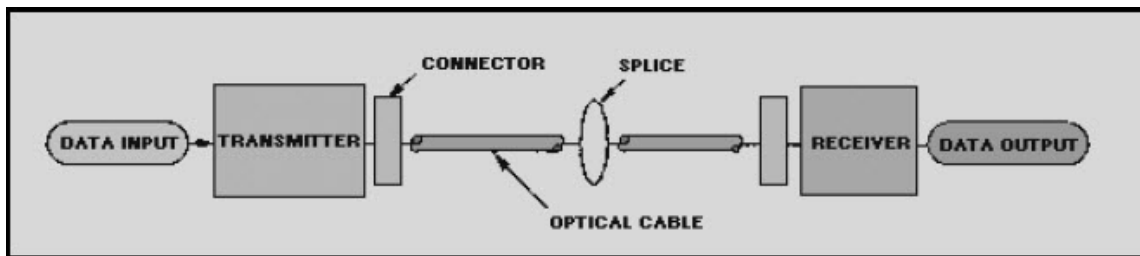

Figure 8-1. -A schematic diagram of a point-to-point fiber optic data link

A common fiber optic application is the **full duplex link**. This link consists of two simple point-to-point links. The links transmit in opposite directions between the equipment's. This application may be configured using only one fiber. If configured with

one fiber, fiber optic splitters are used at each end to couple the transmit signal onto the fiber and receive signal to the detector.

All fiber optic systems are simply sets of point-to-point fiber optic links. Different system topologies arise from the different ways that point-to-point fiber optic links can be connected between equipment's. The term **topology**, as used here, refers to the configuration of various equipment's and the fiber optic components interconnecting them. This equipment may be computers, workstations, consoles, or other equipment's. Point-to-point links are connected to produce systems with linear bus, ring, star, or mesh topologies. Point-to-point fiber optic links are the basic building block of all fiber optic systems.

A logical topology defines the direction and logical pathways that communications data (voice, data or video information) travels in order for the network to operate. Logical topologies differ substantially within data networks and especially between voice and video networks.

A **linear bus topology** consists of a single transmission line that is shared by a number of equipment's shown in figure 8-2. Generally the transmission line in a fiber optic linear bus consists of two optical lines, one for each direction of communication. Optical taps (optical splitters) are used by each equipment to connect to each line. For each line, the optical tap couples signals from the line to the equipment receiver and from the equipment transmitter onto the line. The connection between any two equipment's is a simple point-to-point link that contains the optical tap for each equipment.

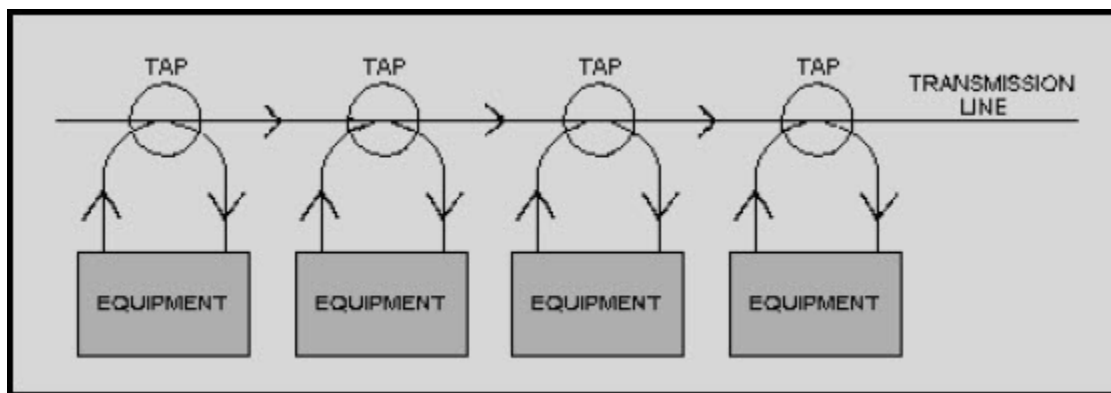

Figure 8-2. -Linear bus topology

A **ring topology** consists of equipment's attached to one another in a closed loop or ring shown in figure 8-3. The connection between each equipment is a simple point-to-point link. In some systems each equipment may have an associated optical switch. In normal operation, the switch routes signals from the fiber connected to the previous equipment to the receiver. It also routes signals from the transmitter to the fiber connected to the next equipment. In bypass operation, the switch routes signals from the fiber connected to the previous equipment to the fiber connected to the next equipment. In each case, the connection between adjacent equipment on the ring is a simple point-to-

point link through fiber, connectors, and switches. The signal moves in a single direction around the ring until it reaches the addressed station. Examples are Token Ring (IEEE 802.5), FDDI (ANSI X3T9.5), SONET, ATM and Fibre Channel (arbitrated loop). Each station in a logical ring strips off the data, looks at the address and passes it on if the message is not for one of its stations.

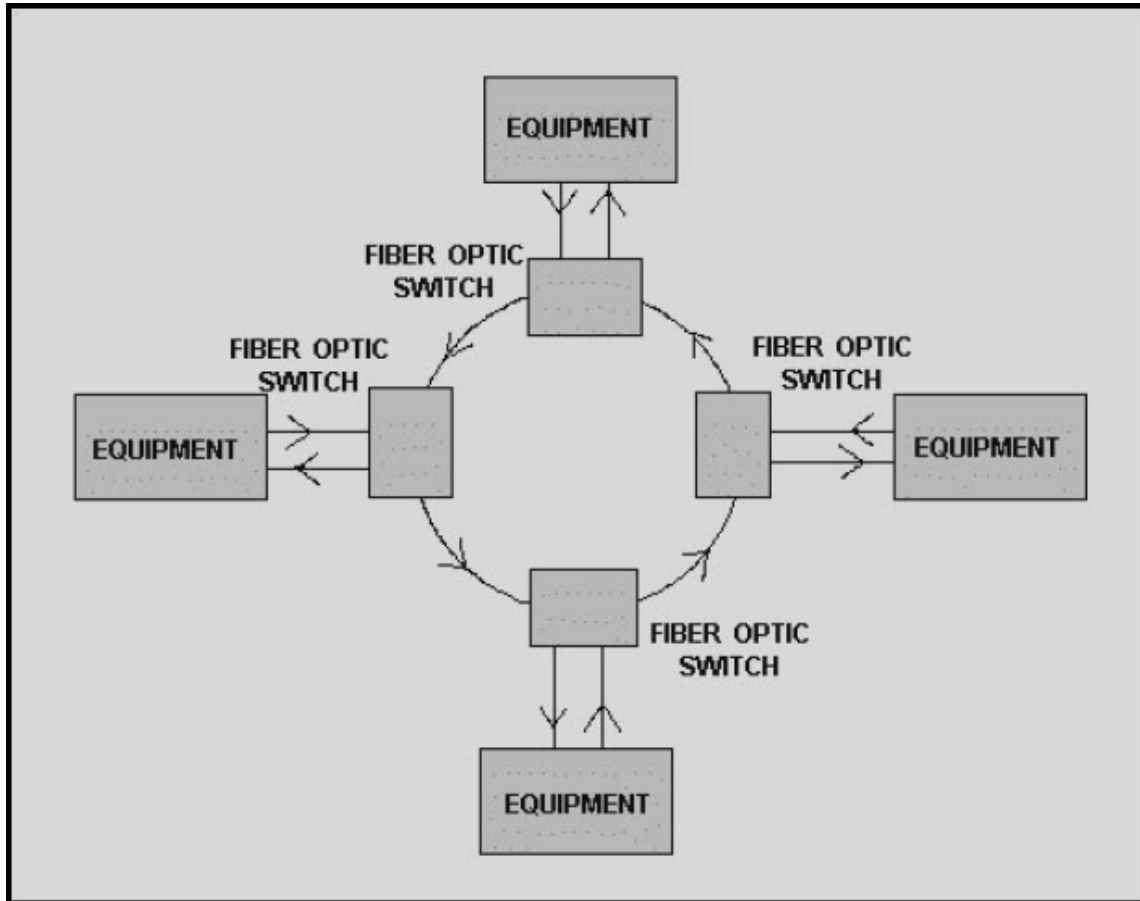

Figure 8-3. -Ring topology

In the **star topology**, each equipment is connected to a common center hub as shown in figure 8-4. The center hub can be a passive fiber optic star coupler or an active equipment. If the center hub is a passive star coupler, each equipment transmitter is connected to an input port of the coupler and an output port of the coupler is connected to each equipment receiver. The connection between any two equipment's is a simple point-to-point link through the star coupler. If the center hub is an active equipment, the connection between any two equipment's consists of two point-to-point links. Each connection consists of one link from the first equipment to the center hub and a second link from the center hub to the second equipment. Examples of logical star topologies are ATM, Voice, Video, Switched Ethernet, Gigabit Ethernet and Fibre Channel (fabric).

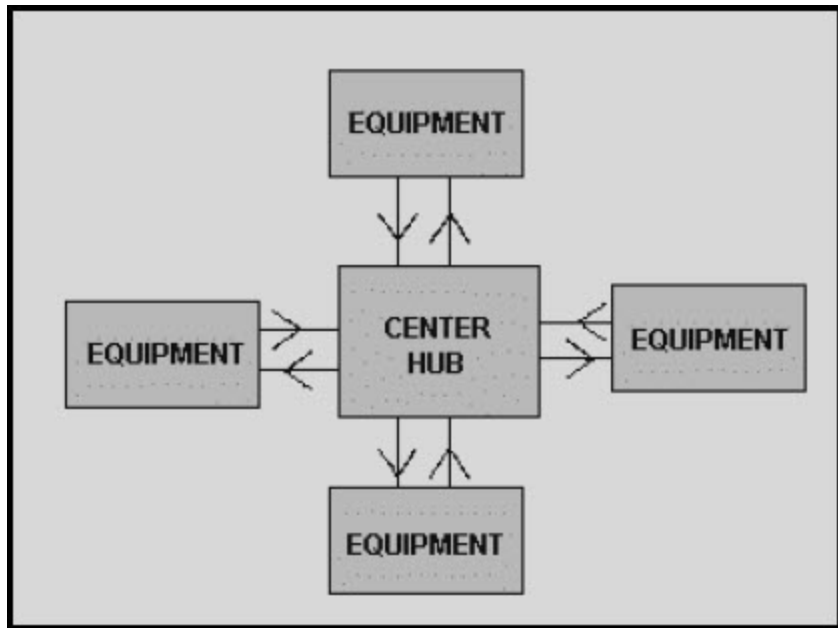

Figure 8-4. -Star topology

A **tree topology** consists of a transmission line that branches, or splits as shown in figure 8-5. A tree topology may have many different branching points. At each branching point either a passive fiber optic splitter or an active branching device is used. In many cases both passive couplers and active branching devices are used within a particular system. Regardless of the branching method, each connection within the tree is a simple point-to-point link through splitters or multiple point-to-point links through active branching devices.

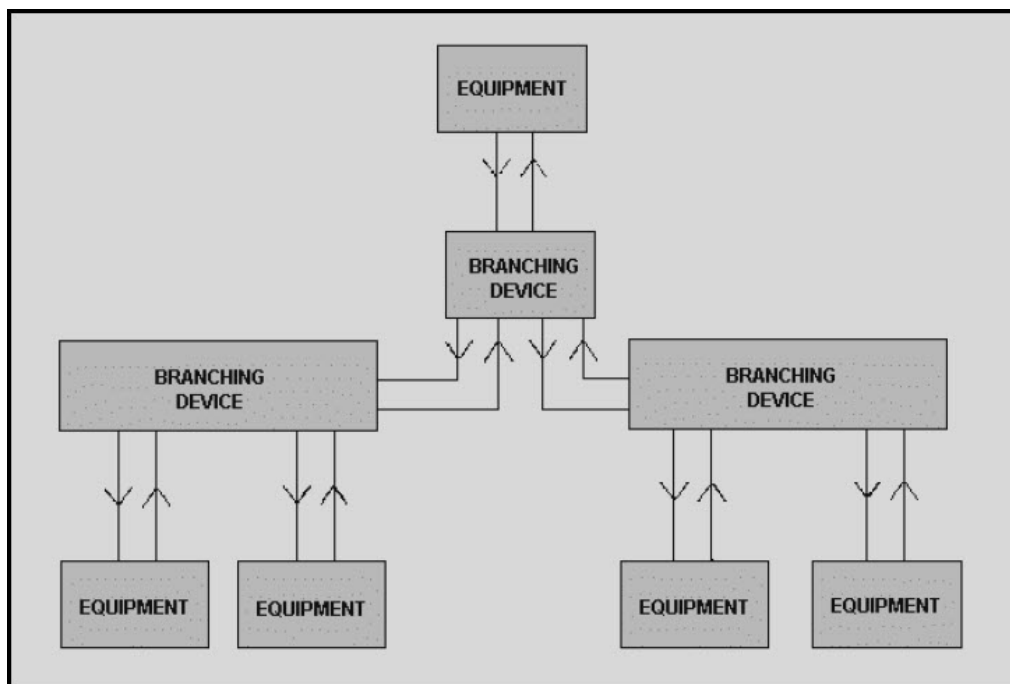

Figure 8-5. -Tree topology

Q1. List four system topologies that can be constructed using point-to-point fiber optic links.

Q2. Which topology (linear bus, ring, star, or tree) consists of equipment's attached to one another in a closed loop?

Q3. Which topology (bus, ring, star, or tree) has a center hub interconnecting the equipment's?

FIBER OPTIC NETWORKS

Networks are making increasing use of fiber optics as their data rates and transmission distances expand. Small local-area networks are increasingly using fibers, but high-speed wide-area networks are all going to fiber to link smaller LANs or devices requiring high-speed connection. Many network architectures have been developed and tested, but only a few have gained wide acceptance. These common networks have standardized designs and interfaces, so they can connect various devices in a uniform way. This gives user's vital flexibility in connecting different equipment as well as helping them predict behavior of hardware and software.

The first generation of local-area networks used standards such as standard Ethernet and the IBM Token Ring network, transmitting 10 Mbit/s. That seemed adequate a decade ago, and many such networks are still operating. However, transmission rates have pushed steadily upward for local-area networks and are even higher for wide-area networks. Interconnecting LANs exist using a 100-Mbit/s Fast Ethernet followed the original 10-Mbit/s Ethernet, with Gigabit Ethernet emerging in 1998. Today 10, 40, 100, and 400 Gigabit Ethernet are common. Fibers are important elements of the faster Ethernets, as well as of networked versions of Fibre Channel and of the 100-Mbit/s Fiber Distributed Data Interface (FDDI) standard.

10-Mbit/s Ethernet

The first LAN to gain much acceptance was the original Ethernet standard codified as IEEE (Institute of Electrical and Electronics Engineers) standard 802.3. It distributes digital data packets of variable length at 10 Mbit/s to transceivers dispersed along a coaxial or fiber optic cable bus, as shown in Figure 8-6. The network can serve up to 1024 terminals.

An Ethernet network has no overall controller; control functions are handled by individual transceivers. If a terminal is ready to send a signal, its transceiver checks if another signal is going along the fiber cable. Transmission is delayed if another signal is present. If not, the terminal begins transmitting and continues until it finishes or detects a

collision - the transmission of data at the same time by a second terminal. Such collisions happen because it takes time - several nanoseconds a meter - for signals to travel along a coaxial cable. If the delay is 6 ns/m, a collision would occur if two terminals 300 meters apart on the cable started sending within 1.8 μ s of each other. The terminal stops transmitting if it detects a collision and waits a random interval before trying again.

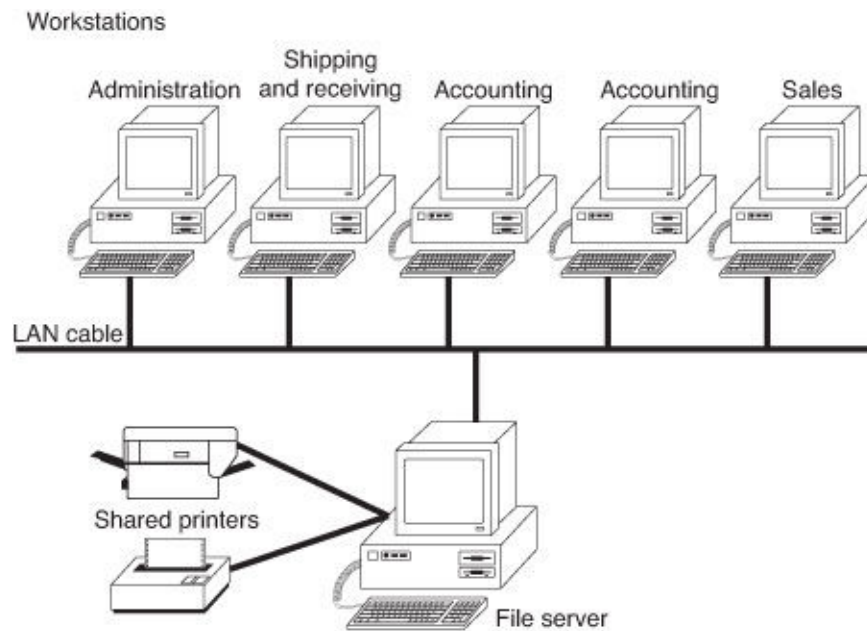

Figure 8-6. – Fiber optic bus network

An address header specifies the destination for every data signal. All the transceivers on the network see every data signal, but they ignore the signals not directed to them. The only signals the transceiver relays to the terminal attached to it are those with the terminal's address.

There are some important variations on the basic 1—Mbit/s Ethernet design. The original standard heavy coaxial cable allows transceivers to be up to 500 meters apart, but it is expensive. Substituting a lighter grade of coax limits transceiver spacing to 200 meters, but this “thin” Ethernet is adequate for most purposes. Another alternative is using twisted-wire pairs, which can carry signals up to about 100 meters. In addition to the data bus configuration shown in figure 8-6, Ethernet often is arranged in a star configuration such as in figure 8-7, with cables radiating outward from a hub, which relays signals to other terminals.

Optical fibers can stretch transmission distances beyond the limit imposed by the loss of coaxial cable top distances limited by other factors, such as the time signals take to travel through the network. Often, a point-to-point fiber link may connect two coaxial segments of an Ethernet or a remote terminal with a central Ethernet. This allows a single

Ethernet to link terminals in different buildings, which is difficult with the 500 meter limit of coax.

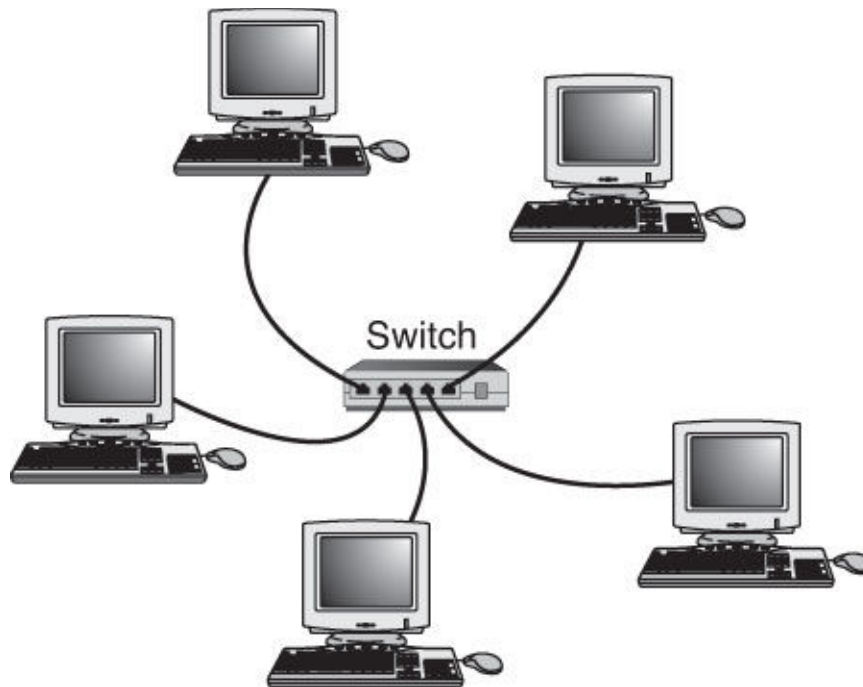

Figure 8-7. - Star configuration

The maximum transmission distance depends on whether the network is operating in half-duplex mode, so terminals either transmit or receive at any one time, or in full-duplex mode, where they simultaneously send and receive data. In half-duplex mode, the maximum distance is 2 km for either multimode or single mode fiber. In full-duplex mode, multimode fiber allows cable runs to 2.5 km, and single mode allows spacing to 15 km.

Fast Ethernet (100 Mbit/s)

As the name implies, fast Ethernet is a faster version of Ethernet, using interface cards that operate at 100-Mbit/s but retain the same frame format and transmission protocols as the original 10-Mbit/s Ethernet. The fast Ethernet standard was approved in 1995. It uses the same network configurations and cabling as 10-Mbit/s Ethernet; the major change is replacing 10-Mbit/s Ethernet cards with fast Ethernet cards. However, the faster speed limits coax runs to 100 meters.

The fast Ethernet specification limits half-duplex transmission to 412 meters over either single mode or multimode fiber, a travel time of 2 μ s. Full-duplex transmission stretches the maximum distance to 2 km for multimode fiber and 10 km for single mode. The differences arise because of differences in the nature of half- and full-duplex transmission.

Gigabit Ethernet (1 Gbit/s)

Gigabit Ethernet is being installed on a regular basis and for those applications that require increasing transmission speeds is 10-Gigabit Ethernet. Single mode fiber can transmit Gigabit Ethernet up to 5 km. The high transmission speed and low equipment costs have led to much interest in Gigabit Ethernet for fiber-to-the-home neighborhood systems.

Fiber Distributed Data Interface (FDDI)

The Fiber Distributed Data Interface (FDDI) is a network standard covering transmission at 100 Mbit/s. It can serve up to 500 nodes on a dual-ring network with up to 2 km between nodes. Originally developed for graded-index multimode fiber, the standard has been expanded to cover single mode fibers and copper wires. The FDDI standard calls for the ring topology shown in figure 8-8, with two rings that can transmit signals in opposite directions to a series of nodes. It also specifies concentrator-type terminals that allow stars and/or branching trees to be added to the main FDDI back-bone ring. Normally one ring carries signals while the other is kept in reserve in case of component or cable failure. The maximum distance between nodes is 2 km over multimode fiber at 1300 nm.

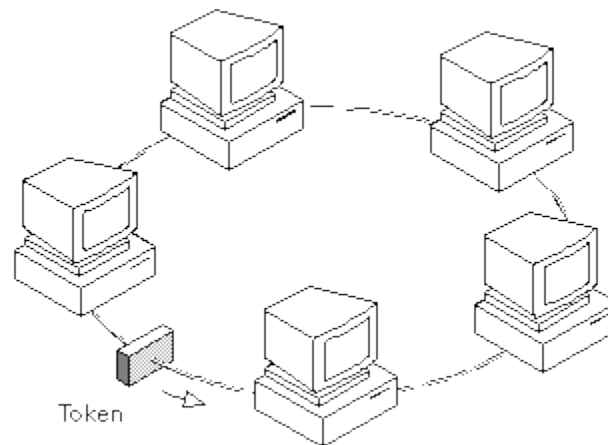

Figure 8-8. – Token Ring topology

FDDI transmission is controlled by a scheme of “token passing” used in slower-speed token ring networks, covered by the IEEE.802.5 standard. Terminals do not contend for space to send signals, as does Ethernet, but instead pass around the loop an authorization code called a *token*. When a node with a message to send receives the token, it holds the token and sends the message, which includes a code identifying its destination. All other nodes ignore the message, which is canceled when it completes its path around the ring. Then the terminal that sent the message begins passing the token around the ring again.

FDDI uses a 4 of 5 transmission code that adds one extra bit for every four data bits, so the line rate is 125 Mbit/s. The standard was developed around fiber-optic transmission, but copper wires can be used over short distances.

Fibre Channel

The Fibre Channel standard covers a range of signal transmission. In addition to its use as a storage-area network and point-to-point transmission standard for computer systems, it can be used for back-bone networks and switched transmission. Hubs connect nodes to form loops; switches are interconnected to make a fabric that functions somewhat like the phone system in directing signals between devices.

Fibre Channel uses a 10-bit coding for each 8-bit byte. The bits can enter the system in parallel, but Fibre Channel transmits them in series. Data rates can be specified either as megabits per second (Mbit/s, sometimes abbreviated Mb/s) or megabytes (Mbytes, sometimes abbreviated MB).

Like Gigabit Ethernet, Fibre Channel allows transmission over copper as well as fiber. Twisted pair, coax, and twin ax are the major alternatives for speeds of 1 Gbit/s and below; at higher rates only fiber is specified. Transmission can be in the short or long wavelength bands. Like Ethernet, the Fibre Channel protocol limits the numbers of terminals in a loop and the arrangement of hubs and switches.

Q4. What IEEE standard governs standard Ethernet?

Q5. What is the maximum distance of half-duplex transmissions?

Q6. FDDI transmissions are controlled by what coding scheme?

LINK CLASSIFICATION

While there are several ways to classify fiber optic links, this chapter classifies links according to the modulation type: either digital or analog. **Modulation** is the process of varying one or more characteristics of an optical signal to encode and convey information. Generally, the intensity of the optical signal is modulated in fiber optic communications systems. Digital modulation implies that the optical signal consists of discrete levels. Analog modulation implies that the intensity of the optical signal is proportional to a continuously varying electrical input. Most fiber optic systems are digital because digital transmission systems generally provide superior performance over analog transmission systems.

Q7. Define modulation.

Digital Transmission

A **digital signal** is a discontinuous signal that changes from one state to another in discrete steps. A popular form of digital modulation is **binary**, or two level, digital modulation. In binary modulation the optical signal is switched from a low-power level (usually off) to a high-power level. There are a number of modulation techniques used in digital systems, but these will not be discussed here.

Line coding is the process of arranging symbols that represent binary data in a particular pattern for transmission. The most common types of line coding used in fiber optic communications include no return- to-zero (NRZ), return-to-zero (RZ), and biphase, or Manchester. Figure 8-9 illustrates NRZ, RZ, and biphase (Manchester) encoding.

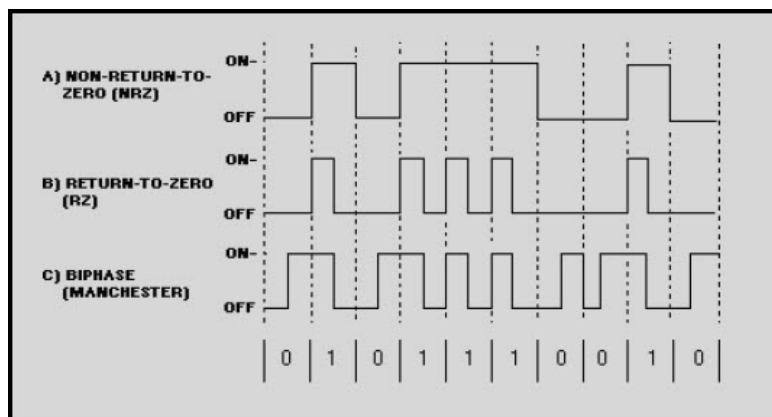

Figure 8-9. - NRZ, RZ, and biphase (Manchester) encoding

NRZ code represents binary 1s and 0s by two different light levels that are constant during a bit duration. The presence of a high-light level in the bit duration represents a binary 1, while a low-light level represents a binary 0. NRZ codes make the most efficient use of system bandwidth. However, loss of timing may result if long strings of 1s and 0s are present causing a lack of level transitions.

RZ coding uses only half the bit duration for data transmission. In RZ encoding, a half period optical pulse present in the first half of the bit duration represents a binary 1. While an optical pulse is present in the first half of the bit duration, the light level returns to zero during the second half. A binary 0 is represented by the absence of an optical pulse during the entire bit duration. Because RZ coding uses only half the bit duration for data transmission, it requires twice the bandwidth of NRZ coding. Loss of timing can occur if long strings of 0s are present.

Biphase, or Manchester, encoding incorporates a transition into each bit period to maintain timing information. In Manchester encoding, a high-to-low light level transition occurring in the middle of the bit duration represents a binary 1. A low-to-high light level transition occurring in the middle of the bit duration represents a binary 0.

Digital transmission offers an advantage with regard to the acceptable signal-to-noise ratio (SNR) at the optical receiver. Digital communications systems can tolerate large amounts of signal loss and dispersion without impairing the ability of the receiver to distinguish a binary 1 from a binary 0. Digital signaling also reduces the effects that optical source nonlinearities and temperature have on system performance. Source nonlinearities and temperature variations can severely affect analog transmission. Digital transmission provides superior performance in most complex systems (such as LANs) and long haul communications systems. In short-haul systems, the cost and complexity of analog-to-digital and digital-to-analog conversion equipment, in some cases, outweigh the benefits of digital transmission.

Q8. What is a digital signal?

Q9. In NRZ code, does the presence of a high-light level in the bit duration represent a binary 1 or a binary 0?

Q10. How can the loss of timing occur in NRZ line coding?

Q11. How is a binary 1 encoded in RZ line coding?

Q12. In Manchester encoding, does a low-to-high light level transition occurring in the middle of the bit duration represent a binary 1 or a binary 0?

Analog Transmission

An **analog signal** is a continuous signal whose amplitude, phase, or some other property varies in a direct proportion to the instantaneous value of a physical variable. An example of an analog signal is the output power of an optical source whose intensity is a function of a continuous electrical input signal.

Most analog fiber optic communications systems intensity modulate the optical source. In **intensity modulation**, the intensity of the optical source's output signal is directly modulated by the incoming electrical analog baseband signal. A **baseband signal** is a signal that is in its original form and has not been changed by a modulation technique.

In some cases, the optical source may be directly modulated by an incoming electrical signal that is not a baseband signal. In these cases the original electrical signal

generally modulates an electrical subcarrier frequency. The most common form of analog subcarrier modulation in fiber optic systems is frequency modulation (FM). The optical source is intensity modulated by the electrical subcarrier.

While most fiber optic systems employ digital modulation techniques, there are certain applications where analog modulation techniques are preferred. The transmission of video using analog techniques is very popular, especially for shorter distances, where costs can be minimized and complex multiplexing and timing equipment is unnecessary. The transmission of analog voice signals may also be attractive in small, short-haul systems. In addition, fiber optic sensor systems may incorporate analog transmission. Requirements that analog transmission places on applications include high signal-to-noise ratio and high source linearity. While analog transmission can be attractive for short-haul or medium-haul systems, it is unattractive for long-haul systems where digital techniques provide better performance.

Q13. What is an analog signal?

Q14. What type of modulation do most analog fiber optic communications systems use?

Q15. Why has the transmission of video using analog techniques been very popular, especially for shorter distances?

MULTIPLEXING

Wavelength Division Multiplexing (WDM)

WDM is a Frequency Division Multiplexing (FDM) technique for fiber-optic cable in which multiple optical signal channels are carried across a single strand of fiber at different wavelengths of light. These channels are also called *lambda circuits*. Think of each wavelength as a different color of light in the infrared range that can carry data. A fiber-optic cable guides light from end to end. A signal is injected in one end by a semiconductor laser. Lasers for silica-based fiber-optic cables produce light in a range called a "window." These windows occupy the near infrared range at wavelengths of 850 nm (nanometer or billionths of a meter), 1310 nm, 1490 nm, 1550 nm, and 1620 nm. For example, you may see a system described as a 1550 nm system. Optical multiplexers divide the window into many individual lambdas. Each lambda circuit is capable of transmitting 2.5 Gbps for a total of 40 Gbps. See figure 8-10 (16 channels X 2.5Gbps = 40Gbps).

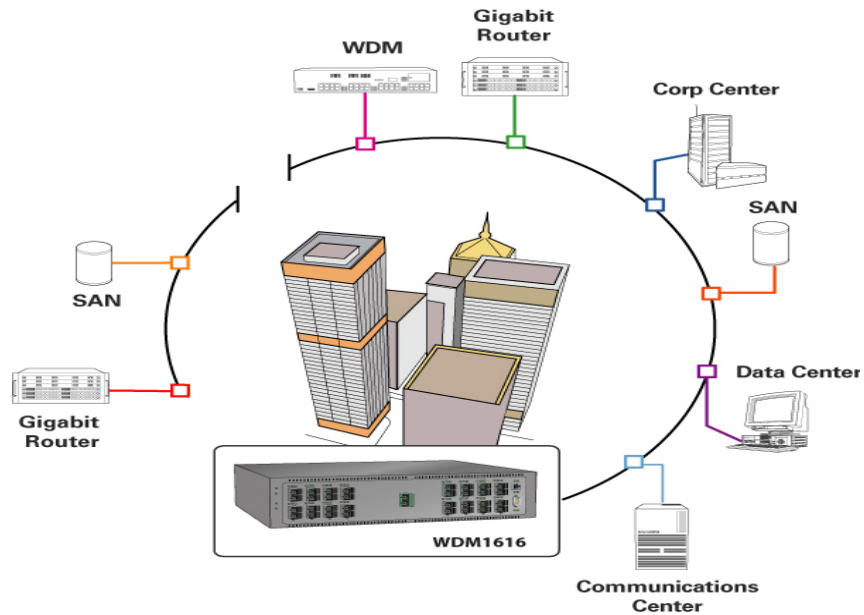

Figure 8-10 - 16-Channel, 16-Wavelength WDM Systems

It is important to note that in WDM, the wavelengths of the optical channels must be close in spectrum of each other in order to work within the bandwidth limits of the transmission system. Conversely, the wavelengths must be far enough apart from each other to ensure separate detection without interference. As an example of a WDM multiplexing scenario, a WDM system could have 18 optical channels or lambda circuits operating on one fiber. The 1550 nm band silica fiber cable offers 100nm of optical bandwidth, where each optical channel uses a laser operating at wavelengths spaced 2 nm apart (therefore, good performance can be expected using 50 channels Wave Division Multiplexed onto one fiber in the 1500 nm band).

The 2 nm spacing arrangement depends on the temperature and frequency stability capability of the laser light source. Therefore, if 18 channels are Wave Division Multiplexed using lasers having 1 Celsius temperature and high frequency stability, the system can have a capacity of 2.3 million voice channels on one pair of optical fibers.

NOTE: 18 x is the capacity of OC-192 or 18 x 129,024 voice channels = 2,322,432 voice channels, see figure 8-11.

The term *wavelength-division multiplexing* is commonly applied to an optical carrier (which is typically described by its wavelength), whereas frequency-division multiplexing typically applies to a radio carrier (which is more often described by frequency). Since *wavelength* and *frequency* are tied together through a simple directly inverse relationship, the two terms actually describe the same concept.

Signal transmission through fiber optic systems becomes increasingly difficult as the data rate on an optical channel increases. Dispersion effects become more significant at higher speeds, and can limit transmission distances, depending on the type of fiber.

The faster the channel rate, the shorter the distance signals can travel. Thus 2.5 Gbit/s signals can go farther than the 10 Gbit/s signals, and 40-Gbit/s signals cannot go as far as 10 Gbit/s. Thus one way to achieve higher overall transmission rates over the same distance is to break the signal into many parallel optical channels and transmit them at different wavelengths through the same fiber.

LEVEL	STS	STM	SDH/SONET	DS-3 Channels	Voice Channels
OC-1	STS-1		51.84 Mbps	1	672
OC-2*			103.68 Mbps	2	1,344
OC-3	STS-3	STM-1	155.52 Mbps	3	2,016
OC-4		STM-3	207.36 Mbps	4	2,688
OC-9*	STS-9	STM-3	466.56 Mbps	9	6,048
OC-12	STS-12	STM-4	622.08 Mbps	12	8,064
OC-18*	STS-18	STM-6	933.12 Mbps	18	12,096
OC-24	STS-24	STM-8	1.244 Gbps	24	16,128
OC-36	STS-36	STM-12	1.866 Gbps	36	24,192
OC-48	STS-48	STM-16	2.488 Gbps	48	32,256
OC-96*	STS-96	STM-32	4.976 Gbps	96	64,512
OC-192	STS-192	STM-64	9.953 Gbps	192	129,024
OC-768	STS-768	STM-256	39.812 Gbps	768	516,096

Figure 8-11 – Synchronous Digital Hierarchy

WDM can simplify signal processing by assigning signals generated by other equipment to their own optical channels. If your long-distance system receives signals at 2.5 Gbit/s, for example, you could transmit those signals directly in optical form on separate optical channels. This may be simpler and cheaper than time-division multiplexing them to generate single channels at 10 Gbit/s or 40Gbit/s.

Another extension of that idea is using WDM to offer many separate optical channels to different customers. Instead of selling transmission capacity at a series of different data rates, a carrier could lease separate optical channels on the same fiber to different customers. This would allow customers to transmit signals in whatever format they wanted, instead of limiting them to formats compatible with the carrier's transmission system.

The important point to remember is that WDM is not merely a way to squeeze more bits per second through the same optical fibers. WDM also is a fundamentally different way to organize signals, which may offer particular advantages.

The transmission capacity of a WDM system depends on the data rates of individual optical channels, the spacing between them, and the total range of usable wavelengths. Channel spacing depends on the optics and the characteristics of each optical channel, particularly its spectral bandwidth. The range of wavelengths available depends on the characteristics of optical amplifiers used in the system. The total capacity

is the product of the number of usable optical channels times the data rate on each channel.

The spectral bandwidth of an optical channel increases with the data rate it carries. This means that high-speed signals cannot be packed together as tightly as lower-speed signals. This fundamental tradeoff means that faster signals generally require broader channel spacing than slower signals. The exact spacing depends on the transmitter and the optics. 1 Gbit/s on optical channels are separated by a mere 1 GHz, and 40 Gbit/s signals are spaced at 100 GHz.

Dense and Course WDM

Dense wavelength-division multiplexing is important for high-performance systems, but course or wide WDM can be a way of reducing transmission costs or increasing data rates possible over a given distance.

Typically, course WDM means systems with optical channels separated by at least 10000GHz (8 nm at 1550nm). Often the spacing is 10 to 20 nm near 850, 1310, or 1550 nm for use in glass fibers, but some systems have been developed for use in plastic fiber at visible wavelengths. Wide spacing allows for the use of inexpensive laser sources with minimal temperature stabilization, as well as lower-cost wavelength separation optics.

Like other types of wavelength-division multiplexing, coarse WDM allows four course-WDM channels at 2.5 Gbit/s can carry 10-Gigabit Ethernet through up to 300 meters of 62.5/125 multimode graded-index fiber at 1300 nm, or through up to 100 km of single mode fiber as shown in figure 8-12.

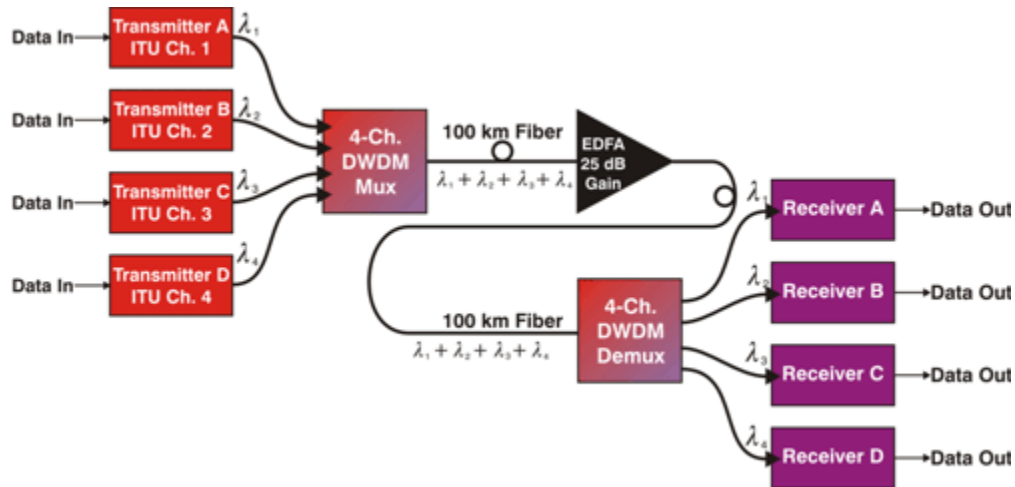

Figure 8-12. – Course wave division multiplexing system

The coarse WDM transmitters will be built around uncooled distribution-feedback lasers operating at wavelengths of 1275.7, 1300.2, 1324.7, and 1349.2 nm. The broad

range of wavelengths is possible because no amplifiers are needed for the distances envisioned for 10-Gigabit Ethernet. Loose wavelength tolerances and avoiding the need for cooling should increase yields and lower costs. The lasers could operate at temperatures of 0 to 70° C, with wavelength drifting no more than 5 nm, keeping them in the proper coarse-WDM slots. Common transmitters and receivers could be used for either single or multimode fiber.

Q16. What type of multiplexing is described by its wavelength?

Q17. What is the spacing of a 40-Gbit/s channel?

Q18. What transmitted wavelengths do course wave lasers operate at?

\

PASSIVE OPTICAL NETWORKS (PON)

Passive - means that there are no active components between the service provider and subscriber. *Optical*- says there are no electrical or electronic components in the network; it is purely photonic in nature. *Network* - tells us the system is using a fabric of elements that work together to support the transfer of information.

Today it seems that everyone wants high-speed data, dependable voice service and high-quality video. Whether these services are delivered by digital subscriber line (DSL), cable modems or wireless architectures is insignificant as long as the service is fast and dependable. Providing these services, however, presents a number of challenges, including how to get lines out to each customer and how to future-proof the architecture put into the ground today.

Hurricane Sandy was a tell-tale sign of things to come for existing copper infrastructure in this country. Most of the land lines along the coast of New Jersey and Long Island were wiped out leaving thousands of homes without phone service. The provider/maintainer of those lines told residents that the replacement and/or repair was cost prohibitive and would be replaced with a Passive Optical Network. As our aging copper networks become unstable or unmanageable they will all be replaced with this new solution.

The **Passive Optical Network (PON)** is an access network designed to provide the bandwidth capacity of optical fiber at a cost that is competitive with a copper access network. The PON is a fiber optic network that uses a passive optical splitter to connect an optical port in the CO with up to 32 subscribers. The network itself consists of a distribution cable routed from the CO to the subscriber neighborhood. In the vicinity of the subscriber the optical fiber is connected to a passive optical splitter. Here the optical signal is divided into 32 identical signals. These signals that are routed to individual

subscribers using fiber optic drop cables. Optical signals from the subscriber to the CO travel in the reverse path.

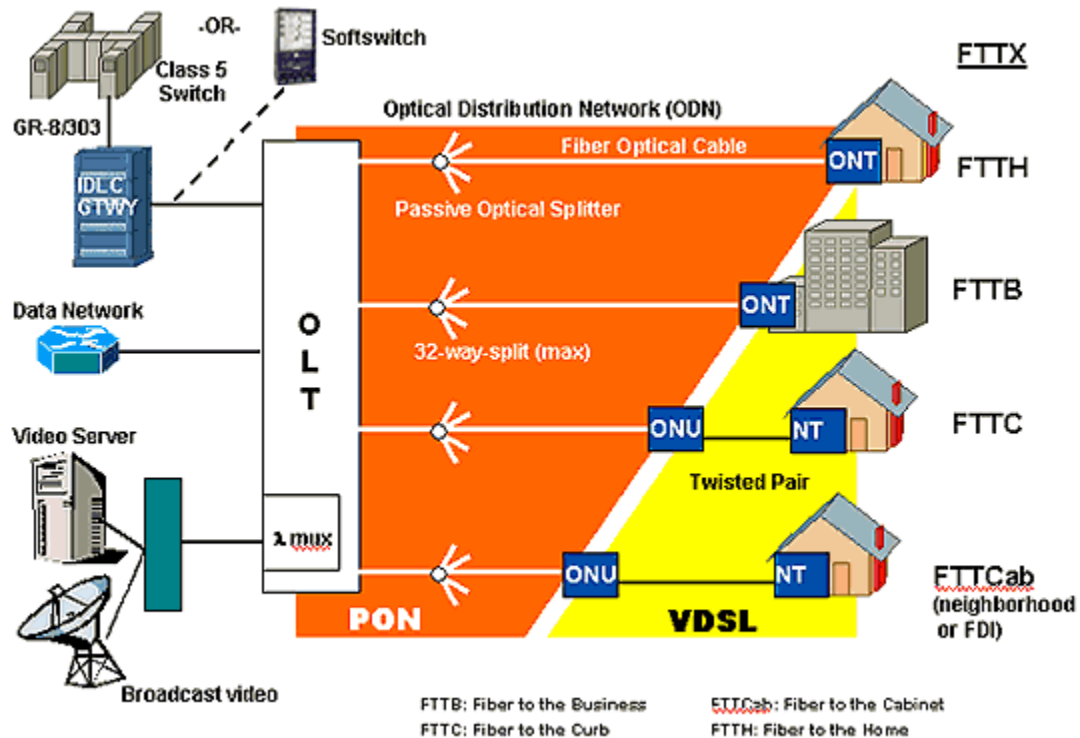

Figure 8-13. – Passive Optical Network

At the heart of a passive optical network is a passive optical splitter as shown in figure 8-13 and 8-14. This device has a single input and multiple outputs. Typically the number of outputs is 2^n (e.g. 2, 4, 8, etc.) and the optical power is split evenly between outputs. As a rule of thumb the optical power at each outputs is reduced relative to the input by a factor of $(n \times 3.5 \text{ dB})$. An optical splitter is a bi-directional device. Not only do optical signals travel from the input to the outputs, they can also traverse from the outputs to the input fiber. Because of this the splitter is sometimes referred to as a splitter/coupler. When an optical signal is inserted into one of the splitter outputs the signal will reappear on the single input. In a properly manufactured splitter there is no cross talk between output ports. The optical signal is attenuated by the same amount $\sim (n \times 3.5 \text{ dB})$ for both directions.

For reference, the communication path from the CO to the subscriber is referred to as the downstream signal. The communication path from the subscriber to the CO is referred to as the upstream signal. There are two techniques for manufacturing splitters: Fused Biconical Taper (FBT) and Planar Lightwave Circuit (PLC). A 1x2 FBT splitter is made by precisely fusing two fibers together. Higher split ratios are achieved by cascading multiple 1x2 splitters. A PLC splitter consists of a microscopic optical circuit that is typically etched in silicon. The splitters are housed in Fiber Distribution Hubs as shown in figure 8-14. These hubs take the single fiber optic signal from the CO and split it into paths of up to 32 separate lines out to the individual ONT.

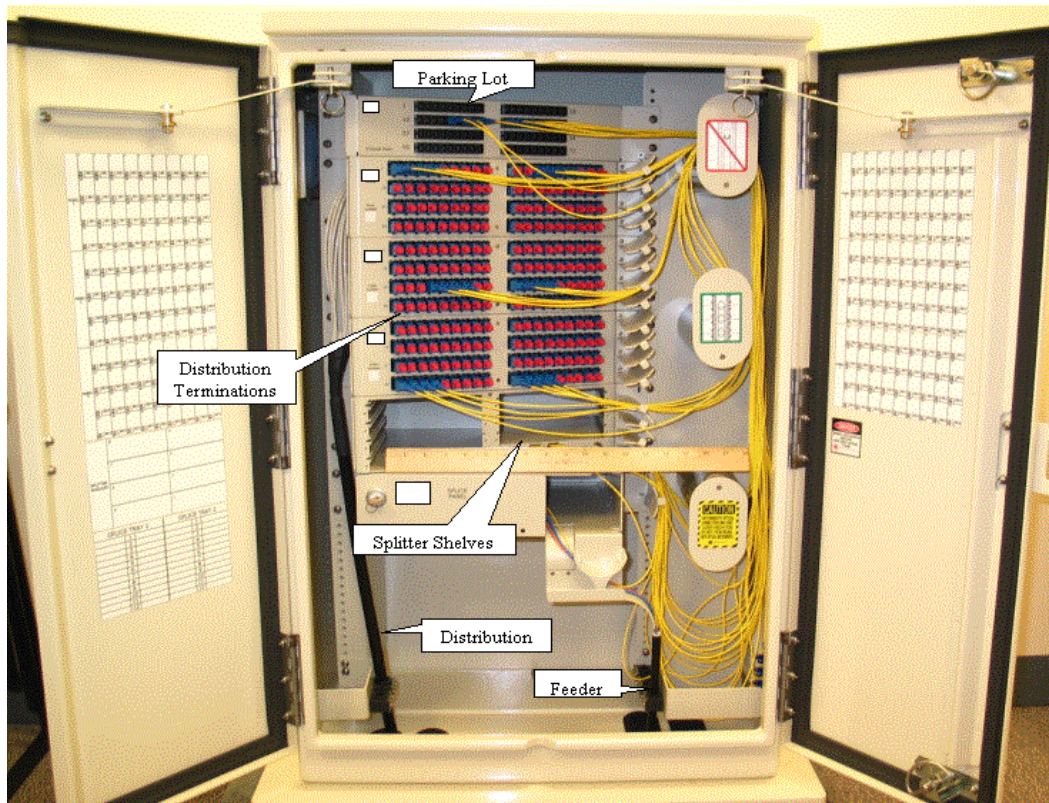

Figure 8-14. –Fiber Distribution Hub (FDH)

In most PON applications the downstream and upstream optical signals are carried over the same fiber. The wavelengths of these two signals can be the same or different. Using different wavelengths for the downstream and upstream signals reduces the total optical loss of the PON and for this reason it is the most commonly used technique. In fact all of the international PON standards (see below) specify 1490 nm for the downstream wavelength and 1310 nm for the upstream wavelength.

The signals are inserted or extracted from the fiber using a coarse wavelength division multiplexer (CWDM) filter at the CO and subscriber premises. An optical diplexer is a device specifically designed for PONs that combines the laser transmitter, the photodiode receiver, and the CWDM filter into a single package. Diplexers used in the CO have a 1490 laser and a 1310 receiver. Diplexers used at the subscriber premises have a 1310 laser and a 1490 receiver.

The 1490 and 1310 nm signals are transmitted using baseband or on-off-keying signaling. For this signal technique a digital '1' is transmitted when the laser is on and a digital '0' is transmitted when the laser is off. Because this baseband signal occupies all frequencies, there is only one signal available per wavelength [In other words, there is frequency division multiplexing with baseband signaling as there is with AM-VSB]. Voice and data are transmitted and received on the 1490 and 1310nm wavelengths.

In addition to the downstream and upstream baseband signals, a PON can also carry a broadband overlay on a third wavelength. This wavelength overlay is typically used to transport RF video at 1550 nm. Unlike the baseband signal, this broadband overlay is an analog signal. It is worth emphasizing that while it may contain analog data, digital data, or both, the signal itself is analog. For this reason the optical power of the wavelength overlay is roughly 100 times greater than the baseband signal.

The PON has a unique architectural feature in that in the downstream direction the PON behaves as a point-to-multipoint network and in the upstream the PON behaves as a point-to-point network. Because of this, separate PON protocols have been developed to accommodate this unique feature. Before discussing details of the different International standards governing PONs, it is helpful to discuss the basic functions that a PON protocol performs.

Any discussion of PON protocols involves two standard acronyms that identify the CO equipment and the subscriber equipment. These are the OLT for Optical Line Terminal and the ONT for Optical Network Terminal for the CO and subscriber equipment, respectively. See figure 8-15. While it is unfortunate that OLT and ONT differ by only one letter, the industry has made it obligatory that one commits these acronyms to memory.

Because the downstream is a point-to-multipoint network, PON protocols necessarily employ a master/slave architecture where the OLT is the master and the ONTs are slaves. In this architectural framework the OLT performs three fundamental functions:

- 1) it handles all the OAM&P for the ONTs;
- 2) it controls and coordinates all upstream transmissions by the ONTs;
- 3) when sending downstream data, the OLT must label each packet with the ID of the intended recipient.

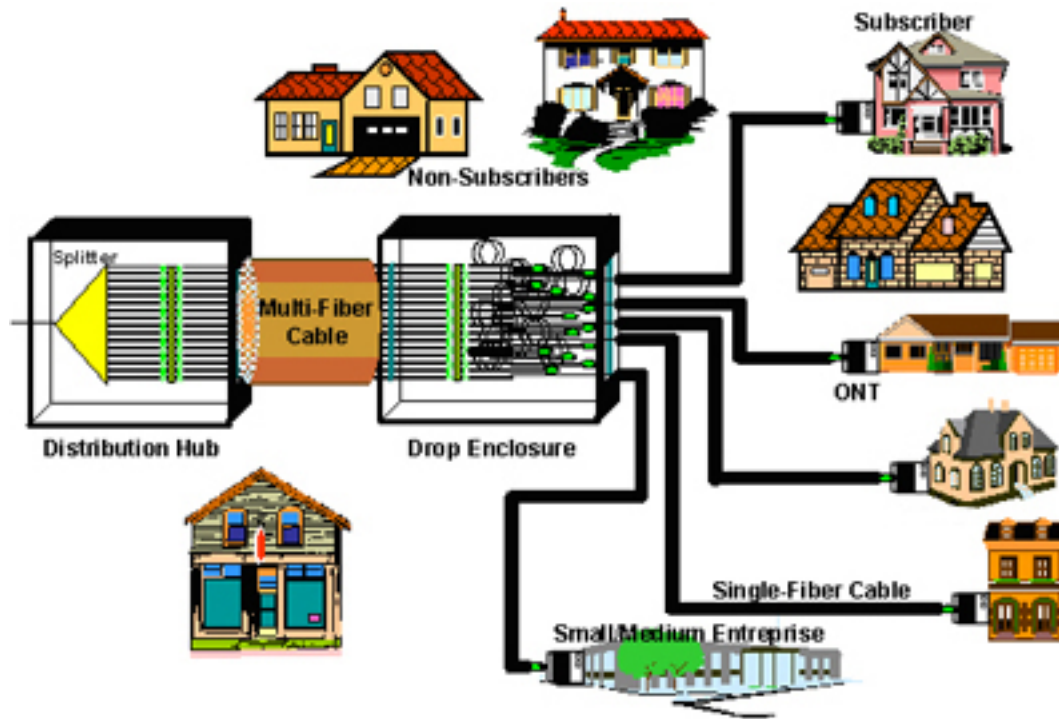

Figure 8-15. – Link between FDH and the ONT

The OAM&P consists of admitting new ONTs to the PON and provisioning services. It also includes the function of ranging. Ranging is the process whereby the optical delay between the OLT and a given ONT is determined. The optical delay is different for each ONT because the physical length of fiber is different for each. The OLT controls and coordinates all ONT transmissions using an upstream bandwidth map. This map is broadcast to all ONTs. The upstream bandwidth map combined with the ONT's range delay ensures that all upstream transmissions are received without overlap and without unnecessary gaps.

Q19. Describe the term Passive Optical Network.

Q20. What is the maximum number of channels that a signal can be split by the Passive Optical splitter?

Q21. At what wavelength is video RF added to the PON signal?

Q22. What are the two standard acronyms that describe the CO and subscriber equipment?

International PON Standards

There are three competing standards with respect to PONs: BPON, GPON, & EPON. The first two are governed by the ITU-T and the third is governed by the IEEE. BPON is designated ITU-T G.983. It was first ratified in October 1998. It was a first attempt at a PON standard. As such it has both strengths and weaknesses. Its strengths are that it established the general requirements for PON protocols. Its weakness were two-fold:

- 1) It established ATM as the sole underlying transport mechanism;
- 2) it established optical performance criteria that, to this day, are difficult if not impossible to meet at higher bandwidths.

The first BPON recommendation was G.983.1. Because this protocol allowed only ATM transport using baseband signaling it was designated APON for ATM PON. In February 2001, when the 1550 nm overlay was added with G.983.3, the name was changed to BPON for Broadband PON. Like DSL, APON/BPON was developed at a time when ATM was expected to supplant IP/Ethernet as the dominant protocol. History has shown that not to be the case. So today the fundamental reliance of BPON on ATM has turned out to be an unnecessary burden to support. It, furthermore, has made the migration of BPON-based systems from ATM to all-IP a problematic proposition.

The optical requirements established by BPON have also proven to be problematic. It is specifically the upstream overhead burst that is at issue. During normal operation of a PON, each ONT turns on its laser, transmits a short burst of data and then shuts its laser off. This is referred to as burst mode operation. Because the ONTs are at different distances and optical loss points on the PON, the upstream receiver in the OLT must accommodate a considerable range of optical powers and clock phases as the different ONTs burst on and off. In order for the OLT to adjust to these changes during clock and data recovery, the ONTs send a series of ones and zeros before sending valid data. The length of this one-zero pattern is called the Burst Overhead Time.

For BPON this burst overhead time was specified at 3 bytes (or 24 bits). There are two upstream data rates specified in the BPON recommendation: 155 & 622 Mbps. While the 3-byte overhead is adequate to perform clock and data recovery at 155 Mbps it is not adequate at 622 Mbps and higher. Considerable effort has been spent studying ways to relax the 3-byte overhead at higher data rates but no consensus has ever merged. Given that the ITU now has a next-generation PON protocol that replaces it, BPON will only ever be a 155 Mbps upstream protocol. This next-generation ITU protocol is GPON and is designated ITU-T G.984. GPON retains the strengths of BPON and corrects its weaknesses. GPON allows both ATM cells and Ethernet frames to be transmitted on the same PON. Furthermore, it allows for longer burst overhead times at higher upstream data rates. From the perspective of the optical receiver, GPON enables upstream speeds of 622 Mbps, 1.2 Gbps and 2.4 Gbps.

The IEEE has developed an Ethernet-based protocol referred to as EPON. It is part of the IEEE Ethernet in the Last Mile (EFM) initiative and is designated 802.3ah. This standard uses a 1.25 Gbps data rate for both upstream and downstream. An OLT supports 16 ONTs at a range of 10 km. The transport mechanism for EPON is obviously Ethernet. Quality of service is left to higher layer protocols. Which of the above three protocols will become the industry standard remains to be seen. All three enjoy some level of acceptance.

The passive optical network promises to deliver virtually unlimited bandwidth to the subscriber at an initial installation cost comparable to that of copper. There are significant differences between a PON and a copper network that must be mastered by the operator. The PON is a point-to-multipoint network whereas the legacy copper plant is point-to-point. The PON requires its own protocol and there are three standards to choose from. A PON enables an operator to deliver a true triple play offering of voice, video and data. An important component of the data offering can be IPTV. In spite of the challenges, the future of PON is bright indeed. Some of the applications in the home or business that PON will deliver are:

- Video on demand (VOD)
- Internet access
- Information
- Home shopping
- Video conferencing
- Distance learning
- Work at Home

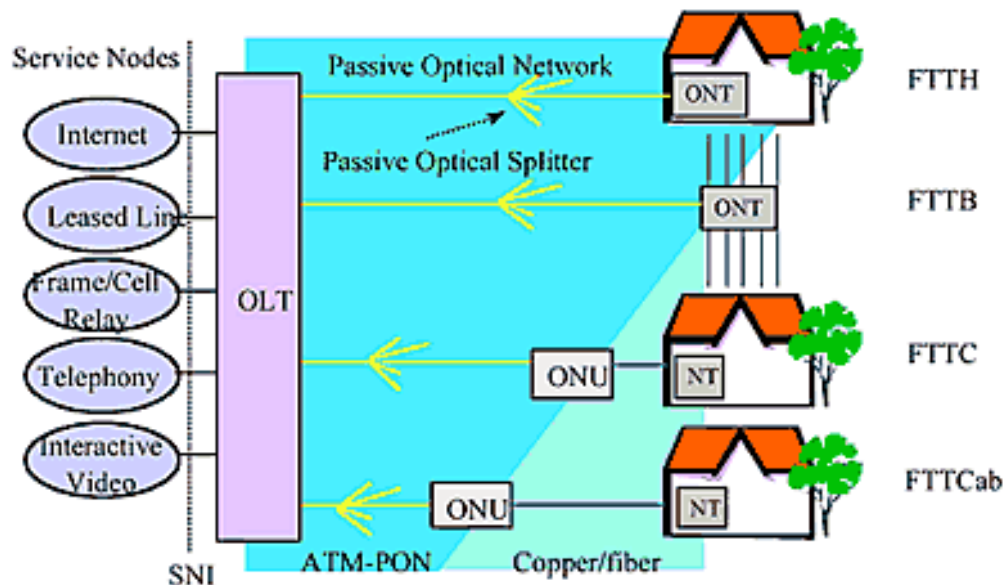

Figure 8-16. - FTTx

The full-service access network (FSAN) initiative, whose objective is to obtain cost-effective solutions to accelerate the introduction of broadband services into the

public network, is also testing asynchronous transfer mode (ATM) – passive optical network (PON) technology for FTTH, which transports network services in ATM cells on a PON. This mode of transport provides key service features, such as multiple quality-of-service (QoS) guarantees, which enables the successful transmission of integrated voice, video and data services by prioritizing traffic. It also permits statistical multiplexing for bursty traffic, such as Internet access and data transfers.

Broadband is being deployed to customers through a fiber-in-a-loop concept called FTTx. The network that provides this service from the CO or Central Office to the premises is called the local loop, as opposed to interoffice links between telephone central offices or between CATV head ends. There are many approaches for deploying fiber and how far into the loop to bring it. See figure 8-16. The term FTTx is being used to describe many aspects of fiber-to-the-premises as listed below.

- FTTC- Fiber to the Curb. Fiber is run to a node in the neighborhood. Copper (i.e., UTP or coax) is run to the premises.
- FTTH- Fiber to the Home. Fiber is run to the Optical Network Termination (ONT) on the outside wall.
- FTTB- Fiber to the Building. Used for MTUs (Multi-Tenant Units), e.g., apartment buildings and mixed-use high rises.

FTTH has been developed in response to several residential access market drivers, including:

- The Internet explosion, second line growth, the desire for higher speeds, alternative strategies such as voice over DSL (VoDSL), voice over IP (VoIP), voice over ATM (VoATM), and cable modems
- The increased competition in the market due to the growing number of competitive local-exchange carriers (CLECs), an increase in services offered by application service providers (ASPs) and deregulation and pending Federal Communications Commission (FCC) rulings
- Turn-up complexities that affect ease of deployment and maintenance
- The declining costs of optical equipment
- Technology life cycles that dictate a need to deploy the right technology at the right time and to future-proof existing networks

Q23. What protocol is used in BPON transmissions?

Q24. What are the upstream transmission speeds of GPON?

Q25. What does the acronym FTTx describe?

SYSTEM DESIGN

Fiber optic systems can be simple point-to-point data links or can involve more complex topologies. However, it is generally necessary only to refer to point-to-point data links when discussing the process of link design. Fiber optic systems that incorporate complex architectures can be simplified into a collection of point-to-point data links before beginning the design process.

Fiber optic system design is a complicated process that involves link definition and analysis. The design process begins by providing a complete description of the communication requirements. This information is used to develop the link architecture and define the communications links. System designers must decide on the operational wavelength and types of components to use in the system. These decisions affect numerous system and link design parameters, such as launched power, connection losses, bandwidth, cost, and reliability.

Once a system design has been formulated, each link is analyzed to determine its viability. Link analysis involves calculating each link's power budget and rise time budget. Calculating a **power budget** involves identifying all of the sources of loss in the fiber optic link. These losses and an additional safety margin are then compared to the difference between the transmitter output power and the receiver sensitivity. The difference between the transmitter output power and the receiver sensitivity is referred to as the **available power**. If the sources of loss plus the safety margin are less than the available power in the link, the design is viable.

Calculating the **rise time budget** involves calculating the rise times of the link transmitter and the optical fiber. The composite optical transmitter/fiber rise time is referred to as the **fiber exit rise time**. If the fiber exit rise time is less than the maximum input rise time specified for the link receiver, then the link design is viable.

If a proposed link design is not viable, the system designer will reevaluate various decisions made earlier in the system design. These reevaluations may include using a different transmitter or receiver or may involve redesigning the physical configuration of the link. Because there are many variables involved in link design and analysis, it may take several iterations before the variables are combined in a manner that ensures link operation. For more information of fiber optic system design, refer to the *Navy Fiber Optic System Design Standard*.

Q26. Why is it generally only necessary to refer to point-to-point data links when discussing the process of fiber optic system design?

Q27. List five system design parameters considered when system designers choose the system operational wavelength and link components.

Q28. What two analyses are performed to determine if a link design is viable?

SYSTEM INSTALLATION

The Navy has a standard to provide detailed information and guidance to personnel concerned with the installation of fiber optic cable plants on naval surface ships and submarines. The **fiber optic cable plant** consists of all the fiber optic cables and the fiber optic interconnection equipment within the ship, including connectors, splices, and interconnection boxes. The fiber optic cable plant installation standard consists of a basic standard and six numbered parts dealing with the following:

- Cables-provides detailed methods for cable storage and handling, end-sealing, repair, and splicing
- Equipment-provides detailed methods for fiber optic equipment installation and cable entrance to equipment
- Penetrations-provides detailed methods for cable penetrations within the ship's structure
- Cableways-provides detailed methods to install fiber optic cables in cableways
- Connectors and interconnections-provides detailed methods for installing fiber optic connectors and other interconnections, such as splices
- Tests-identifies and provides detailed methods for testing fiber optic cable plants before, during, and after installation and repair

There are other standards that discuss fiber optic system installation. Many of these standards incorporate procedures for repair, maintenance, and testing. The techniques developed for installing fiber optic hardware are not much different than for installing hardware for copper-based systems. However, the primary precautions that need to be emphasized when installing fiber optic systems on board ships are as follows:

- Optical fibers or cables should never be bent at a radius of curvature less than a certain value, called the **minimum bend radius**. Bending an optical fiber or cable at a radius smaller than the minimum bend radius causes additional fiber loss.
- Fiber optic cables should never be pulled tight or fastened over or through sharp corners or cutting edges. Extremely sharp bends increase the fiber loss and may lead to fiber breakage.
- Fiber optic connectors should always be cleaned before mating. Dirt in a fiber optic connection will significantly increase the connection loss and may damage the connector.
- Precautions must be taken so the cable does not become kinked or crushed during installation of the hardware. Extremely sharp kinks or bends increase the fiber loss and may lead to fiber breakage.
- Only trained, authorized personnel should be allowed to install or repair fiber optic systems.

Q29. Optical fibers or cables should never be bent at a radius of curvature smaller than a certain value. Identify this radius of curvature.

Q30. List five precautions to take when installing fiber optic systems on board naval ships.

SUMMARY

Now that you have completed this chapter, let's review some of the new terms, concepts, and ideas that you have learned. Understanding the basics of fiber optic system classification, design, and installation is recommended before you begin studying specific fiber optic system applications.

Full Service Access Network (FSAN) is an initiative developed by an international consortium of telecommunications vendors. Subsequently ratified by the ITU-T as G.983.1 standard (October 1998), FSAN was the basis for PON.

The **International Telecommunications Union (ITU)** was formed in 1865 to ensure the interoperability of national telegraph networks. The ITU sets standards recommendations for a wide variety of wire line and wireless network technologies, including PON.

The **Institute of Electrical and Electronics Engineers (IEEE)** is a professional organization that is involved in many aspects of electrical and electronics engineering, including the establishment of standards, largely focusing on the Local Area Network (LAN) domain.

ATM PON (APON) is the term applied to the original specifications set by FSAN and ratified by the ITU-T in the G.983 series. APON specifies ATM (Asynchronous Transfer Mode) as the underlying bearer protocol. APON specifications also include local loop lengths, transport speeds, optical splits, multiplexing techniques and maximum loss levels. WDM uses 1550nm wavelength for downstream voice and data and 1310nm wavelength for upstream voice and data.

Ethernet Passive Optical Network (EPON) is a set of specifications established by the IEEE 802.3 committee, which develops data communications standards for the LAN (Local Area Network) and MAN (Metropolitan Area Network) domains. EPON leverages existing Ethernet standards, which specify data rates of 10/100/1000 Mbps, with the last commonly known as Gibe. 10GbE PON standards are under development.

Asynchronous Transfer Mode (ATM) is a fast-packet, connection-oriented cell-switching technology for broadband signals. ATM is designed to support any and all types of information, including voice, facsimile, data and video, whether uncompressed or compressed, and real-time or non-real-time.

A basic **POINT-TO-POINT** fiber optic data link consists of an optical transmitter, optical fiber, and an optical receiver. In addition, any splices or connectors used to join individual optical fiber sections to each other and to the transmitter and the receiver are included.

The term **TOPOLOGY** refers to the configuration of various equipment's and the fiber optic components interconnecting them.

A **LINEAR BUS TOPOLOGY** consists of a single transmission line that is shared by a number of equipment's.

A **RING TOPOLOGY** consists of equipment's attached to one another in a closed loop or ring.

In the **STAR TOPOLOGY**, each equipment is connected to a common center hub. The center hub can be a passive fiber optic star coupler or an active equipment.

A **TREE TOPOLOGY** consists of a transmission line that branches, or splits.

FIBER OPTIC LINKS are classified according to the modulation type: either digital or analog.

DIGITAL MODULATION implies that the optical signal consists of discrete levels.

ANALOG MODULATION implies that the intensity of the optical signal is proportional to a continuously varying electrical input.

MODULATION is the process of varying one or more characteristics of an optical signal to encode and convey information.

A **DIGITAL SIGNAL** is a discontinuous signal that changes from one state to another in discrete steps.

BINARY, or two level, digital modulation is a popular form of digital modulation.

LINE CODING is the process of arranging symbols that represent binary data in a particular pattern for transmission. The most common types of line coding used in fiber optic communications include nonreturn- to-zero (NRZ), return-to-zero (RZ), and biphase, or Manchester.

DIGITAL TRANSMISSION offers an advantage with regard to the acceptable SNR at the optical receiver.

An **ANALOG SIGNAL** is a continuous signal that varies in a direct proportion to the instantaneous value of a physical variable.

Most **ANALOG FIBER OPTIC COMMUNICATIONS SYSTEMS** intensity modulate the optical source.

In **INTENSITY MODULATION**, the intensity of the optical source's output signal is directly modulated by the incoming electrical analog baseband signal.

A **BASEBAND SIGNAL** is a signal that is in its original form and has not been changed by a modulation technique.

FIBER OPTIC SYSTEMS that have complex architectures can be simplified into a collection of point-to-point data links.

LINK ANALYSIS involves calculating each link's power budget and rise time budget.

Calculating a **POWER BUDGET** involves identifying all of the sources of loss in the fiber optic link. These losses and an additional safety margin are then compared to the difference between the transmitter output power and the receiver sensitivity.

Calculating the **RISETIME BUDGET** involves calculating the rise times of the link transmitter and the optical fiber.

The **FIBER OPTIC CABLE PLANT** consists of all the fiber optic cables and the fiber optic interconnection equipment within the ship, including connectors, splices, and interconnection boxes.

OPTICAL FIBERS or **CABLES** should never be bent at a radius of curvature less than a certain value, called the minimum bend radius.

FIBER OPTIC CONNECTORS should always be cleaned before mating.

ANSWERS TO QUESTIONS Q1. THROUGH Q17.

- A1. *Linear bus, ring, star, and tree topologies.*
- A2. *Ring.*
- A3. *Star.*
- A4. *IEEE standard 802.3*
- A5. *In half-duplex mode the maximum distance is 2km for either multimode or single mode fiber.*
- A6. *Token Ring*
- A7. *The process of varying one or more characteristics of an optical signal to encode and convey information.*
- A8. *A discontinuous signal that changes from one state to another in discrete steps.*
- A9. *Binary 1.*
- A10. *If a long string of 1s or 0s are present causing a lack of level transitions.*
- A11. *A half-period optical pulse present in the first half of the bit duration.*
- A12. *Binary 0.*
- A13. *A continuous signal that varies in a direct proportion to the instantaneous value of a physical variable.*
- A14. *Intensity modulation.*
- A15. *Because cost can be minimized and complex multiplexing and timing equipment is unnecessary.*
- A16. *Wavelength-division multiplexing.*
- A17. *40Gbit/s signals are spaced at 100 GHz.*
- A18. *Course WDM transmitters operate at wavelengths of 1257.7, 1300.2, 1324.7, and 1349.2nm.*
- A19. *PON describes a network where there are no active components between the service provider and subscriber, there are no electrical or electronic components, and it uses a fabric of elements that work together to support the transfer of data.*

- A20. *A passive splitter has a maximum of 32 output channels.*
- A21. *The video RF overlay is placed on a 1550nm wavelength.*
- A22. *OLT – Optical Line Terminal identifies the equipment at the central office or CO. ONT – Optical Network Terminal describes the equipment at the subscriber end.*
- A23. *ATM is used as the protocol for BPON standard.*
- A24. *The upstream transmission speeds of GPON are 622Mbps, 1.2Gbps and 2.4Gbps.*
- A25. *The terms FTTC – Fiber to the Curb, FTTH – Fiber to the Home, FTTB – Fiber to the Building, are used to describe FTTx.*
- A26. *Because fiber optic systems that incorporate complex architectures can be simplified into a collection of point-to-point data links before beginning the design process.*
- A27. *Launch power, connection losses, bandwidth, cost, and reliability.*
- A28. *Power budget and rise time budget.*
- A29. *Minimum bend radius.*
- A30.
- a. Never bend an optical fiber or cable at a radius of curvature less than the minimum bend radius.*
 - b. Never pull fiber optic cables tight or fasten them over or through sharp corners or cutting edges.*
 - c. Always clean fiber optic connectors before mating.*
 - d. Do not kink or crush fiber optic cable during installation of the hardware.*
 - e. Allow only trained, authorized personnel to install or repair fiber optic systems.*

ASSIGNMENT 1

Textbook assignment: Chapter 1, "Background on Fiber Optics,"
Chapter 2, "Fiber Optic Concepts"

- 1-1. Fiber optics uses what medium to send information?
 1. Electrons
 2. Phonons
 3. Link 11
 4. Light

- 1-2. What are the four parts of a fiber optic data link?
 1. Transmitter, optical fiber, connectors/splices, receiver
 2. Transmitter, optical fiber, data, optical connectors
 3. Optical fiber, data, optical connectors, receiver
 4. Optical fiber, optical connectors, optical splices, data

- 1-3. The fiber optic transmitter has which of the following functions?
 1. Amplifies the optical signal
 2. Converts the electrical input signal to an optical signal
 3. Converts the input optical signal to an electrical signal
 4. Amplifies the output electrical signal

- 1-4. Fiber optic systems use what three types of optical sources?
 1. LEDs, LASERs and VCSELs
 2. PIN diodes, LASERs and LEDs
 3. LEDs and LASERs and diodes
 4. LASERs, diodes and APDs

- 1-5. What type of fiber does a VCSEL require for its transmission medium?
 1. Single mode fiber
 2. Dispersion shifted fiber
 3. Multimode Fiber
 4. Laser optimized multimode fiber

- 1-6. What transmitter uses stimulated emission?
1. LED
 2. LASER
 3. VCSEL
 4. APD
- 1-7. A Laser differs from ordinary light in three distinct ways. Its coherent, directional and monochromatic.
1. True
 2. False
- 1-8. The fiber optic receiver performs which of the following functions?
1. Amplifies the optical signal
 2. Amplifies the electrical signal
 3. Converts the electrical signal back into an optical signal
 4. Converts the optical signal back into an electrical signal
- 1-9. What are the two types of optical detectors?
1. LEDs and APDs
 2. PIN photodiodes and APDs
 3. APDs and laser diodes
 4. Laser diodes and PIN photodiodes
- 1-10. What photodiode has a one-to-one relationship with the photons, carriers and current?
1. LED
 2. APD
 3. PIN
 4. BER
- 1-11. What component in the fiber link is about 10 times more sensitive and can respond better to faster incoming light?
1. LED
 2. APD
 3. PIN
 4. BER

1-12. Who developed the first optical telegraph?

1. Kapany
2. Tyndall
3. Chappe
4. Wheeler

1-13. Who demonstrated the concept of “Total Internal Reflection?”

1. Kapany
2. Tyndall
3. Chappe
4. Wheeler

1-14. When was the first fiber optic system installed on a US Navy ship?

1. 1973
2. 1976
3. 1977
4. 1985

1-15. When was the first commercial fiber optic telephone systems installed?

1. 1973
2. 1976
3. 1977
4. 1985

1-16. The installation standard (MIL-STD) for ships is _____.

1. NSTM Chapter 408
2. MIL-STD 2052
3. MIL-STD 2016
4. MIL-STD 2042

1-17. Of the following advantages, which one does NOT apply to fiber optics?

1. Lower signal attenuation
2. Increased bandwidth
3. Improved environmental
4. Reduced size and weight

- 1-18. To describe the nature of light, which of the following ways can be used?
1. Electromagnetic wave only
 2. Particles of energy only
 3. Electromagnetic wave and particles of energy
 4. Element
- 1-19. Light exhibits what kind of wave motion?
1. Longitudinal
 2. Transverse
 3. Turbulent
 4. Aperiodic
- 1-20. Which of the following factors is a description of transverse wave motion?
1. The wave motion is not predictable
 2. The wave magnitude varies parallel to the direction of propagation
 3. The wave magnitude varies perpendicular to the direction of wave motion
 4. Radiates in straight lines
- 1-21. What does a transparent substance do to light rays that fall on it?
1. Absorbs them
 2. Reflects them
 3. Refracts them
 4. Transmits them
- 1-22. What does a translucent substance do to light rays that fall on it?
1. Reflects and absorbs them
 2. Refracts and absorbs them
 3. Transmits and diffuses them
 4. Transmits and reflects them
- 1-23. Which of the following substances is a good example of a translucent substance?
1. Cardboard
 2. Clear glass
 3. Frosted glass
 4. Aluminum foil

1-24. Which of the following substances is a good example of a transparent substance?

1. Cardboard
2. Clear glass
3. Frosted glass
4. Aluminum foil

1-25. What does an opaque substance do when light rays fall on it?

1. Refracts them
2. Reflects or absorbs them
3. Transmits them only
4. Transmits and diffuses them

1-26. Which of the following substances is an example of an opaque substance?

1. Cardboard
2. Clear glass
3. Oiled paper
4. Frosted glass

1-27. Which of the following objects is NOT an example of a luminous source?

1. Sun
2. Gas flame
3. Mirror
4. Flashlight

1-28. What are light waves called that strike a surface but are neither transmitted nor absorbed?

1. Diffused
2. Refracted
3. Reflected
4. Diffracted

1-29. What is the name of the law that states "The angle of incidence is equal to the angle of reflection"?

1. Snell's Law
2. Murphy's Law
3. Law of Entropy
4. Law of Reflection

- 1-30. A light wave is incident on a surface. The reflected power is the greatest in which of the following incidences?
1. 30°
 2. 45°
 3. Perpendicular
 4. Almost parallel
- 1-31. A light wave passes from one medium into another medium with a different velocity. As the wave enters the second medium, the change of direction is known by which of the following terms?
1. Reflection
 2. Refraction
 3. Absorption
 4. Diffusion
- 1-32. If a light wave passes from a less dense medium to a more dense medium, how does the angle of refraction compare to the angle of incidence?
1. Greater than the angle of incidence only
 2. Equal to the angle of incidence only
 3. Greater than or equal to the angle of incidence
 4. Less than the angle of incidence
- 1-33. What is another word for diffused?
1. Absorbed
 2. Refracted
 3. Scattered
 4. Attenuated
- 1-34. When light falls on a piece of black paper, what happens to most of the light?
1. It is absorbed
 2. It is reflected
 3. It is scattered
 4. It is refracted
- 1-35. Light is transmitted along an optical fiber by what two methods?
1. Ray theory and mode theory
 2. Ray theory and photon theory
 3. Ray theory and quantum theory
 4. Mode theory and photon theory

- 1-36. How does the speed of light in the fiber compare to the speed of light in the air?
1. It is slower in the fiber
 2. It is faster in the fiber
 3. It is the same in both the fiber and the air
- 1-37. The relationship between the incident rays and the refracted rays at a boundary between mediums with different indexes of refraction describes what law?
1. Bragg's Law
 2. Snell's Law
 3. Murphy's Law
 4. Law of Reflection
- 1-38. Total internal reflection occurs at which of the following angles?
1. Obtuse angle
 2. Fresnel angle
 3. Right angle
 4. Critical angle of incidence
- 1-39. What are the three basic parts of an optical fiber?
1. Core, cladding, and coating
 2. Inside, middle, and outside
 3. Fiber, Kevlar, and jacket
 4. Hole, shell, and coating
- 1-40. The cladding performs all except which of the following functions?
1. Reduces the loss of light from the core
 2. Reduces the scattering loss at the surface of the core
 3. Protects the fiber core from absorbing surface contaminants
 4. Reduces mechanical strength
- 1-41. What is the definition of a bound ray?
1. A ray that cannot move
 2. A ray that travels in the air
 3. A ray that is refracted out of the fiber
 4. A ray that propagates through the fiber by total internal reflection

- 1-42. The fiber NA relates to which of the following characteristics?
1. Physical size of the fiber
 2. Tensile strength of the fiber
 3. Maximum angle within the fiber acceptance cone
 4. Speed of light within the fiber
- 1-43. A skew ray is which of the following types of rays?
1. An unbound ray
 2. A meridional ray
 3. An unbalanced ray
 4. A ray that propagates without passing through the center axis of the fiber
- 1-44. Electromagnetic wave behavior is used to describe the propagation of light along the fiber in what theory?
1. Mode theory
 2. Particle theory
 3. Darwin's theory
 4. Rayleigh's theory
- 1-45. High-order modes cross the axis of the fiber at steeper angles than low-order modes.
1. True
 2. False
- 1-46. Compared to a low-order mode, the electrical and magnetic fields of a high order mode are distributed more toward the center of a fiber.
1. True
 2. False
- 1-47. What are the two basic types of fibers?
1. Small and large
 2. Glass and plastic
 3. Opaque and diffuse
 4. Single mode and multimode
- 1-48. Compared to multimode fibers, single mode fibers have a larger core size.
1. True
 2. False

- 1-49. The lowest signal loss and the highest bandwidth are characteristic of which of the following types of fibers?
1. Air core
 2. Multimode
 3. Single mode
 4. Plastic core
- 1-50. Compared to single mode fibers, multimode fibers have which of the following advantages?
1. Ease of making connections only
 2. Ease of launching light into them only
 3. Ease of both making connections and launching light into them
 4. Lower dispersion
- 1-51. What ISO 11801 standard uses 50/125 μ m laser-optimized fiber to support 10 Gigabit Ethernet for up to 300 meters??
1. OM1
 2. OM2
 3. OM3
 4. OM4
- 1-52. What cable color is recommended for 50/125 μ m laser-optimized fiber?
1. Aqua
 2. Yellow
 3. Orange
 4. Grey
- 1-53. Attenuation is specified in what units?
1. dB
 2. dB/km
 3. μ m
 4. μ m/km
- 1-54. Glass optical fibers have low loss between the infrared and ultra- violet absorptive regions. The approximate wavelength of operation for glass optical fibers is in which of the following ranges?
1. 1 nm to 700 nm
 2. 700 nm to 1600 nm
 3. 1600 nm to 9000 nm
 4. 9 μ m to 20 μ m

- 1-55. Increased extrinsic absorption at 950 nm, 1,250 nm, and 1,383 nm is caused by what impurity in glass optical fibers?
1. Phosphorus
 2. Germanium
 3. Titanium
 4. Water
- 1-56. Which type of scattering loss is proportional to the reciprocal of the fourth power of the wavelength of the light?
1. Mie
 2. Raman
 3. Rayleigh
 4. Brillouin
- 1-57. A radius of curvature is larger than the fiber diameter in which of the following types of fiber bends?
1. Macrobends
 2. Microbends
 3. Gentle bends
 4. Serpentine bends
- 1-58. Only in multimode fibers does which of the following types of dispersion occur?
1. Modal
 2. Material
 3. Waveguide
 4. Chromatic
- 1-59. When different colors of light travel through the fiber at different speeds, which of the following types of dispersion occurs?
1. Modal
 2. Material
 3. Intermodal
 4. Atmospheric
- 1-60. Approximately how much light is propagating within the core of a single mode fiber?
1. 20%
 2. 40%
 3. 60%
 4. 80%

1-61. What components make up Chromatic Dispersion?

1. Material Dispersion
2. Polarization Mode Dispersion
3. Waveguide Dispersion
4. Both 1 and 3.

ASSIGNMENT 2

Textbook assignment: Chapter 3, "Optical Fibers and Cables"
Chapter 4, "Optical Splices, Connectors, and Couplers".

- 2-1. In a step-index fiber, the refractive index profile of the fiber core has which of the following characteristics?
1. It is uniform over the fiber core
 2. It linearly decreases from a maximum at the fiber center to a minimum at the core-cladding boundary
 3. It is parabolic with a maximum index of refraction at the center and a minimum index of refraction at the core-cladding boundary
 4. It linearly increases from a minimum at the fiber center to a maximum at the core cladding boundary
- 2-2. In a graded-index fiber, the refractive index profile of the fiber core is best described by which of the following statements?
1. It is uniform over the fiber core
 2. It linearly decreases from a maximum at the fiber center to a minimum at the core-cladding boundary
 3. It is parabolic with a maximum index of refraction at the center and a minimum index of refraction at the core-cladding boundary
 4. It linearly increases from a minimum at the fiber center to a maximum at the core cladding boundary
- 2-3. Which of the following multimode fiber core sizes is NOT a standard commercial fiber size?
1. 50 μm
 2. 62.5 μm
 3. 76 μm
 4. 100 μm
- 2-4. Elements other than silicon and oxygen are added to glass material by the fiber manufacturer to change its index of refraction. What are these elements called?
1. Spices
 2. Dopants
 3. Additives
 4. Impurities

- 2-5. Compared to multimode step-index fibers, do multimode graded-index fibers have lower, higher, or approximately equal bandwidths?
1. Lower
 2. Higher
 3. Approximately equal
- 2-6. In multimode graded-index fibers, is the index of refraction of the glass at the center of the fiber core lower, higher, or approximately equal to the index of refraction of the cladding glass?
1. Lower
 2. Higher
 3. Approximately equal
- 2-7. For a multimode graded-index fiber, the index of refraction is at its maximum value at which of the following locations?
1. At the fiber axis
 2. At the core-cladding interface
 3. Half way between the fiber center and the core-cladding interface
 4. One-fourth of the way between the fiber center and the core-cladding interface
- 2-8. In multimode fiber, all light rays have to propagate all of the way to the core cladding interface before they are reflected back toward the fiber axis.
1. True
 2. False
- 2-9. A step-index multimode fiber and a graded-index multimode fiber have the same core and cladding sizes and the same refractive index difference. Which fiber type, if either, will accept light more easily and have more propagating modes?
1. Step-index fiber
 2. Graded-index fiber
 3. Neither; they will behave approximately the same
- 2-10. The multimode graded-index fiber that has the best bend performance and will show the least amount of optical degradation if mishandled is what size?
1. 50/125 μm
 2. 62.5/125 μm
 3. 85/125 μm
 4. 100/140 μm

- 2-11. The attributes of the 62.5/125- μm fiber do NOT include which of the following factors?
1. Low loss
 2. High bandwidth
 3. Low bending sensitivity
 4. Low source to fiber coupling efficiency
- 2-12. What are the two basic types of single mode step-index fibers?
1. Low NA and high NA
 2. Solid core and air core
 3. Enriched clad and depressed
 4. Matched clad and depressed clad
- 2-13. For wavelengths greater than its cutoff wavelength, a typical single mode fiber is allowed to propagate a total of how many modes, if any?
1. 1 only
 2. 10 only
 3. 100
 4. None
- 2-14. Under what condition, if any, will the fiber cease to be single mode?
1. When the wavelength of the light is greater than the cutoff wavelength
 2. When the wavelength of the light is less than the cutoff wavelength
 3. None
- 2-15. The use of plastic-clad silica and all plastic fibers has what primary drawback?
1. Higher NA
 2. Higher cost
 3. Higher bandwidth
 4. Limited optical performance
- 2-16. In the fabrication of silica optical fibers, which of the following processes may be used?
1. Outside vapor phase oxidation (OVPO)
 2. Inside vapor phase oxidation (IVPO)
 3. Vapor phase axial deposition (VAD)
 4. All of the above

- 2-17. In making a preform, layers of glass powder are deposited on the inside or outside of a glass rod or tube. What is this glass powder called?
1. Soot
 2. Smoke
 3. Preform
 4. Afterburn
- 2-18. The process used in drawing the fiber is best described by which of the following statements?
1. The preform is melted and the molten glass is molded, using special fiber molds
 2. The preform is softened and the glass is pulled into a thin glass filament
 3. The preform is softened and the glass is rolled into a thin glass filament
 4. The preform is melted and the fiber is formed by blowing the molten glass through a small hole
- 2-19. To protect the fiber from contaminants in the drawing process, what substance is added over the fiber?
1. Water
 2. Coating
 3. Preform
 4. Cladding
- 2-20. Most fiber optic cable structures contain which of the following items?
1. Buffers only
 2. Jackets only
 3. Buffers and jackets only
 4. Buffers, jackets, and strength members
- 2-21. Properly designed optical cable structures perform which of the following functions?
1. Protect the optical fibers from mechanical stresses, damage, and breakage
 2. Increase the tensile stress on the fiber
 3. Decrease the attenuation of the fiber
 4. All of the above

- 2-22. The fiber buffer performs which of the following functions?
1. Protects the fiber from micro-bends
 2. Provides additional mechanical protection
 3. Helps preserve the fiber's inherent strength
 4. All of the above
- 2-23. Navy shipboard fiber optic cables should NOT contain which of the following materials as a strength member?
1. Steel wire
 2. Arimid yarns
 3. Carbon fibers
 4. Glass-reinforced plastics
- 2-24. In the materials of a Navy shipboard fiber optic cable jacket, which of the following properties is NOT desirable?
1. High abrasion resistance
 2. High flame retardance
 3. High halogen content
 4. Low toxicity
- 2-25. Most commercial fiber optic cable jacket materials are suitable for use in Navy shipboard applications.
1. True
 2. False
- 2-26. For low-density fiber Navy ship- board applications, which cable designs, if any, are preferred?
1. Stranded cable
 2. Ribbon cable
 3. OFCC cable
 4. None; they are all equally effective
- 2-27. When compared with other cable designs, the OFCC fiber optic cable has which of the following advantages?
1. Ruggedness only
 2. Ease of handling only
 3. Ruggedness and ease of handling
 4. Relative small size

- 2-28. The only advantage of the stranded cable design over the OFCC cable design is
1. greater ruggedness
 2. better fiber protection
 3. smaller size for the same fiber count
 4. better water-blocking performance
- 2-29. A particular fiber optic cable design has the highest fiber count possible in the smallest size. But it is difficult to use, shows susceptibility to fiber damage during fiber breakout, and has poor bending and water-blocking performance. Which of the following designs fits this description?
1. OFCC cable
 2. Stranded cable
 3. Ribbon cable
- 2-30. In Blown Optical Fiber, what is the maximum distance eight fibers can be blown horizontally?
1. 500ft
 2. 1000ft
 3. 3280ft
 4. 5000ft
- 2-31. A fiber optic connection that is typically intended to be permanent is what type, if any?
1. Mechanical splice
 2. Connector
 3. Coupler
 4. None; they are all intended to be removable
- 2-32. Easy coupling and uncoupling of optical fibers are allowed by what type of fiber optic connection, if any?
1. Splice
 2. Coupler
 3. Connector
 4. None; all are equally difficult

- 2-33. The distribution or combination of optical signals among fibers uses which type of fiber optic connection, if any?
1. Splice
 2. Coupler
 3. Connector
 4. None; it is not possible to distribute or combine optical signals
- 2-34. What is the number one problem in maintaining a fiber optic cable plant?
1. Poor fiber alignment
 2. Poor fiber end preparation
 3. Differences in optical properties between connected fibers
 4. Contamination
- 2-35. What minimum magnification does the Navy require when inspecting an end face? ?
1. 100X
 2. 200X
 3. 400X
 4. 800X
- 2-36. What piece of equipment is used to inspect a multi-terminus connector or at the electronics ports?
1. Video inspection probe
 2. Microscope
 3. Eye loop
 4. Interferometer
- 2-37. Where does loss come from in a fiber optic cable plant?
1. Cable loss
 2. Connector loss
 3. Splice loss
 4. All of the above
- 2-38. What are the main source (s) of intrinsic loss resulting from the manufacturing process?
1. Absorption
 2. Poor fiber alignment
 3. Scattering
 4. Both absorption and scattering

- 2-39. Insertion loss for all connectors per mated pair is?
1. .5 dB
 2. .75 dB
 3. 1.0 dB
 4. 5.0 dB
- 2-40. Which of the following conditions is NOT a form of poor fiber alignment?
1. NA mismatch
 2. Fiber separation
 3. Lateral misalignment
 4. Angular misalignment
- 2-41. For mating fibers to touch when a connector is assembled, which of the following polishing techniques was developed?
1. Fresnel polish
 2. Rayleigh polish
 3. Circular polish
 4. Physical contact polish
- 2-42. Single mode fibers are less sensitive to alignment errors than multimode fibers because of their small core size.
1. True
 2. False
- 2-43. The fiber cleaving process includes which of the following actions?
1. Cutting the fiber with a cleaver
 2. Bending the fiber until it breaks
 3. Lightly scoring the fiber outer surface and pulling it straight off
 4. Sawing the fiber with a special fiber saw
- 2-44. In Navy fiber optic applications, losses from fiber mismatches are minimized by which of the following actions?
1. Polishing the fiber ends
 2. Using index matching gels
 3. Using index matching epoxies
 4. Using Navy specification fibers with tightly specified parameters

- 2-45. Who performed the first documented fusion splice?
1. Jim Krause
 2. Dan L. Bisbee
 3. Kinoshita
 4. Kobayashi
- 2-46. What temperature are the fibers heated to perform a fusion splice?
1. 1000C
 2. 1200C
 3. 2000C
 4. 3000C
- 2-47. In single mode fibers what has to be aligned to create a good splice?
1. Cladding
 2. Buffer
 3. Coating
 4. Core
- 2-48. For shipboard applications, which of the following types of splices is recommended?
1. Fusion
 2. Rotary
 3. V-groove
 4. Ceramic alignment tube
- 2-49. What type of fiber optic connector does the Navy refer to as the “quick connect connector?”
1. Rotary
 2. Prepolished splice connector
 3. Ceramic and stainless steel
 4. Butt-jointed and expanded-beam
- 2-50. What two mechanical splices are approved by the Navy?
1. Rotary mechanical splice and fused glass array
 2. LightCrimp splice and elastomeric splice
 3. Elastomeric splice and Fiberlok
 4. Rotary mechanical splice and LightCrimp

- 2-51. Which of the following is not a desirable feature of a connector?
1. Low loss
 2. Ease of installation
 3. Non contact
 4. Repeatable measurements
- 2-52. The standard connector for Navy light duty applications is of which of the following styles?
1. ST
 2. SMA
 3. Array
 4. Biconical
- 2-53. Light-duty connectors are intended for use in all but which of the following locations?
1. Interconnection boxes
 2. Equipment enclosures
 3. Environmentally protected locations
 4. Interconnection boxes and /or equipment enclosures
- 2-54. A standard connector for Navy heavy duty applications is of which of the following styles?
1. MIL-C-83526 connector
 2. MIL-C-28876 connector
 3. Biconical connector
 4. Array connector
- 2-55. In a heavy-duty connector, what are the two types of MIL-PRF 29504 termini called?
1. Plugs and adapters
 2. Type A and type B
 3. Pins and sockets
 4. Nuts and bolts
- 2-56. What type of cable has a connector only on one end and is spliced at the other?
1. Patch cord
 2. Pigtail
 3. Furcation unit
 4. Breakout cable

- 2-57. What is used with Blown Optical Fiber to build the 500 μ m acrylate fiber to a breakout cable configuration?
1. Patch cord
 2. Pigtail
 3. Furcation unit
 4. Breakout cable
- 2-58. What must a connector end face have to produce a PC finish?
1. Flat end face
 2. Pre-radiused end face
 3. Beveled end face
 4. Tapered end face
- 2-59. What are connector ferrules made of?
1. Plastic, ceramic, acrylate
 2. Ceramic, stainless steel, acrylate
 3. Acrylate, stainless steel, plastic
 4. Ceramic, stainless steel, plastic
- 2-60. Fiber optic couplers attenuate the optical signal much more than a connector or a splice.
1. True
 2. False
- 2-61. Active fiber optic couplers are called active fiber optic couplers for which of the following reasons?
1. Because they contain moving parts
 2. Because they switch the optical signal between different parts
 3. Because they contain active devices, including sources and detectors
 4. Because they move through the system
- 2-62. An optical coupler has one input port and two output ports. Which of the following types of couplers is it?
1. Optical splitter
 2. Optical combiner
 3. Star coupler
 4. Tree coupler

- 2-63. An optical coupler has two input ports and one output port. Which of the following types of couplers is it?
1. Optical splitter
 2. Optical combiner
 3. Star coupler
 4. Tree coupler
- 2-64. An optical coupler has one input port and several output ports. Which of the following types of couplers is it?
1. T-coupler
 2. Star coupler
 3. Tree coupler
 4. Optical splitter
- 2-65. An optical coupler has several input ports and several output ports. Which of the following types of couplers is it?
1. X-coupler
 2. T-coupler
 3. Star coupler
 4. Tree coupler

ASSIGNMENT 3

Textbook assignment: Chapter 5, "Fiber Optic Measurement Techniques,"
Chapter 6, "Optical Sources and Fiber Optic Transmitters".

- 3-1. What Navy document describes the detailed methods for testing optical installations on US Navy ships?
1. MIL-STD 2052
 2. NSTM Chap 408
 3. MIL-STD 2042()
 4. QPL
- 3-2. What test when completed takes ownership of a system?
1. Attenuation test
 2. Continuity test
 3. Acceptance test
 4. Ships operational verification test
- 3-3. What piece of test equipment uses a class 2 or 3 laser in the visual spectrum to check for breaks in a fiber?
1. Visual fault locator
 2. Optical loss test set
 3. Optical time domain Reflectometer
 4. Optical return loss meter
- 3-4. What is used to conduct a continuity test on a cable still on its reel or spool?
1. An OTDR
 2. A flashlight
 3. A VFL and bare fiber adapter
 4. An OLTs
- 3-5. In addition to dust, what other types of contamination must also be cleaned off a connector end face?
1. Oils (frequently from hands)
 2. Film residues
 3. Powdery coatings
 4. All of the above

- 3-6. Which magnification should only be used for checking for deep cracks?
1. 100X
 2. 200X
 3. 400X
 4. all of the above
- 3-7. Which of the following is not a benefit of the Proactive Inspection?
1. Reduced network downtime
 2. Increased Troubleshooting
 3. Optimized signal performance
 4. Prevention of network damage
- 3-8. What piece of test equipment is considered the “workhorse” for most fiber optic installation and repair efforts on US Navy ships?
1. OTDR
 2. VFL
 3. Flashlight
 4. OLTs
- 3-9. In order to ensure repeatable test results, Measureable Quality Jumpers (MQJs) are always required to be used when testing with the OLTs?
1. True
 2. False
- 3-10. What is used in a SOVT to establish pass/fail criteria?
1. Manufacturer’s test criteria
 2. Functional budget
 3. Loss budget
 4. Link loss
- 3-11. What is used when the system dynamic range figure is not available?
1. Maximum allowable loss
 2. Connector insertion loss
 3. Link attenuation allowance
 4. Cable attenuation loss

3-12. On an OTDR display loss is on the vertical axis and distance is on the horizontal axis.

1. True
2. False

3-13. The gradual slope on the OTDR display is called the power floor. How is the power floor created?

1. Is produced when the cutoff wavelength interacts with the cutback wavelength
2. When all the modes are excited
3. When light impacts small density changes in the core 13)
4. When the input pulse has a high amount of power

3-14. In addition to pulse width and wavelength, what other adjustments does the technician need to be aware of in order to get the best presentation on the OTDR screen?

1. Range
2. Index of refraction
3. Backscatter coefficient
4. All of the above

3-15. What function determines the output power of the OTDR?

1. Pulse width
2. Wavelength
3. Backscatter coefficient
4. Range

3-16. What value needs to be correct in order for the OTDR to accurately determine the length of a cable?

1. Range
2. IOR
3. Pulse width
4. Wavelength

3-17. How long is the typical dead zone eliminator?

1. 50 feet
2. 50 meters
3. 100 feet
4. 100 meters

- 3-18. Non-reflective events are caused by?
1. Connectors
 2. Splices
 3. Connectors and fusion splices
 4. Fusion splices and excessive bends
- 3-19. Reflective events are caused by?
1. Connectors
 2. Fiber ends
 3. Mechanical splices
 4. All of the above
- 3-20. To remove high-order modes in multimode fibers, which of the following mode filters is normally used?
1. Bessel filter
 2. Bandpass filter
 3. Mandrel wrap filter
 4. Neutral density filter
- 3-21. What is used in mechanical splices and crimp on connectors to match optical properties in the glass?
1. Index matching gel
 2. Index matching adhesive
 3. Mandrel wrap
 4. Encircle flux
- 3-22. What test determines if the Blown Optical Fiber microducts (tubes) are blocked or crushed?
1. Pressure test
 2. BB test
 3. Seal verification test
 4. Attenuation test

- 3-23. What is the function of a fiber optic transmitter?
1. To amplify optical signals and launch the amplified optical signals into an optical fiber
 2. To convert electrical signals into optical signals and launch the optical signals into an optical fiber
 3. To convert optical signals into electrical signals only
 4. To convert electrical signals into optical signals and transmit the optical signals through the air
- 3-24. What are the three parts of a fiber optic transmitter?
1. Source drive circuit, optical source and duplexer
 2. Interface circuit, source drive circuit and an optical source
 3. Modulator, source drive circuit and optical source
 4. Modulator, optical source and duplexer
- 3-25. An optical source has which of the following functions?
1. To convert light to electrical energy (current)
 2. To amplify the electrical signal
 3. To convert electrical energy into light
 4. To convert light into sound
- 3-26. Which of the following properties are NOT desired properties of an optical source?
1. Be compatible in size to low-loss optical fibers
 2. Emit light at wavelengths that maximize fiber loss and dispersion
 3. Maintain stable operation in changing environmental conditions
 4. Cost less and be more reliable than electrical devices
- 3-27. Fiber optic communication systems typically operate in what three wavelength windows?
1. 400 nm, 850 nm, and 1550 nm
 2. 400 nm, 900 nm, and 1400 nm
 3. 850 nm, 1300 nm, and 1550 nm
 4. 1300 nm, 2000 nm, and 4000 nm

- 3-28. What prevents the use of LEDs in long distance, high data rate applications?
1. Multimode fiber dispersion
 2. High fiber attenuation
 3. Low power output
 4. All of the above (chap. 6 page 3)
- 3-29. Why can't systems operating with an 850nm transmitter take advantage of graded index fiber's low intermodal dispersion?
1. High chromatic dispersion at 850nm
 2. Low chromatic dispersion at 850nm
 3. High waveguide dispersion at 850nm
 4. Low waveguide dispersion at 850nm
- 3-30. Semiconductor LEDs emit which of the following kinds of light?
1. Incoherent
 2. Coherent only
 3. Monochromatic only
 4. Coherent and monochromatic
- 3-31. Incoherent light has what type of lightwaves?
1. Lightwaves that are produced by lasers
 2. Lightwaves that lack a fixed-phase relationship
 3. Lightwaves that have a fixed-phase relationship
 4. Lightwaves that contain only one wavelength of light
- 3-32 . Semiconductor lasers emit which of the following kinds of light?
1. Spontaneous
 2. Incoherent
 3. Coherent
 4. All of the above
- 3-33. What is the preferred light source for multimode fiber?
1. Laser diode
 2. Vertical cavity surface emitting laser
 3. Light emitting diode
 4. Flashlight

- 3-34. All of the light emitted by a semiconductor laser or LED is coupled into an optical fiber.
1. True
 2. False
- 3-35. The amount of optical power coupled into a fiber is dependent on?
1. The angles over which the light is emitted
 2. The coupling characteristics of the fiber
 3. The alignment of the source and fiber and the size of the sources light-emitting area
 4. All of the above
- 3-36. What is it called when the fiber end face is directly placed over the source emitting region?
1. Butt coupling
 2. Lens coupling
 3. Evanescent coupling
 4. Fresnel coupling
- 3-37. What are the two most common semiconductor materials used in electronic and electro-optic devices?
1. Germanium and aluminum
 2. Silicon and gallium arsenide
 3. Indium and zirconium
 4. Zinc and platinum
- 3-38. LEDs produce light by what process?
1. Combustion
 2. Stimulated emission
 3. Spontaneous emission
 4. Photosynthesis
- 3-39. Lasers produce light by what process?
1. Combustion
 2. Stimulated emission
 3. Spontaneous emission
 4. Photosynthesis

- 3-40. Stimulated emission is the random generation of photons within the active area of an LED.
1. True
 2. False
- 3-41. In an optical source, the input electrical energy is converted to light and which of the following other forms of energy?
1. Gravitational
 2. Sound
 3. Heat
 4. All of the above
- 3-42. Which of the following components is NOT one of the basic types of LEDs used for fiber optic communication systems?
1. Surface-emitting LED
 2. Edge-emitting LED
 3. Super luminescent diode
 4. Avalanche photodiode
- 3-43. In low and moderate data rate applications, which of the following source types are typically used?
1. SLEDs only
 2. ELEDs only
 3. SLEDs and ELEDs
 4. Lasers
- 3-44. ELEDs only emit light through which facet?
1. Side
 2. Front
 3. Rear
 4. All of the above
- 4-45. Compared to SLEDs, ELEDs have all except which of the following properties?
1. Emit light in a narrower emission angle than SLEDs
 2. Couple more power into small NA fibers than SLEDs
 3. Emit power over a wider spectral range than SLEDs
 4. Are more temperature sensitive than SLED

- 4-46. Which of the following definitions best describes the term laser mode?
1. The condition of the laser, either lasing or not lasing
 2. The selected wavelengths that the laser emits
 3. The maximum modulation frequency possible for the laser
 4. The maximum angle of the emitted beam from the laser
- 3-47. The lasing threshold is the lowest drive current level at which the output of the laser results primarily from stimulated emission rather than spontaneous emission.
1. True
 2. False
- 3-48. What type of lasers are primarily used with fiber optics?
1. Inert gas laser diodes
 2. Direct coupled laser diodes
 3. Semiconductor laser diodes
 4. Indirect coupled laser diodes
- 3-49. Laser light differs from ordinary light in what ways?
1. Monochromatic
 2. Highly directional
 3. Coherent
 4. All of the above
- 3-50. Transmitters containing what source type, if any, will typically require the most complex circuitry?
1. SLED
 2. ELED
 3. LD
 4. None; all are roughly the same
- 4-51. Which of the following types of sources is typically the most temperature sensitive?
1. SLEDs
 2. ELEDs
 3. SLDs
 4. LDs

3-52. Lasers can be modulated at frequencies over?

1. 1 GHz
2. 10 GHz
3. 20 GHz
4. 100 GHz

3-53. The most common wavelength used with a VCSEL is?

1. 850nm
2. 1300nm
3. 1550nm
4. 2000nm

3-54. How is the output power of an optical transmitter coupled into fiber?

1. Through an intermediate optical fiber
2. Through a pigtail
3. Through a lens
4. All of the above

3-55. Typically, analog lasers operating at 1550nm are used in what application?

1. Analog audio systems
2. Single channel video systems
3. Cable television trunk lines
4. All of the above

ASSIGNMENT 4

Textbook assignment: ” Chapter 7, “Optical Detectors and Fiber Optic Receivers,” and Chapter 8, “Fiber Optic Links”.

- 4-1. Which of the following is NOT a typical part of a fiber optic receiver?
1. Optical detector
 2. Thermo electric cooler
 3. Low-noise amplifier
 4. Output signal conditioning circuitry
- 4-2. The term receiver sensitivity has which of the following meanings?
1. The minimum amount of optical power required to achieve a specific receiver performance
 2. The range of optical power levels over which the receiver operates within specified values
 3. The ratio of the output photocurrent to the incident optical power
 4. The wavelengths over which the receiver will properly operate
- 4-3. The term dynamic range has which of the following meanings?
1. The minimum amount of optical power required to achieve a specific receiver performance
 2. The range of optical power levels over which the receiver operates within specified values
 3. The ratio of the output photocurrent to the incident optical power
 4. The wavelengths over which the receiver will properly operate
- 4-4. An optical detector has which of the following purposes?
1. To convert an optical signal into an electrical signal
 2. To convert an electrical signal to an optical signal
 3. To amplify the optical output signal
 4. To generate an optical pulse proportional to the input current
- 4-5. Which of the following attributes is NOT a desirable attribute of an optical detector?
1. Be compatible in size to low-loss optical fibers
 2. Contribute high amounts of noise to the system
 3. Have a high sensitivity at the operating wavelength of the optical source
 4. Maintain stable operation in changing environmental conditions

- 4-6. In fiber optic systems, what are the principal types of detectors used?
1. Integrating spheres
 2. Photon counters
 3. Photomultiplier tubes
 4. PIN photodiodes and APDs
- 4-7. Which of the following factors does NOT affect the amount of current generated by a photodiode?
1. The responsivity of the photodiode at the wavelength of the incident light
 2. The data rate of the incoming optical signal
 3. The size of the photodiode active area relative to the fiber core size
 4. The alignment of the fiber and the photodiode
- 4-8. Which of the following terms is defined as the current produced by an optical detector because of the optical energy incident on its active area?
1. Photocurrent
 2. Active current
 3. Incident current
 4. Threshold current
- 4-9. The term detector responsivity has which of the following meanings?
1. The minimum amount of optical power required to achieve a specific receiver performance
 2. The range of optical power levels over which the receiver operates within specified values
 3. The ratio of the output photocurrent to the incident optical power
 4. The wavelengths over which the detector will convert light to electric current
- 4-10. The responsivity of an optical detector is constant over wavelength; that is, an optical detector does not absorb some wavelengths better than others.
1. True
 2. False
- 4-11. A PIN photodiode usually operates in what way?
1. Reverse-bias voltage applied
 2. Forward-bias voltage applied
 3. No bias voltage applied

- 4-12. What is the name of the current produced by a photodiode when no light is incident on the device?
1. Threshold current
 2. Spill current
 3. Photocurrent
 4. Dark current
- 4-13. Reverse-biased photo detectors are highly linear devices with respect to output photocurrent and input optical power.
1. True
 2. False
- 4-14. When compared to the reverse-bias voltage of a PIN photodiode, the reverse bias of an APD is which of the following sizes?
1. Much less than the PIN's
 2. About the same as the PIN's
 3. A little greater than the PIN's
 4. Much greater than the PIN's
- 4-15. The gain of an APD can be changed in what way?
1. By changing the data rate of the incoming optical signal
 2. By changing the reverse-bias voltage
 3. By changing the modulation format of the incoming signal
 4. By changing the input power of the optical signal
- 4-16. In a fiber optic receiver, what is the dominant contributor of electrical noise?
1. Optical detector
 2. Preamplifier
 3. Post amplifier
 4. Output circuitry
- 4-17. What action, if any, will maximize the sensitivity of a fiber optic receiver?
1. Minimizing the receiver noise
 2. Maximizing the receiver bandwidth
 3. Maximizing the receiver dynamic range
 4. None; no action will maximize sensitivity

- 4-18. In a fiber optic system, which of the following is NOT a typical source of noise?
1. Noise from the light source
 2. Noise from the interaction of light with the optical fiber
 3. Noise coupled in from adjacent optical fibers in a multifiber cable
 4. Noise from the receiver itself
- 4-19. Which of the following types of noise are introduced by the fiber optic receiver?
1. Thermal noise only
 2. Shot noise only
 3. Quantum noise only
 4. Thermal noise, shot noise, and quantum noise
- 4-20. How is thermal noise reduced in an APD?
1. Decreasing the value of the load resistor
 2. Increasing the value of the load resistor
 3. Limit receiver input
 4. Increase receiver input
- 4-21. What type of noise is considered shot noise?
1. Dark current
 2. Quantum noise
 3. Dark current and quantum noise
 4. Receiver noise
- 4-22. Which of the following are basic types of preamplifiers used in typical fiber optic receivers?
1. High-impedance and high-fidelity amplifiers
 2. High-impedance and transimpedance amplifiers
 3. High-fidelity and trans-impedance amplifiers
 4. High-impedance, high-fidelity, and transimpedance amplifiers
- 4-23. Compared to a high-impedance amplifier, a transimpedance amplifier provides all but which of the following improvements?
1. Sensitivity
 2. Dynamic range
 3. Bandwidth

- 4-24. For which of the following applications would a transimpedance amplifier typically be used instead of a high impedance amplifier?
1. Low-data-rate applications only
 2. Moderate-data-rate applications only
 3. Low- and moderate-data-rate applications
 4. High-data-rate applications
- 4-25. For which of the following applications would an APD rarely be used?
1. Low or moderate-data-rate applications
 2. Low- and high-data-rate applications
 3. Moderate- and high-data-rate applications
- 4-26. What type of fiber optic link consists of two simple point- to-point links transmitting in opposite directions?
1. Simplex link
 2. Full duplex link
 3. Composite link
 4. Total link
- 4-27. What type of fiber optic link is the basic building block of all fiber optic systems?
1. Point-to-point
 2. Point-to-central
 3. Branch
 4. Loop
- 4-28. What topology consists of a single transmission line that is shared by a number of equipments?
1. Linear bus topology
 2. Ring topology
 3. Star topology
 4. Tree topology
- 4-29. What topology consists of a transmission line that branches or splits?
1. Linear bus topology
 2. Ring topology
 3. Star topology
 4. Tree topology

4-30. What topology consists of equipments attached to one another in a closed loop?

1. Linear bus topology
2. Ring topology
3. Star topology
4. Tree topology

4-31. In what topology is each equipment connected to a common center hub?

1. Linear bus topology
2. Ring topology
3. Star topology
4. Tree topology

4-32. The first generation of fiber optic networks transmitted at what rate?

1. 10 Mbit/s
2. 100 Mbit/s
3. 100 Kbit/s
4. 128 Kbit/s

4-33. The original Ethernet standard was?

1. ITU-T G.983.1
2. ITU-T G.983
3. IEEE 802.3
4. MIL-STD 2042

4-34. Ethernet has no overall controller, how are the control functions handled in the network?

1. Random delegation
2. Remote terminal
3. Random intervals
4. Individual transceivers
- 5.

4-35. What does the Ethernet network do when a collision occurs?

1. Specifies a destination for every data signal
2. Resend the data to all terminals
3. Waits a random interval before trying again
4. Waits $1.8\mu\text{s}$ before resending the data again

- 4-36. How does the transceiver know it is the intended destination for the data sent?
1. A flag is sent along with the data
 2. An address header specifies the destination for every data signal
 3. Transceivers relay each other until the data finds the correct receiver
 4. Tokens are used to identify the correct data receiver
- 4-37. What is the maximum distance a signal can be sent over a single mode Ethernet network in half-duplex mode?
1. 1km
 2. 2km
 3. 2.5km
 4. 5km
- 4-38. Single mode fiber can send Gigabit Ethernet up to what distance?
1. 1km
 2. 2km
 3. 2.5km
 4. 5km
- 4-39. How does an end device in FDDI know it is the receiver when a message is sent?
1. Tokens are used as an authorization code
 2. Transceivers relay each other until the data finds the correct receiver
 3. Feedback circuit informs the receiver when the message is sent and received
 4. Nodes are sent to activate the intended receiver
- 4-40. How does Fibre Channel transmit its data?
1. In parallel
 2. In series
 3. In bands
 4. In links
- 4-41. What are the two basic classifications of fiber optic links?
1. High power and low power
 2. Return-to-zero and non-return- to zero line coded
 3. Digital and analog
 4. Amplitude modulated and frequency modulated

- 4-42. A digital signal can be defined as which of the following signals?
1. A continuous signal whose amplitude or some other property varies in direct proportion to some physical variable
 2. A discontinuous signal that changes from one state to another in discrete steps
 3. A signal generated by an electrical circuit
 4. A signal generated by a laser
- 4-43. Which of the following items is NOT an example of a digital line code?
1. Frequency modulation
 2. Non-return-to-zero
 3. Return-to-zero
 4. Manchester
- 4-44. What line code, if any, makes the most efficient use of system bandwidth?
1. Non-return-to-zero
 2. Return-to-zero
 3. Manchester
 4. None; all have the same efficiency
- 4-45. When compared to analog transmission, digital systems can tolerate which of the following conditions without affecting system performance?
1. Large amounts of signal loss and dispersion
 2. Source nonlinearities
 3. Effects of temperature on system components
 4. All of the above
- 4-46. An analog signal is defined as which of the following signals?
1. A continuous signal whose amplitude or some other property varies in direct proportion to some physical variable
 2. A discontinuous signal that changes from one state to another in discrete steps
 3. A signal generated by an electrical control circuit
 4. A signal generated by an LED

- 4-47. The typical method of source modulation for most analog fiber optic systems is what type of modulation?
1. Phase modulation
 2. Wavelength modulation
 3. Intensity modulation
 4. Pulse position
- 4-48. How many channels can a 1550nm band support using Wave Division Multiplexing?
1. 10
 2. 20
 3. 50
 4. 100
- 4-49. What is the maximum voice channels that OC-192 can carry?
1. 8,048
 2. 16,128
 3. 32,256
 4. 129,024
- 4-50. A course-wave WDM system can carry 10- Gigabit Ethernet up to 300 meters using 62.5/125 multimode step-index fiber at 1300nm and data up to 100km using single mode fiber.
1. True
 2. False
- 4-51. Which one of the following wavelengths is NOT used by Course-wave WDM transmitters?
1. 1300.0nm
 2. 1300.2nm
 3. 1324.7nm
 4. 1349.2nm
- 4-52. A passive optical splitter can divide a signal how many times?
1. 8
 2. 16
 3. 32
 4. 64

- 4-53. In a passive optical network, what are the splitters housed in?
1. Interconnection boxes
 2. Optical routing boxes
 3. Optical network terminals
 4. Fiber distribution hubs
- 4-54. The international PON standards specifies what wavelengths for downstream and upstream in the network?
1. 1310nm downstream and 1490nm upstream
 2. 1310nm downstream and 1550nm upstream
 3. 1490nm downstream and 1550nm upstream
 4. 1490nm downstream and 1310nm upstream
- 4-55. In addition to the standard two digital wavelengths that PON can carry what other wavelength can PON carry?
1. A 1550nm analog overlay to transport RF video
 2. A 1625nm analog overlay to transport both audio and video
 3. A 1550nm digital overlay to transport RF video
 4. A 1625nm digital overlay to transport both audio and video
- 4-56. What term or acronym identifies the subscriber equipment in a PON system?
1. Optical line terminal or OLT
 2. Fiber distribution hub or FDH
 3. Optical network terminal or ONT
 4. Optical distribution network or ODN
- 4-57. In a PON network the system architecture acts as a point-to-point network in the upstream and a point-to-multipoint in the downstream.
1. True
 2. False
- 4-58. Which of the following is NOT a competing standard with respect to PONs?
1. APON
 2. BPON
 3. GPON
 4. EPON

- 4-59. Which of the following statements is NOT correct?
1. APON uses ATM as its protocol
 2. BPON uses ATM as its protocol
 3. GPON uses Ethernet as its protocol
 4. EPON uses Ethernet as its protocol
- 4-60. Which of the following terms does NOT describe an aspect of fiber-to-the-premises?
1. FTTH
 2. FTTB
 3. FTTC
 4. FTTP
- 4-61. When installing fiber optic cables aboard Navy ships, which of the following precautions should you take?
1. Never bend an optical cable in a bend smaller than the cable's minimum bend radius
 2. Always clean fiber optic connectors before mating them
 3. Never pull a fiber optic cable over or through sharp corners or cutting edges
 4. All of the above

APPENDIX A

ABBREVIATIONS AND ACRONYMS

ALOFT- Airborne Light Optical Fiber Technology
ANSI- American National Standards Institute
Al- aluminum
APD- Avalanche Photodiode
APON- ATM Passive Optical Network
As- arsenic
ASP- Application Service Provider
AT&T- American Telephone and Telegraph
ATM- Asynchronous Transfer Mode
BER- bit error rate
BOF- Blown Optical Fiber
C- capacitance
CANES- Consolidated Afloat Networks and Enterprise Services
CATV- cable television
CD- Chromatic Dispersion
CID- Commercial Item Description
CLEC- Competitive Local-Exchange Carriers
cm- centimeter
CO- Central Office
CO₂- carbon dioxide
CPR- Coupled Power Ratio
CWDM- Course Wave Division Multiplexing
dB- decibel
DH- Double Heterojunction
DIP- Dual Inline Package
DS- Dispersion Shifted
DWDM- Dense Wave Division Multiplexing
EDFA- Erbium Doped Fiber Amplifier
EF- Encircle Flux
EIA- Electronics Industries Alliance
ELED- Edge Light-Emitting Diode
EMI- Electromagnetic Interference
EPON- Ethernet Passive Optical Network
FC- field connector
FCC- Federal Communications Commission
FDC- Fiber Distribution Center
FDH- Fiber Distribution Hub
FDDI- Fiber Distributed Data Interface
FDM- Frequency Division Multiplexing
FIB- Fiber Interconnection Box
FM- Frequency Modulation
FLLI- Fiber Land Line Interface

FOCP- Fiber Optic Cable Plant
FOCT- Fiber Optic Cable Topology
FODMS- Fiber Optic Data Multiplexing System
FOICB- Fiber Optic Interconnection Box
FOM- Fiber Optic Modem
FOTP- Fiber optics Test Procedure
FSAN- Full Service Access Network
FTTB- Fiber-to-the Building
FTTC- Fiber-to-the Curb
FTTH- Fiber-to-the Home
FWHM- Full-Width Half-Maximum
Ga- gallium
GAN- Global Area Network
Ge- germanium
GHz- gigahertz
GPON- Gigabit Passive Optical Network
GTE- General Telephone and Electronics Corporation
HAN- Home Area Network
IAW- in accordance with
IEEE- Institute of Electrical and Electronics Engineers
IM- Intensity Modulation
In- indium
IOR- Index of Refraction
ISNS- Integrated Shipboard Networking System
ITU- International Telecommunications Union
IVPO- Inside Vapor Phase Oxidation
Km- kilometer
LAN- Local Area Network
LASER- Light Amplification by Stimulated Emissions of Radiation
LC- little connector
LD- Laser Diode
LED- Light-Emitting Diode
LOMMF- Laser Optimized Multi-Mode Fiber
LSZH- Low Smoke Zero Halogen
m- meter
mb- megabytes
MAL- Maximum Allowable Loss
MAN- Metropolitan Area Network
Mb- megabyte/megabit
MCP- Multiple Cable Penetrator
MCT- Multiple Cable Transit
MCVD- Modified Chemical Vapor Deposition
MFD- Mode Field Diameter
MHz- megahertz
μm- micrometer
μW- microwatt

mm- millimeter
MM- multimode
mW- milliwatt
MPD- Mode Power Distribution
MQJ- Measurement Quality Jumper
NA- Numerical Aperture
Nm- nanometer
NEC- National Electric Code
NENP- No Epoxy No Polish
NTT- Nippon Telegraph and Telephone
NRZ- Non-Return-to Zero
NZ-DS- NonZero-Dispersion Shifted
OFCC- Optical Fiber Cable Component
OH⁻ hydroxyl ions
OLD- Optical Leak Detector
OLT- Optical Line Terminal
OLTS- Optical Loss Test Set
ONT- Optical Network Terminal
ORL- Optical Return Loss
ORLM- Optical Return Loss Meter
OTDR- Optical Time Domain Reflectometer
OVPO- Outside Vapor Phase Oxidation
P- phosphorus
PC- Physical Contact
PCM- Pulse Code Modulation
PCS- Plastic Clad Silica
PIN- Positive-Intrinsic-Negative
PMD- Polarization Mode Dispersion
PON- Passive Optical Network
PW- Pulse Width
QCC- Quick Connect Connector
QoS- Quality of Service
QPL- Qualified Products List
R- resistance
R&D- Research and Development
RC- Resistance Capacitance
RFI- Radio Frequency Interference
RMS- Rotary Mechanical Splice
RPL- Recommended Parts List
RX- receive
RZ- Return-to-Zero
s- second
SC- Subscriber Connector
Si- silicon
SiO₂- silica
SLD- Super Luminescent Diode

SLED- Surface Light-Emitting Diode
SM- single-mode
SNR- Signal-to-Noise Ratio
SOVT- Ship Operation and Verification Test
ST- Straight Tip or Single Terminus (military version)
SW- switch
SWAN- Ship Wide Area Network
TE- Transverse Electric
TIA- Telecommunications Industries Association
TIR- Total Internal Reflection
TO- cans transistor outline cans
TM- Transverse Magnetic
TRB- Tube Routing Box
TX- transmit
UV- ultra violet
V- normalized frequency
VAD- Vapor-Phase Axial Deposition
VCSEL-Vertical Cavity Surface Emitting Laser
VFL- Visual Fault Locator
VOD- Video On Demand
WAN- Wide Area Network
WDM- Wavelength Division Multiplexing

APPENDIX B

REFERENCES USED TO DEVELOP THE TRAMAN

NOTE: The following references were current at the time this TRAMAN was published, but you should be sure you have the current edition.

CHAPTER 1

Hecht, J. (1999). *City of Light*. New York: Oxford University Press

Hecht, J. (2002). *Understanding Fiber Optics*. Columbus, Ohio: Prentice Hall.

Goff, D. (2003). Brief History of Fiber Optic Technology. *Fiber Optic Video transmission*. Vocal Press: Woburn, Massachusetts

NAVEDTRA 14196. *NEETs Module 24 – Introduction to Fiber Optics*, (1998)

Sterling, D. (2000). *Technician's Guide to Fiber Optics*. New York: Delmar Learning

Training Guide for Fiber Optics Maintenance Technician, A-670-0063B Chg 2. Center for Surface Combat Systems Learning, Dahlgren, Virginia , 2013

Woodward, B. (2005). *Fiber Optics Installer and Technician Guide*. California: SYBEX Inc.

CHAPTER 2

Hecht, J. (1999). *City of Light*. New York: Oxford University Press

Hecht, J. (2002). *Understanding Fiber Optics*. Columbus, Ohio: Prentice Hall.

Naval Electricity and Electronics Training Series, *Introduction to Wave Propagation, Transmission Lines, and Antennas*, Module 10, Naval Education and Training Professional Development and Technology Center, Pensacola, Fla., 1983.

NAVEDTRA 14196. *NEETs Module 24 – Introduction to Fiber Optics*, (1998)

Sterling, D. (2000). *Technician's Guide to Fiber Optics*. New York: Delmar Learning

Training Guide for Fiber Optics Maintenance Technician, A-670-0063B Chg 2. Center for Surface Combat Systems Learning, Dahlgren, Virginia , 2013

Woodward, B. (2005). *Fiber Optics Installer and Technician Guide*. California: SYBEX Inc.

CHAPTER 3

Fiber Optic Cable Plant Installation Standard Methods for Naval Ships (Cables), MIL-STD-2042B(SH), Naval Sea Systems Command, Washington, D.C., 2002.

Hecht, J. (2002). *Understanding Fiber Optics*. Columbus, Ohio: Prentice Hall.

NAVEDTRA 14196. *NEETs Module 24 – Introduction to Fiber Optics*, (1998)

Sterling, D. (2000). *Technician's Guide to Fiber Optics*. New York: Delmar Learning

Training Guide for Fiber Optics Maintenance Technician, A-670-0063B Chg 2. Center for Surface Combat Systems Learning, Dahlgren, Virginia , 2013

Woodward, B. (2005). *Fiber Optics Installer and Technician Guide*. California: SYBEX Inc.

CHAPTER 4

Fiber Optic Cable Plant Installation Standard Methods for Naval Ships (Cables), MIL-STD-2042B(SH), Naval Sea Systems Command, Washington, D.C., 2002.

Hecht, J. (2002). *Understanding Fiber Optics*. Columbus, Ohio: Prentice Hall.

NAVEDTRA 14196. *NEETs Module 24 – Introduction to Fiber Optics*, (1998)

Training Guide for Fiber Optics Maintenance Technician, A-670-0063B Chg 2. Center for Surface Combat Systems Learning, Dahlgren, Virginia , 2013

Woodward, B. (2005). *Fiber Optics Installer and Technician Guide*. California: SYBEX Inc.

CHAPTER 5

Derickson, D. (1998). *Fiber Optic Test and Measurement*. New Jersey: Prentis Hall

Fiber Optic Cable Plant Installation Standard Methods for Naval Ships (Cables), MIL-STD-2042B(SH), Naval Sea Systems Command, Washington, D.C., 2002.

Hecht, J. (2002). *Understanding Fiber Optics*. Columbus, Ohio: Prentice Hall.

NAVEDTRA 14196. *NEETs Module 24 – Introduction to Fiber Optics*, (1998)

Training Guide for Fiber Optics Maintenance Technician, A-670-0063B Chg 2. Center for Surface Combat Systems Learning, Dahlgren, Virginia , 2013

CHAPTER 6

Dutton, H. (1998) *Understanding Optical Communications*, New York:

Hecht, J. (2002). *Understanding Fiber Optics*. Columbus, Ohio: Prentice Hall.

Goff, D. (2003). Brief History of Fiber Optic Technology. *Fiber Optic Video transmission*. Vocal Press: Woburn, Massachusetts

Figure 6-1 Light-emitting diodes - www.tpub.com

Figure 6-2 Light-emitting diodes - www.tpub.com

Figure 6-3 Laser diodes - www.tpub.com

Figure 6-4 Laser diodes - www.tpub.com

Figure 6-5 - www.advancedphotonics.wordpress.com

NAVEDTRA 14196. *NEETs Module 24 – Introduction to Fiber Optics*, (1998)

Training Guide for Fiber Optics Maintenance Technician, A-670-0063B Chg 2. Center for Surface Combat Systems Learning, Dahlgren, Virginia , 2013

CHAPTER 7

Dutton, H. (1998) *Understanding Optical Communications*, New York:

Figure 7-1 Optical Detectors and Fiber Optic Receivers - www.tpub.com

Figure 7-2 Encyclopedia of Laser Physics and Technology - p-i-n photodiodes
www.rp-photonics.com

Figure 7-3 Response Time – www.tpub.com

Figure 7-4 Near-Infrared Sub-Bandgap All-Silicon Photodetectors: A Review
www.article.sapub.org

Figure 7-5 Avalanche Photodiodes – www.tpub.com

Figure 7-6 Fiber Optic Receivers – www.tpub.com

Hecht, J. (2002). *Understanding Fiber Optics*. Columbus, Ohio: Prentice Hall.

NAVEDTRA 14196. *NEETs Module 24 – Introduction to Fiber Optics*, (1998)

Training Guide for Fiber Optics Maintenance Technician, A-670-0063B Chg 2. Center for Surface Combat Systems Learning, Dahlgren, Virginia , 2013

<http://encyclopedia2.thefreedictionary.com/Schottky+Barrier> *Definition of Schottky Barrier Photodiode*

CHAPTER 8

Cleary, D. (2010). *Fundamentals of a Passive Optical Network (PON)*, Optical Solutions, Inc.

Figure 8-14 Fiber Distribution Hub, FTTP – Next Generation Braodband Network Presentation, Verizon (2004)

Hecht, J. (2002). *Understanding Fiber Optics*. Columbus, Ohio: Prentice Hall.

NAVEDTRA 14196. *NEETs Module 24 – Introduction to Fiber Optics*, (1998)

Training Guide for Fiber Optics Maintenance Technician, A-670-0063B Chg 2. Center for Surface Combat Systems Learning, Dahlgren, Virginia , 2013